

APRIL 1985 • Volume 8 • Issue 4

£1.00

PRACTICAL COMPUTING

FOR BUSINESS AND PROFESSIONAL MICRO USERS



WORD PROCESSING FOR ALL

REVIEWS New IBM-compatible Wyse PC
Low-cost Tandy 1000 ■ WordStar 2000
PLUS Just how awful is One Per Desk?
Multi-tasking in Basic on the BBC B

REMEMBER

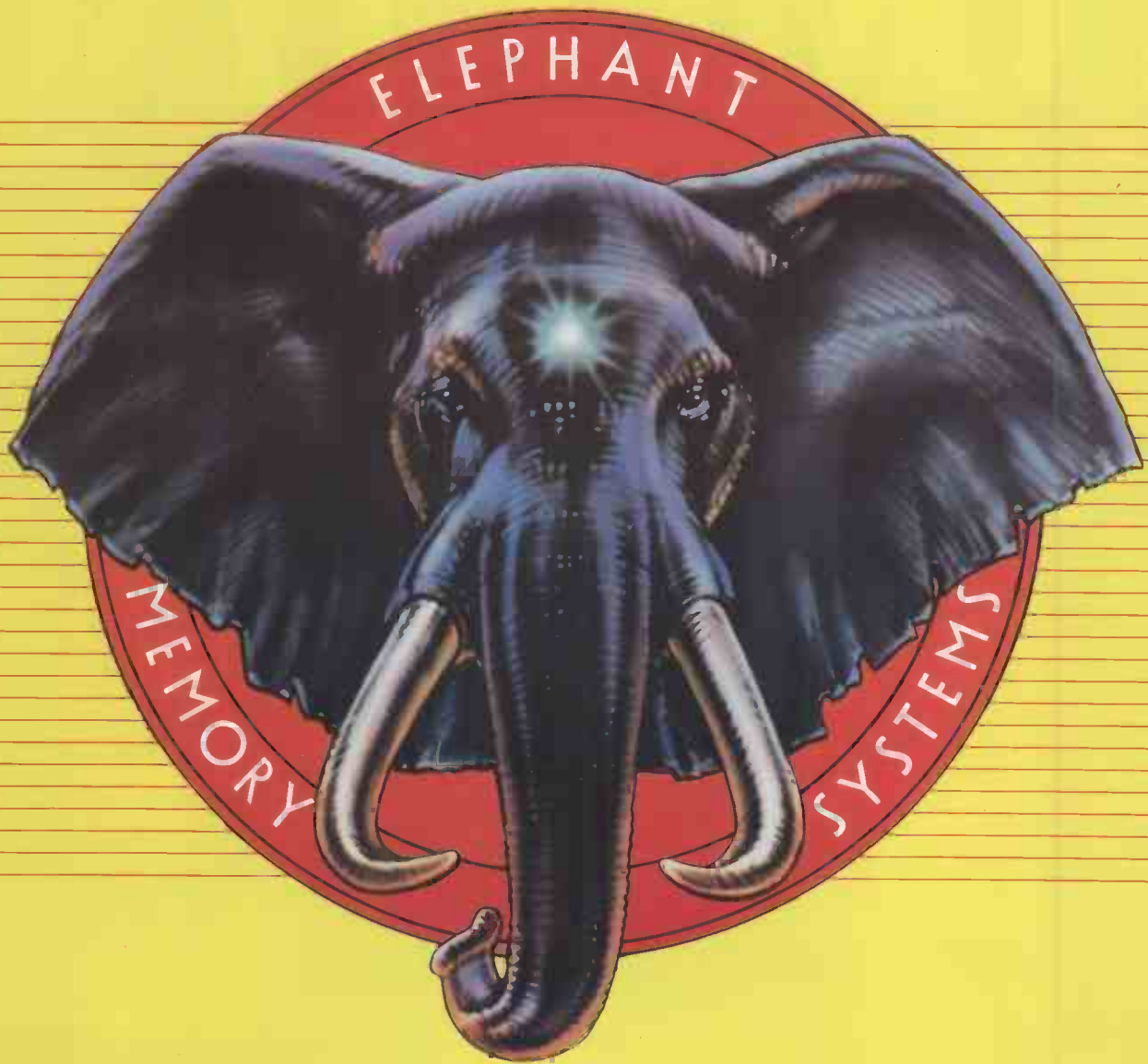

ELEPHANT NEVER FORGETS

Get the best from your computer with ELEPHANT disks. Certified 100% error-free and problem-free, and with quality maintained for at least 12-million passes, ELEPHANT disks are guaranteed to meet or exceed every industry standard and are compatible with virtually every computer on the market.



Look for the ELEPHANT sign at your local Dealers – or in case of difficulty, phone or write direct to Dennison Manufacturing Co. Ltd.

Dennison

Dennison Manufacturing Co. Ltd.

Colonial Way, Watford, Herts WD2 4JY, Tel: Watford (0923) 41244, Telex: 923321

France: Soroclass, 8, Rue Montgolfier - 93115, Rosny-Sous-Bois, Tel: 16 (1) 855-73-70

Germany: Marcom Computerzubehöer GmbH, Podbielskistr. 321, 3000 Hannover 1, Telex: 923818

Other Countries: Dennison International Company, 4006 Erkrath 1, Matthias-Claudius-Strasse 9, Telex: 858 6600

>LIST

PRACTICAL COMPUTING

APRIL 1985

>NEWS

15 HARDWARE NEWS

Apple dominates with its Appletalk LAN and Laserjet printer, along with cheaper Fat Macs and another QL disc drive.

21 IBM NEWS

A clutch of software keyboard enhancers and an Amos card to turn your PC into a multi-user machine.

26 SOFTWARE NEWS

Amstrad gets serious with CP/M, more for Sinclair's QL and a highly rated U.S. WP package.

29 GENERAL NEWS

The comings and goings of companies, together with some interesting books.

>WORD PROCESSING

103 WORD PROCESSING FOR ALL REASONS

Susan Curran discusses what makes a good WP package, and introduces five specialised areas.

105 For authors and journalists

106 Scientific and foreign text

107 Output that impresses

108 Boilerplating and mail-merge

109 Doing it on the cheap

110 ON THE MOVE

Jack Schofield investigates the feasibility of word processing on lap portables.

112 WORD PROCESSING ON THE MACINTOSH

Has the Mac changed the face of word processing? Ian Stobie tries out Macwrite, Macauthor and Word.

>FEATURES

92 MULTI-USER SYSTEMS

Multi-user databases are just what 16-bit micros were built for, according to Peter Laurie.

96 APPLICATIONS

Glyn Moody finds out how the London arm of a New York broker took the micro plunge.



99 TOP 10 PORTABLES

Your guide to the leading battery-powered portable micros, compiled by Ian Stobie.

118 BLACK HOLE CHESS

A variant of chess that includes bluff and uncertainty, discussed by David Levy in his programming series.

125 OPEN FILE

Details of our software for the BBC, IBM PC, Amstrad and Commodore machines.

126 BBC MULTI-TASKING

Run several applications at once on your BBC with David Elworthy's multi-tasking program.

133 CP/M FILE LISTER

John and Timothy Lee's utility lets you view files a screen at a time, and without any of the problems normally caused by control characters.

142 MORE ON THE BBC ROM

Roger Cullis offers more on what lies at the heart of the BBC Micro.

>REVIEWS



75 ONE PER DESK

Chris Bidmead plugs in to ICL's combined phone and micro professional work station.

78 TANDY 1000

A half-price colour IBMulator that is great for graphics. Jack Schofield looks for the catch.

80 WYSE PC

Robert Piper examines this sleek PC compatible. Is it as good as it looks?

84 WORDSTAR 2000

The long-awaited follow-up to the most successful word-processing package. Roger Cullis investigates.

88 dBASE II ADD-ONS

Mike Lewis finds life in the old database, with a host of third-party products and upgrades.

167 IBM BOOKS

The IBM boom extends to books on the subject, as Paul Myerscough finds out.

>REGULARS

5 EDITORIAL

Ten years old today — but where is the micro going now?

7 FEEDBACK

Your letters on the joys of the dongle, what Benchmarks really mean, and how to lock out hackers.

13 FEEDBACK EXTRA

Sorting out the problems that arise from rounding errors.

31 INTERVIEW

Will Jack Tramiel's ST machine make Atari the billion-dollar company of his dreams? Glyn Moody asks the questions.

35 CHIP-CHAT

Ray Coles looks at some blindingly fast video chips.

41 COMMS LINK

CompuServe's addictive CB Simulator described by Ben Knox.

43 SOFTWARE WORKSHOP

Mike Lewis squeezes more out of data compression.

57 ASK PC

John and Timothy Lee answer your questions.

173 LAST WORD

Are micros for learning or for creativity?

The Disk to launch a thousand programs

Here it is at last. One disk that will prove to be the solution for many business problems. A disk which will allow you to develop your own programs. Exactly the way you want.

The disk contains one of the most revolutionary programs of the year. Sycero. No matter whether you are a computer novice or a seasoned programming professional, Sycero enables you to build any type of business program.

No matter what your business. From traditional business applications like stock control, invoicing, database management and inventory to an unimaginable number of specific industry applications.

And the beauty of Sycero is that it takes no time at all to build a simple program for yourself. When you've built one, expanding it, or building other, more complex programs, is easy.

Once you start developing your own programs you'll wonder how you ever got on before. And no longer will you have to bend over backwards to make do because the program you bought off the shelf does things differently to the way you wanted.

No matter what your business, there's now one program for the job.

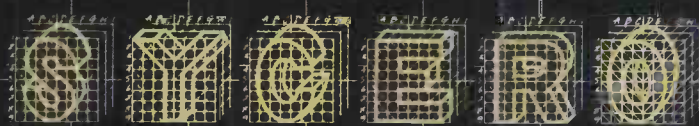

*The Businessman's
Program Builder*

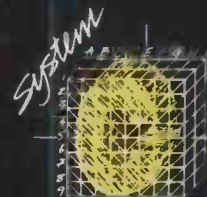

System C Limited
Tel 0622 55142

PRACTICAL COMPUTING

EDITORIAL 01-661 3609

Editor Jack Schofield
Assistant Editors Ian Stoble Glyn Moody
Art Editor Hugh Anderson
Production Editor John Liebmann
Sub-editor Carol Hammond
Editorial Secretary Sue Jordan

Consultants Chris Bidmead Peter Laurie

ADVERTISING 01-661 3612
Advertising Manager Nitin Joshi 01-661 3021

Assistant Advertisement Manager Neil Marchant 01-661 8626

Advertisement Executives Richard Milbourn 01-661 8100
Janet Thorpe 01-661 3468
Ian Walker 01-661 8425

Advertisement Secretary Joan Borrell

Midlands office David Harvett 021-356 4838

Northern office Geoff Alkin 061-872 8861

Classified Lucy O'Sullivan 01-661 8163

Group Advertisement Manager Shobhan Gajjar 01-661 8441

PUBLISHING DIRECTOR Chris Hipwell

Published by Electrical-Electronic Press, Quadrant House, The Quadrant, Sutton, Surrey SM2 5AS. Tel: 01-661 3500. Telex/grams 892084 BISPRS G.

Distributed by Business Press International Ltd, Quadrant House, The Quadrant, Sutton, Surrey SM2 5AS.

Subscriptions: UK £15.50 per annum; overseas £23.00 per annum; selling price in Eire subject to currency exchange fluctuations and VAT; airmail rates available on application to Subscriptions Manager, Business Press International Ltd, Oakfield House, Perrymount Road, Haywards Heath, Sussex RH16 3DH. Tel: (0444) 459188.

Printed in Great Britain for the proprietors Business Press International Ltd by Greenaway Harrison Web Offset Division, Southend-on-Sea. Typeset by Lithotype Design, London EC1.

© Business Press International Ltd 1985
ISSN 0141-5433

Would-be authors are welcome to send articles to the Editor but PC cannot undertake to return them. Payment is at £35 per published page. Submissions should be typed or computer-printed and should include a tape or disc of any program.

Every effort is made to check articles and listings but PC cannot guarantee that programs will run and can accept no responsibility for any errors.

Ten years on

THIS YEAR the microcomputer is 10 years old. The world's first real micro — though billed as a "minicomputer kit" — was the MITS Altair which was launched as a do-it-yourself project in the American magazine Popular Electronics.

By current standards the Altair was a little lacking in most departments. It did not have a screen, a keyboard or a Basic, and it only had 256 bytes — not a misprint — of RAM. What it did have was Intel's new \$367 8080 micro-processor and some lights and switches on the front. It was programmed directly in machine code, one byte at a time, by flipping the switches to represent binary 1s and 0s. The flickering lights were the output.

Of course, eventually the Altair acquired some powerful facilities. MITS's Ed Roberts hired a young lad called Bill Gates and his friend Paul Allen to write a Basic; it was supplied on punched paper tape but could be transferred to cassette. Then another young man, Intel employee Gary Kildall, wrote a disc operating system for the 8080; that was CP/M. Both were to become industry standards, as indeed did the Altair's system of construction, which lives on in the S-100 bus.

MITS's turnover hit a million dollars in its first year of computing, \$3 million in the next, and was on course for \$20 million in the third when it was taken over by Pertec. But by then a new kind of micro was becoming available: machines like the Apple, Commodore Pet and Tandy TRS-80 model 1. The companies that built them have grown to become billion-dollar corporations.

Software went through a similar development process. Word processing arrived with Electric Pencil in 1977, and the first spreadsheet with VisiCalc in 1979. Most of the programs were originally written by students — like the originators of VisiCalc — or hackers like the phone phreak Cap'n Crunch who wrote the Easy Writer word processor.

Now no one remembers that dBase II was going to be called Vulcan after Mr Spock in Star Trek — a programme which may have inspired the Altair name. Digital Research

dropped the "Intergalactic" from its title. Kentucky Fried Computer changed its name to the much more sober North Star, and so on.

The process accelerated when IBM entered the micro market at the end of 1981 with its 16K cassette-based IBM PC. IBM's entry was seen as legitimising micros, dragging in its wake the other mini and mainframe manufacturers, Burroughs, DEC, Data General, Sperry, Xerox, etc.

Together the hackers and the corporations created the rich mixture that constitutes the micro market today, the one we know and love. The question is, what happens next?

There would seem to be three major threads in the way the microcomputer industry is developing. First, the IBM PC and its emulator are growing into powerful systems that integrate into corporate computing, as well as being suitable for personal use.

Second, there is the alternative user-friendly way of doing things, best exemplified by the Apple Macintosh, forthcoming Atari ST models and Digital Research's Gem environment. They aim to make personal computer power available to more people through the use of mice and icons.

Third, thanks to continuing falls in the price of technology there is the chance to have really useful computer systems at very low prices. For example, Amstrad's awaited CPC-664 could provide a 64K machine with built-in disc drive, 80-column monitor, CP/M and WordStar for under £500.

After 10 years we are coming to the end of an era: the time when computers were mainly bought either for education or just for fun. In the next 10 years, computer buyers will ask what everyone else has been asking all along: "Yes, but what can it do?" Companies that have a sensible answer will find buyers willing to pay more for useful systems, rather than buy cheap ones that end up gathering dust. Companies that do not have a sensible answer will go the way of MITS, Imsai, Sol, Ohio and other firms that once dominated the industry but now are almost forgotten.

5 Years ago ...
A couple of times a week computing folk hold press conferences to announce some wonderful product. It is not seldom that they go like this: the managing director got up, got going and in five minutes had wound himself into a knot and crashed the system.
I got talking to the sales director and asked him how he proposed to sell his wonderful thing which cost a minimum of £50,000 a throw when it evidently didn't work, and moreover seemed to be up against a competitor which cost a fraction as much, and did work. "Ah", he said, his eyes glazed, his jaws chomping a morsel of smoked salmon, "that is an interesting question".
Afterwards, it seemed to us that they had done, badly, for half a million, what one of PC's contributors has done on his kitchen table — properly — for £300. There seem to be two rules in software production:
• Expense is completely optional — the same thing can cost hundreds, thousands, tens of thousands or hundreds of thousands;
• The more it costs the less well it works.

SOME SEARCHING QUESTIONS TO ASK A DATABASE MANAGER

Now that microcomputers are capable of serious data storage, the hot phrase in software is 'database manager.' A good one, such as Superfile, turns a micro into a hyper-intelligent filing cabinet, combined with an amazingly deft assistant.

Any business that uses a card index or a filing cabinet would benefit from a database manager. It could do more for an enterprise than hiring a new executive – but it is necessary to be just as careful when interviewing candidates for the job. Vast sums of money are lost by companies investing in software that doesn't work hard enough. So it's vital to ask the right questions – and get the right answers.

"ARE YOU CAPABLE OF DOING A WORTHWHILE JOB?"

"You may do well with a small database, but how much can you store? How fast are you when full?"

Superfile's capacity is limited only by the hardware. The 8 bit version is fast, but the 16 bit version is lightning. On a suitable machine it can find one Record out of a hundred thousand in 3 seconds. A lot of main-frame computers would like to do as well.

"DO YOU KNOW THE FACTS OF LIFE?"

"In real life, everyone changes their minds about the structure of their databases. Can you adapt? Can you hold many different sorts of information at once? Can you find someone who says they're called 'Smith' when they're actually 'ssmythe'?"

Superfile has a completely flexible structure. A user can change the shape of Records after he has started to enter data. He can store as many different kinds of Record as he wants. Superfile also has a unique 'sounds-like' searching facility – very useful for anyone who deals face to face with the public.

"ARE YOU ECONOMIC?"

"Do you insist on storing everything in fixed length spaces, so that 'Mr Ho' takes up as much room on the disk as 'Miss Featherstonehaugh-Willoughby-Fanshawe-Tupman'?"

Superfile has variable length Records that can double or treble the useful space on your expensive disks.

"ARE YOU FRIENDLY?"

"Do your users need a PhD in computer science? Are your manuals as thick as telephone books and as tedious to read?"



Superfile's underlying concepts are simple to understand. Its screen Forms for data entry can be set up in minutes. Its paper Reports are equally straightforward. The manuals are slim and concise.

"ARE YOU MULTI-USER?"

"A database is vastly more useful if several people can consult it at once. Can you cope with many hands on your keys without hysterics?"

Superfile is available in single and multi-user versions. Very few others can make this claim.

"CAN YOU KEEP PACE WITH TECHNOLOGY?"

"Hardware is changing and improving so fast – can you keep up with improvements? Or will all my database work be wasted when I buy a new computer?"

Superfile will run on anything from small 8 bit machines to main-frames. Users' databases will just move across without trouble.

"WILL YOU BE FAITHFUL?"

"Will you take my money and run? If I have problems will you help?"

Superfile's publisher, Southdata, is a family business committed to good customer relations. When users buy Superfile, they can be sure of individual attention and full technical support.

Superfile is an advanced, British made package. It runs on most modern micros and is widely used, among others, by the Ministry of Defence and British Telecom – organisations that do not have to settle for second best. To find out more about Superfile and how it could become a powerful member of your company, just send the coupon.

Please send me details of Superfile:

SUPERFILE
DATABASE MANAGEMENT

Name _____

Address _____

Phone _____

Or, you are welcome to ring us to make an appointment to see Superfile in action at our offices.

Southdata Ltd 166 Portobello Rd., London W11 2EB
01-727 7564 01-229 2724

PC4

Preventing software piracy

THE UNCOPYABLE DISC is a complete non-starter in the stakes of software protection. Copy-busting utilities abound, rendering the whole concept useless, and the move towards hard discs renders them inappropriate. A licencing system which requires voluntary restraint by the end-user is a joke — it's like leaving a child unattended in a sweet shop.

That leaves the dongle as the only suitable alternative. The only drawback is that dongles cannot at present be stacked or chained together, so you have to fumble around the back of the machine trying to pull a delicately pinned dongle on and off. If you have more than two or three dongles this is not an enviable task and rapidly becomes responsible for 50 percent of the "my computer won't work" claims.

The solution to this problem is to stack dongles on a dongle tablet in the same way that carriages make up a train. Each tablet would hold half a dozen dongles with the facility to chain a second tablet on to the end of the first tablet. Each tablet would be on the end of a short fly lead, and hence easily

accessible. All dongles would be on line at all times. The software simply checks that its dongle is present and ignores all the others.

The only remaining question is whether it be RS-232 or Centronics. Centronics would be better as the IBM PC has a Centronics port as standard — though unfortunately its pin-out is not standard. RS-232 is standard on nearly all computers but some IBM owners might have to buy another board.

If software houses would agree to a dongle standard then the current moans about software piracy would become a thing of the past. If the application software industry seriously wishes to claw back its £150 million of income lost to piracy then it should put its own house in order and not wait for politicians to do it for them. BSF and Dataview kindly take note.

Spencer Hall,
Accounting Software, Bristol.

Multi-column WordStar

IN YOUR January issue in "Feedback" in reply to R M Tobin you had said that you had no knowledge of software that could be used with WordStar to produce a multi-column printed text. Magic Bind by Computer Editype Systems of New York is just such a program.

It provides very good justification with proportional-spaced type, has many type-setting features, and the latest version includes mail-merge and address labels superior to many word-processing programs. The program has been in use in this college for the past year and we have found it simple to use with no problems.

J M Chapman,
Principal,
West Kent College
of Further Education,
Tonbridge.

Benchmarks

I HOPE to help place in context the timings for the HP 200/16 noted by Boris Allan. Implementation of the Motorola 68000 CPU with 16-bit memory accesses at 8MHz must contribute to the high performance of the HP Series 200 machines. It seems likely that HP Basic 2.0 shares some of the features found in the Basic of the HP 85.

The HP 85's Basic allocates or partially pre-compiles pro-

grams when first run or initialised. Notably, within the structure of an allocated program:

- Numbers are stored in BCD, not ASCII format.
- All expressions are stored, stacked and evaluated using reverse-Polish notation.
- Variable names are replaced by two-byte offsets; these offsets yield absolute addresses when added to the base address of the variable table.
- Line-number references are transported into absolute addresses.

All of these techniques seem to imply optimisation of Basic for efficiency. I may have misinterpreted some of these characteristics and would be interested if anyone could move towards providing a more thorough analysis of efficiency of Basic and of factors affecting the performance of micros.

R J R Morris,
London SW5.

BORIS ALLAN is a writer who arouses strong passions in *Practical Computing's* readers. Usually I dismiss the ire of his detractors and enjoy his well-

turned ripostes, but this time it is I myself who feels he has written at length to little avail.

In his article "Speed Freaks" in February's issue Boris discusses, with much statistical reference, the meaning of Life, the Universe, and Benchmarks 7 and 8. He concludes — and I dispute it not for a moment — that BMs 1 to 7 are strongly correlated, forming a group of tests all of the same kind, but that BM8 is quite different.

Is this surprising? A cursory examination of BM1 to BM7 shows that they are indeed all much the same, and clearly belong to a group. Roughly speaking, in order they:

1. Do a For-Next loop.
2. Increment a variable and do a Goto,
3. As 2, and perform simple arithmetic with two variables.
4. As 3, but do the arithmetic with constants.
5. As 4, including a Gosub.
6. As both 5 and 1, together with dimensioning a numeric array.
7. As 6, including filling the array.

But what about BM8? Quite

differently, effectively all it does is calculate powers and sine and log functions. The point is that the operations performed in BM1 to BM7 are built into the processor — with a little help from memory, the data and address buses, and so on. Those of BM8 are effected by the Basic.

Carrying out standard Basic commands like Goto and Gosub, and performing simple arithmetic, is primarily a hardware function, and the design of the software is relatively unimportant, though it may become the controlling factor when comparing machines with the same hardware. Powers, sines and logs, on the other hand, are usually calculated by summing appropriate series, and this is primarily organised by the maths package in the interpreter software, not by the hardware. You can therefore expect the results for BM1 to BM7 to be connected, and the result for BM8 to be quite unconnected.

To put things crudely, BM1 to BM7 indicate whether the chip designers knew their job, and to a lesser extent whether the machine's designers put it all together properly. BM8, on the other hand, shows the mettle of the writers of the system software, and whether they have chosen, and executed efficiently, the best algorithms for certain higher mathematical functions.

On one point I definitely
(continued on next page)

Our Feedback columns offer readers the opportunity of bringing their computing experience and problems to the attention of others, as well as to seek advice or make suggestions. Make sure you use Feedback — it is your chance to keep in touch. Write to:

Feedback, Practical Computing,
Quadrant House, The Quadrant,
Sutton, Surrey SM2 5AS

(continued from previous page)

agree with Boris: indiscriminate reference to the Benchmarks does not tell you which is the best all-round computer.

**J P Lindesay,
Marlow,
Buckinghamshire.**

● **Boris Allan replies:** My conclusion in the article was that BM1 to BM7 were all highly correlated, and one was almost as good as any other in discriminating between computers. BM7 was slightly more reliable because it took longer to run.

BM1 to BM7 do not reflect processor operations. To claim that the operations they perform are built into the processor assumes that it uses floating-point variables, that it has a For loop feature, or that it has a built-in Basic Goto.

If a 68000-series chip can perform arithmetic on 32-bit numbers, with hardware divide and multiply, then this has a tremendous effect on the speed of calculation of numerically intensive work, such as the calculation of series. For BM1 to BM7 the organisation of work is mainly controlled by the design of the Basic, but for BM8, using newer processors, the organisation of numerical work is simplified by the chip, and its calculation expedited.

What I find interesting is whether anybody ever checks the accuracy of the computations in BM8. That is a far more relevant and important test than a simple time trial.

Mr Men

WE AT MIRRORSOFT were delighted to see coverage given to our program Here and There with the Mr Men in your Early Learning feature in the

February issue. However, two of the three screen shots credited to Here and There were in fact from our third Mr Men program Word Games with the Mr Men, which comes in a special double cassette pack for the 48K Spectrum and Commodore 64. The two which were mistakenly credited were those featuring Mr Funny, Mr Silly and Mr Noisy. The one featuring Mr Tickle is the Here and There shot.

**Pät Bitton,
Mirrorsoft,
London EC1P 1DQ.**

ABM

IN THE NEWS announcement on page 21 of your February issue, under the heading of "More Compatibles", the contact given is incorrect. The company is ABM Computers Ltd, 12 Holder Road, Unit F, Aldershot, Hampshire GU12 4RH. Telephone: (0252) 334282.

**P Tucker,
ABM Computers Ltd,
Aldershot.**

Network security

THERE IS a very simple protocol that would exclude hackers from computer networks using telephone system. After verifying the pass number, the host computer requests the user computer's phone number, which it verifies against a list of authorised numbers. The user computer then generates a large random number, which it sends to the host computer; the host computer also generates a random number, sends it to the user, and then rings off.

The host computer then dials

the user computer and rechecks the pass number. The two computers then return the random numbers received in the first call, so that each computer should receive back the number it generated and sent during the first call. If the numbers tally, the link is opened.

This protocol has a further advantage. Anyone trying to access another computer has to give their own telephone number, and any computer linked to the system will be alerted if a hacker uses its code number. This will not make the system totally secure — nothing will do that — but it does mean that the criminal needs inside help to establish a password and phone number before gaining access to the system.

**Peter Thomson,
Kendal,
Cumbria.**

Amstrad Cat II

PETER PATON'S Cat II program for the Amstrad — January issue, page 158 — is most useful, but when I run it as listed the block number always prints as 1, even when Peek (47260) is greater than 1.

I think this fault must be due to an error in line 470, but as I do not understand the logic of this line I have left it alone and have altered line 600 to

```
PRINT " ";PEEK(47260)
The program now works perfectly.
```

**A J Snow,
Bushey,
Hertfordshire.**

THERE APPEARS to be a small bug in Peter Paton's Cat II program whereby block num-

ber is always displayed as 1. If in line 470 a temporary variable is tested and documented instead of BN, then the bug I think is cured.

```
469 N = BN
470 IF N > 1 THEN
    PLA = PLA - 2048:N = N - 1:
    GOTO 470
```

In experimenting with this program I found out the hard way about a pitfall lurking in the use of Break interrupt subroutines, invoked by the command On Break Gosub. While in a break interrupt subroutine, the Esc key appears to be disabled so that Break function itself is disabled; any On Break Gosub or On Break Stop commands issued in the break interrupt subroutine are effected, but only after Return from the subroutine.

**Charlie Thomas,
London SW12. ☒**

Advance 86

BRIAN H WHALLEY is trying to set up a user group to provide information and share experiences, expertise and problems. His address is Wordscope, Cold Well House, Walwyn Road, Colwall, Malvern, Worcestershire WR13 6RL.

Enterprise Benchmarks

THE TIMINGS for BM1 and BM2 in last month's review of the Enterprise — page 73 — were printed incorrectly. The Enterprise may be slow, but not quite that slow. The true timings are
BM1 2.0 (not 24.0)
BM2 9.0 (not 19.0)
The Average value was shown correctly as 68.5.



Now available
on Commodore
IEEE.

NO WAITING

Mon-Fri 
9-am 5-30pm



16K = £140.00
48K = £176.00
96K = £272.00
EX. VAT

Keep your micro motoring with a printer buffer

When you've invested some serious money in a micro system, why keep your system waiting while you print out your hard copy?

If you think about it, you must spend 1-2 hours every working day just waiting around – unless you invest in a printer buffer from Interface Systems.

Whatever micro you're using, our compact buffers simply plug into your system. So you can dump pages of text straight into the buffer, leaving your system free to carry on working for you – within seconds.

Every Interface System printer buffer comes with a full 90 day warranty. Yet they're still better value, bit for bit, than any other comparable buffer on the market.

We've made it simpler to get your hands on our buffer too – and our dealer network is still growing. Simply phone us direct for your nearest supplier, and start saving system time (and money) today.

Interface
Systems

Interface Systems, Interface House, 17 Eversley Road,
Bexhill-on-Sea, Sussex TN40 1HA.

Tel: 0424 225 683.

Northern Dealer: Interface Systems (Derby),
Norman House, Heritage Gate, Derby DE11DD.

Tel: 0332 364303.

Suitable for: Commodore · IBM · Digital Equipment Corp · Apple · Epson · Ricoh · Grid
Diablo · Anadex · ACT Apricot · ACT Sirius · TeleVideo · Torch · Superbrain · N.E.C. · Sharp
Corona · Morrow Designs · Sage · Olivetti · Triumph Adler · Tandy and many more.

THE BROTHER HR-15
DAISY WHEEL PRINTER

£445

(EX VAT)



Y
to t



All you require is a little peace and quiet. By the time you've finished reading, you'll be convinced that the HR-15, from Brother, is quite simply an outstanding printer at an exceptional price. That's not to say it's basic. Far from it.

Everything you want from a printer.

Daisy wheel, letter quality, and bi-directional printing at a speed of 13 cps (Shannon text), 18 cps maximum, is the platform upon which Brother have developed the HR-15. Making it an attractive proposition to business people and hobbyists alike.

Take the daisy wheel itself.

Available in a host of typefaces, it comes encased in a protective cartridge.

As much to guard it from manhandling and prolong its useful life as to save you from dirtying your fingers.

A small point, perhaps, but it's indicative of just how far Brother go into the planning of their machines.

Simple but ingenious ideas like a ribbon cassette that snaps into place, plus a separate red ribbon.

Ingenuity that extends as far as a family of compatible accessories.

At the touch of a button, the HR-15 can be set to continuously print whatever is stored in its 3K buffer. Making form letters and document duplicates no problem at all. It also leaves your computer free for other operations. To clear the buffer for new text, all you do is re-press the same button.

The HR-15 boasts proportional spacing which eliminates unsightly gaps between characters, giving a uniform appearance and highly professional finish.

For those final touches that give your print-out that something extra, the HR-15 can print in two colours, shadow print and underline.

All carried out automatically during the print run, as instructed by your program.

Should that program be of a scientific or unusual nature, the HR-15 can take it in its stride. Fractions, exponential or any other characters that require special treatment are dealt with by its super and sub script facility.

There's even an impact control to vary the character arm pressure on the paper, which is ideal for making carbon copies.

Taking the worry out of interface.

An impressive array of capabilities which is equalled by interface and DIP switch options, thereby extending the versatility of its operation.

At no extra cost, the HR-15 offers a choice of either a Centronics parallel or an RS-232C interface, and it's compatible with almost all the micro computers currently available.

There you have it; the Brother HR-15, its facilities, its simple plug-in accessories and its interface connections.

And for a price that gives you a lot more than you probably bargained for.

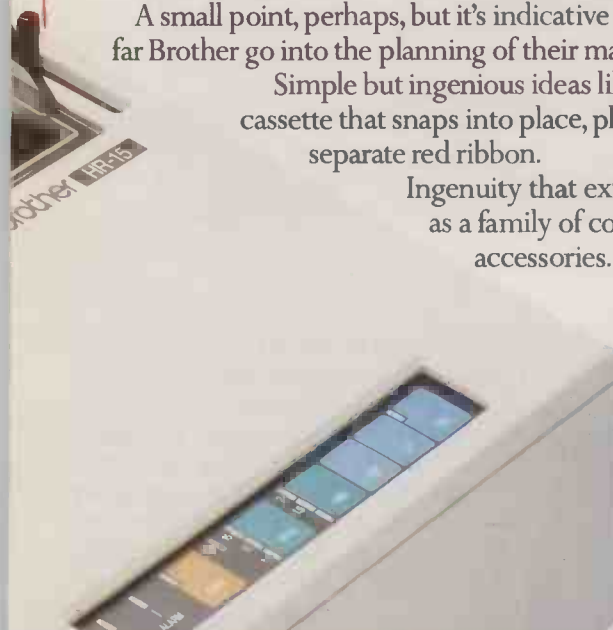

You don't need a computer telling you which printer to buy.

More specifically, the TF-50 tractor feeder for continuous paper feed.

The CF-50 cut sheet feeder for word processing and letter use. It can automatically feed 150 sheets of A4 size paper, and the movable roller guide allows you to slip in a different sized sheet without removing the unit.

Finally, an invaluable attachment for all small businesses, the KB-50 keyboard.

The KB-50 transforms the HR-15 into a sophisticated electronic typewriter.

Allowing the HR-15 to be of more use around the office than a lot of its competitors in the printer market. And, as with all of the Brother accessories, the price adds to the HR-15's economic performance.

Sophisticated operations at your fingertips.

As the functions, by necessity, become more complex, Brother have kept their operation as simple as possible.

PLEASE SEND ME MORE DETAILS OF THE BROTHER HR-15 PRINTER AND ITS RANGE OF ACCESSORIES.

NAME _____

POSITION _____

COMPANY _____

ADDRESS _____

TEL. NO. _____

PC/4/85



The future at your fingertips.

DEPT. P, BROTHER OFFICE EQUIPMENT DIVISION, JONES + BROTHER, SHEPLEY STREET, GUIDE BRIDGE, AUDENSHAW, MANCHESTER M34 5JD.
TEL: 061-330 6531 (10 LINES), 061-330 0111 (6 LINES), 061-330 3036 (4 LINES)

TELEX: 669092

BROTHER INDUSTRIES LIMITED, NAGOYA, JAPAN.

INTEGRATED, HIGH PERFORMANCE, EXPANDABLE & COST EFFECTIVE

Multi-User Computer

LOOK AT YOUR CHOICE OF TECHNOLOGY BEFORE CHOOSING YOUR MACHINE

STOP PRESS!
IMPOS now supports genuine multi-user MS-DOS as well as Concurrent CP/M 3.1, CP/M 2.2 and CP/M 86 simultaneously in any combination for up to 16 users

An Obvious Choice...

Time Sharing Micros

Typical multi-user micro machine are doomed by CPU degredation being based on time-sharing principles. Altos, Fortune and IBM PC/AT are in this class.

An Alternative Choice...

Networked PC's

Networks are too expensive and tedious. They do not offer a truly integrated multi-user system or speed. Networked IBM PC's and Apricot are such examples.

The Wise Choice... Multi-Processing

The choice you didn't know you had . .

In Multi-processor SuperStar, each user has its own dedicated processor with up to 1Mbyte of RAM each, working at full CPU speed regardless of the number of terminals. The tremendous increase in power resulting from having up to sixteen 16-bit processors compared with time-sharing a single processor must be plain. Because it is a network on an internal bus, it is very much faster than conventional serial networks — yet it is much less expensive because all the processors are integrated into one desk-top unit instead of being distributed among the various PCs

SuperStar is a genuine multi-user system with record/file locking and with printer spooling. All MS-DOS and CP/M (all variants) programs run without modification. It is ideal for a cost-effective Office Automation system for any or all of the following functions in any combination.

- ★ *Word Processing and Spread-sheets*
- ★ *Database and Information Management*
- ★ *Telex, Electronic Mail and Communications*
- ★ *Genuine Multi-user Data Processing, such as Stock Control, Order Processing, and Integrated accounts.*



417-421 Bromley Road, Bromley, Kent BR1 4PJ
Tel: 01-697 8933 Telex 896691 TLX1RG



Rather than slow time-sharing micros or expensive networked PC's more and more companies are choosing multi-processing to meet their multi-user requirements, including:

BUPA*, BRITISH TELECOM, HILL SAMUEL*, MORI, PHILIPS*, MONSANTO, SOUTHAMPTON UNIVERSITY, BROMLEY HEALTH AUTHORITY, BANHAM ALARMS* AND MANY MORE.

SuperStar



*Case studies of their installations are available on request.

SuperStar is a trade mark of Bromley Computer Consultancy. CP/M is a trade mark of Digital Research. MS-DOS is a trade mark of MICROSOFT.

SuperStar-16 has a 16-bit Master Processor which runs IMPOS (BROMCOM designed true 16-bit controlling operating system) IMPOS supports CP/M, MS-DOS and shortly Xenix in slave processors in any combination and it is fully upward compatible with ACTION DPC/OS, TeleVideo MmmOST and TurboDOS

JUST LAUNCHED! MULTI-USER MS-DOS

MS-DOS is an established 16-bit operating system for a single user PC. BROMCOM has incorporated MS-DOS 2.11 into SuperStar-16/MS to offer a genuine multi-user environment through multi-processing. This development opens the door to a tremendous opportunity for exploiting the widely available applications software developed in MicroSoft Basic (MBASIC) which can run only under MS-DOS in 16-bit. Record and file locking are fully upward compatible with Televideo M m m O S T , D P C / O S , TurboDOS and MP/M. Floppy disks are compatible with IBM-PC and full PC-DOS compatibility will be available early in 1985.

16-BIT MASTERS/ SLAVES



In a given configuration, say 8-users (maximum 16 — more with networking), SuperStar has eight 16-bit slave processors, each with up to 1Mbyte RAM, and an additional 16-bit Master processor also with up to 1Mbyte RAM. All processors are iAPX186 with optional 8087 co-processors. This demonstrated the immense power and capacity of the system against time-sharing systems where a single processor serves all eight (or more), users. SuperStar's multi-processor architecture also enables each user to choose his own different operating systems environment, e.g. CP/M or MS-DOS — one more of the superior features that cannot be found in other systems.

INTEGRAL 1/4in CARTRIDGE TAPE BACKUP

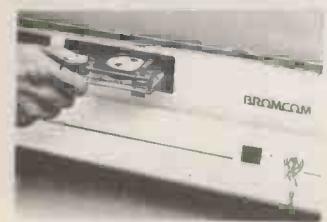

SuperStar-16 has an optional tape backup facility, totally integrated in the system and built into the desk-top unit.

SuperStar-16 must be one of the most powerful, flexible and complete systems available on the market.

For information see opposite page.

Feedback extra

One of the most insidious problems presented to programmers is where wrong answers are produced because of a failure to allow for the effects of rounding in calculations. The following letter is typical, and the problem is so important and so widespread we have asked John and Timothy Lee to deal with it in detail.

A question of accuracy

A NASTY bug comes with simple arithmetic in MBasic. Take the simple program

```
10 DEFDBL A,B,C,D
20 DEFDBL A,B,C,D
20 B = 9999: C = 123456:
   D = 0.0123456789
30 X = 9999: Y = 123456:
   Z = 0.0123456789
```

There are four ways of writing

```
A = 9999*9999*9999*9999
using all possible combinations
A = C + D,   A = C + Z,
A = Y + D   and   A = Y + Z.
Printing A gives three different answers.

```

Similarly, there are 16 ways of writing

```
A = 9999*9999*9999*9999
using all combinations of B
and X; 12 ways give the correct answer. I defy anyone to predict which are the correct 12.
```

R G Silson,
Tring,
Hertfordshire.

● **John and Timothy Lee reply:** Any arithmetic operation, will be performed in the highest precision of the two numbers being processed. If both numbers are single precision, the sum is performed in single precision. If one or both is double precision, the sum is performed in double precision.

Mr Silson's observation that three different values of A are obtained can be explained theoretically. We have observed the theoretical results using six different versions of Microsoft Basic on different micros.

In the program shown in listing 1 the addition will be performed in the highest mode of either of the operands, so if both are double precision, the sum will be done in double precision. If one number is double precision and the other single precision then double precision will be used.

However, if both numbers are in single precision then the addition will be carried out in single precision and the least significant figures will be dropped in the addition. Even if the answer is then stored in a double-precision variable, it is too late. Only the seven most

Listing 1.

```
10 DEFDBL A,B,C,D
20 C=123456: D=0.0123456789
30 Y=123456: Z=0.0123456789
40 PRINT "C+D both double precision"; C+D
50 A=C+D: PRINT A
60 PRINT "C+Z one double one single ie mixed mode"; C+Z
70 A=C+Z: PRINT A
80 PRINT "Y+D one single one double ie mixed mode"; Y+D
90 A=Y+D: PRINT A
100 PRINT
110 PRINT "Y+Z both single precision"; Y+Z
120 A=Y+Z: PRINT A
```

significant figures are kept and the least significant figures may be filled with any garbage that was there previously.

You might expect lines 40 to 90 to give the same accurate answer, and for lines 110 and 120, which are adding single-precision Y to single-precision Z, to give different rounded answers. This is not the case. The run produces

- C + D both double precision
123456.0123456789
- 123456.0123456789
- C + Z one double one single, ie mixed mode
123456.0123456791
- 123456.0123456791
- Y + D one single one double, ie mixed mode
123456.0123456789
- 123456.0123456789
- Y + Z both single precision
123456
- 123456.015625

As expected, C + D and Y + D are accurate, and Y + Z has been rounded. So why has C + Z yielded a slightly inaccurate result?

Z is a single-precision variable, and though line 30 sets Z to 0.0123456789 not all of these digits can be stored in single precision. Try adding

```
35 PRINT Z
```

to see what is really stored. It is the truncation at this stage that has produced the strange value for C + Z.

Mr Silson's second problem concerns the 16 different ways of writing

```
A = 9999*9999*9999*9999
```

The sum boils down to evaluating

```
B*B*B*B*
```

or

```
X*X*X*X,
```

and all the other combinations, as in listing 2. Remember the

Listing 2.

```
10 DEFDBL A,B
20 B=9999
30 X=9999
40 A=B*B*B*B: PRINT "B*B*B*B"; A
50 A=B*B*B*X: PRINT "B*B*B*X"; A
60 A=B*B*X*B: PRINT "B*B*X*B"; A
70 A=B*B*X*X: PRINT "B*B*X*X"; A
80 A=B*X*B*B: PRINT "B*X*B*B"; A
90 A=B*X*B*X: PRINT "B*X*B*X"; A
100 A=B*X*X*B: PRINT "B*X*X*B"; A
110 A=B*X*X*X: PRINT "B*X*X*X"; A
120 A=X*B*B*B: PRINT "X*B*B*B"; A
130 A=X*B*B*X: PRINT "X*B*B*X"; A
140 A=X*B*X*B: PRINT "X*B*X*B"; A
150 A=X*B*X*X: PRINT "X*B*X*X"; A
160 PRINT "LINES BELOW ALL HAVE SINGLE PRECISION STEP"
170 A=X*X*B*B: PRINT "X*X*B*B"; A
180 A=X*X*B*X: PRINT "X*X*B*X"; A
190 A=X*X*X*B: PRINT "X*X*X*B"; A
200 A=X*X*X*X: PRINT "X*X*X*X"; A
```

order in which arithmetic is performed.

1. inside brackets
2. raising to powers
3. *, /
4. +, -

If there is more than one step possible at the same level of precedence then the calculation starts at the left and proceeds to the right.

Since X is a single-precision variable, the only time single-precision multiplication can occur with consequent rounding is if the line of arithmetic starts with X*X..., or X*X*X..., or X*X*X*X. There are four such cases out of the 16, namely, X*X*B*B, X*X*B*X, X*X*X*B and X*X*X*X. These will give incorrect, rounded answers.

We would expect the first 12 results in listing 2 to be accurate, the next two identically inaccurate, and the final two different again.

Finally, there is no absolute guarantee that a compiler — particularly an optimising compiler — will do the arithmetic in the same order as described, so it may give different answers in mixed-mode arithmetic. □

TOP VALUE from **NEC...**



2.4Mb!

the **ADVANCED Personal Computer (APC)** from only **£1,735 + vat** including **MSDOS + WORDSTAR + MULTIPLAN**

STANDARD FEATURES

- * **SPEED:** full 5 MHz 8086 16 bit processor (true 16 bit data).
- * **CAPACITY:** One or two 8" disks (1.2 Mb each formatted under MSDOS)
- * **MEMORY:** 128K user RAM + screen RAM + system ROM + battery-backed CMOS non-volatile RAM & clock/calendar.
- * **OPERATING SYSTEMS:** MSDOS 2.11 or CPM-86 or CONCURRENT DOS (CPM).
- * **HIGH RESOLUTION:** 8 x 19 dot character screen definition, (25 lines of 80 characters + 26th system status line), 12 inch green screen.
- * **AWARD WINNING NEC 7220 graphic chip** In character mode. 256 standard character set includes maths/greek & graphic symbols. **ADDITIONAL 256 USER-PROGRAMMABLE** shape character set(s). GSX graphics standard.
- * **DETACHABLE KEYBOARD:** Fast buffered 61 key + 25 key numeric/cursor pad + 22 dual mode function keys with labelling facility (16 of which will each hold two 15 character user-defined strings).
- * **SERIAL RS-232:** Up to 19,200 baud synch/asynch. **PARALLEL** printer.
- * **SUPERB MANUALS:** operating level to full technical spec (US written).
- * **COMPACTNESS:** 19 inches wide, 24 inches deep, 14 inches high.
- * **PRICE:** unbelievable for the quality of this product from the mini-computer division of NEC (world's 3rd largest micro manufacturer).

OPTIONAL EXTRA FEATURES

- * **EXPANDABLE USER MEMORY:** in 128k units to 512k RAM.
- * **HARD DISKS:** one/two (10-20 MB formatted), floppies ideal for backup.
- * **8 COLOUR SCREEN.**
- * **VERY HIGH RESOLUTION GRAPHICS:** 640 x 475 x 8 colour or mono screen from 1024 x 1024 x 3 bit mapped array (384k extra RAM!). Hardware draw, pan & zoom using 2nd NEC 7220 controller. Fast! Macro shape generation etc.
- * **32 BIT HARDWARE ARITHMETIC PROCESSOR:** 8087.
- * **CONCURRENT CPM NOW AVAILABLE.**
- * **8 BIT Z80 CARD NOW AVAILABLE** for dual standard 8 & 16 bit, 64k RAM, RAM DISK facility within user memory.

SOFTWARE

ALL GENERAL CPM-86 AND MSDOS SOFTWARE
 AUTO CAD graphic design package.
 CUSTOMISED software packages to your requirements for less than the price of a typical inflexible standard package — details on request.
 ACCOUNTS: Own bespoke packages at two levels, SYSTEMATICS, MULTISOFT.
 WORD PROCESSING: NEC Benchmark, Spellbinder, Wordstar, etc.
 DATABASE: DBASE II, Rescue, Datastar, Friday! etc.
 LANGUAGES: C, CB-86, CBASIC-86, Microsoft BASIC, COBOL, FORTRAN, PASCAL, PL/1, etc.
 COMMUNICATIONS: Asynch, IBM: Bisync 3780, 3270, HASP.

Brighton Computer Centre

130 Lewes Road, Brighton BN2 3LG
 (0273) 673114 Mon-Sat 10am-6pm

Please send me further details of the NEC APC.

Name

Company

Address

..... Tel

ApplicationPC4/85

● Circle No. 176

ARE BUSINESS COMPUTERS A MYSTERY TO YOU?

RING
01-337 4541



HIGH QUALITY,
 LOW COST COMPUTERS
 and PRINTERS

FREE
CONSULTATION
Concordia

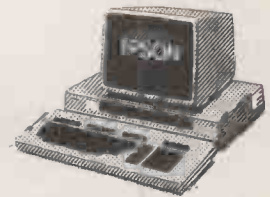

6 CENTRAL ROAD, WORCESTER PARK, SURREY KT4 8HZ

● Circle No. 167

THE ASSOCIATION OF LONDON COMPUTER CLUBS PRESENTS



RESERVE THE DATES NOW!
 THE CULMINATING EVENT
 OF THE

The Personal Computer
 Show for **EVERYONE**
 Further information
 from **PATRICIA SPILSBURY**
 01-303 8849



COMPUTING FOR LONDON.

Apple assault

APPLE entered 1985 with announcements of record sales and profit levels, two new products and a new name for an old friend. Sales for the first quarter of the fiscal year 1985 were nearly \$700 million, an increase of 46 percent over the previous year's figure. Profits were up 50 percent to \$46 million.

As part of its next assault on the corporate market, Apple has announced Appletalk for the Macintosh and related peripherals. This bus-type network allows up to 32 users to communicate over 1,000ft. A twisted-pair cable is used to carry the data at 230Kbit per second. Since most of the LAN hardware is already present in the Mac, installation costs are only \$50 per connection. No U.K. price has been announced yet and first shipments are expected in June.

Appletalk controls traffic using the software protocol CSMA/CA, which stands for carrier-sense multiple access

with collision avoidance. It is designed to allow all devices to compete equally for access to the cable. Under this system, a computer or peripheral which has data to transmit first tests whether the line is free or not. If a line is free, the device waits another 400ms. before reserving the line with a quick handshake process.

New products under development include hardware devices that connect Apples to IBM PCs, an Appletalk interface to the Ethernet LAN and gateways to IBM networks. All peripherals designed for use with the network will have most of the Appletalk architecture built-in.

The Laserwriter has already been released. It is a high-resolution laser printer, built around hardware from Canon like Hewlett-Packard's Laserjet discussed in last November's *Practical Computing*. The resolution is 300 dots per inch, and the throughput is up to eight pages per minutes. But



The Apple Laserwriter offers resolution of 300 dots per inch.

whereas the Hewlett-Packard machine costs about £3,000, the Laserwriter costs nearly \$7,000. The price differential is partly explained by the heavy processing power it contains. Apple even claims it to be its "most powerful computer". In addition to a 12MHz 68000, there is 512K RAM and 512K ROM.

Another new name from Apple proves not to be so new. The Macintosh XL is in fact the Lisa 2/10, which comes with 512K RAM and a 10Mbyte Winchester. The cost is £3,995. The old Lisa 2 and Lisa 2/5 will be phased out.

Finally, Apple has decided to make a bid for the U.K.

education market in earnest. Under the banner of "Our Kids Can't Wait", Apple is offering a 50 percent discount on the Apple IIc and on Apple IIe machines fitted with one or two disc drives. Any number of the machines can be purchased.

Apple has a million machines installed in educational establishments worldwide, and is looking to oust Acorn now that the Government's funding scheme has ended. Apple states provocatively that its desire is "to make up lost ground caused by the use of the wrong machine in the past."

Apple can be contacted on (0442) 60244.

Macdrives

A RANGE of Winchester and removable Winchester discs built by Tecmar is available from First Software. They all communicate with the Macintosh via the RS-422 port. An additional RS-422 port on the back on the Macdrive cabinet leaves the modem port free. Each unit contains a 68000 processor with 128K RAM which serves as a buffer.

In addition to ordinary hard discs there are removable versions. The 5Mbyte removable and 10Mbyte fixed discs cost £1,790, and the 10Mbyte fixed with 5Mbyte removable and the double 5Mbyte removable cost £2,990. More on (0256) 463344.

Modems keep coming

APPROVED MODEMS continue to arrive with decreasing prices. Telemod 1 operates at 300 baud and offers auto-answer. It also

includes a built-in supply. The unit is produced by OE Limited on (0768) 66748.

The Answercall 100 Mini Modem from Answercall costs



£86.25 and also operates at 300 baud.

The Advanced Intelligent Modems from Timeplex offer a number of modems with speeds ranging from 300 baud to 2,400 baud. Costs start at £155. Timeplex is on (0423) 61317.

Crystalet

THE CRYSTALET from Aston Technology offers a one- to three-user system that is fully

compatible with the range of larger Crystal machines. The new model offers a 68000 running at 10MHz, 256K RAM expandable up to 1Mbyte, four RS-232 ports, a 1Mbyte floppy and a 10.5Mbyte Winchester. Four operating systems and some 10 languages can be run. The cost starts at about £5,750. Telephone: 021-359 4861.

Channel 4 telesoftware

A TELESOFTWARE adaptor for use with the software which is broadcast on Channel 4's teletext has been produced by OE Limited. The unit currently only works with the Spectrum but there are plans to produce versions for the BBC and Commodore 64 in April and May respectively.

The unit allows you to not only view teletext information but to download the 10 alternating pages of software to be found on page 453 of the service. The cost is £125. More information on (0768) 66748.

QL disc

WHILE the world holds its breath waiting for the range of Quest hard and floppy drives for the QL, Micro Peripherals has brought out its own. The 3.5in. system has a capacity of 720K. Up to four drives can be hooked up to the QL.

An interface module costing £99 is needed in order to use the



system. The first disc unit costs £189 and the second £159. A jumper on the interface can be set so that drives are accessed instead of the QL's Microdrives. Alternatively, they can be addressed as FDK_1 and FDK_2 from software. A 10Mbyte hard disc is expected to be ready in April. More information on (0256) 473232.

(more news on next page)

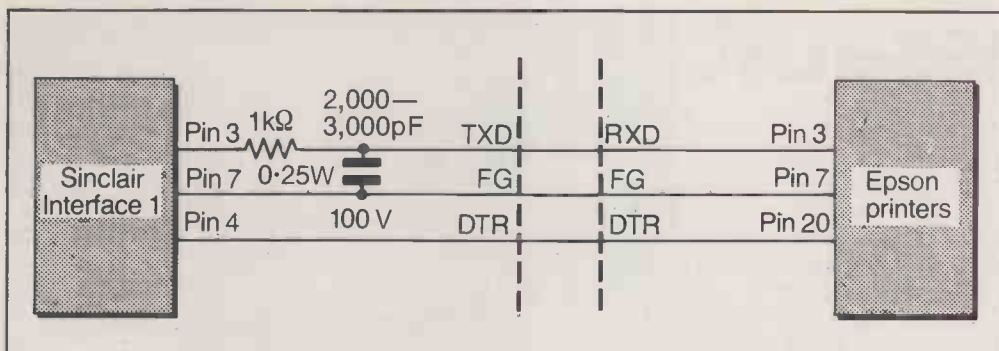

Interface 1

EPSON claims that the Sinclair Interface 1 may send out spikes on to the data line. This has caused the Epson printer to ignore any Escape codes which include CHR\$27. Epson claims that this occurs mainly on the P-40 thermal printer and that it has also been a problem on MX, RX and FX printers.

Epson has suggested a slight modification which should avoid the problem — see circuit diagram above. For more details contact Epson on 01-902 8892.

Fatten up your Macs

P&P MICRO distributors is offering to upgrade a 128K Macintosh to the 512K Fat Mac for £499.50 plus VAT. This is over £300 cheaper than the official Apple price.

Since any warranty remaining is invalidated by such

Model 15, comes with 256K RAM, a 15Mbyte Winchester and a 3.5in. floppy, together with one work station. The cost is £8,565. Up to 11 terminals and seven data-capture devices can be supported. For further details ring (03440) 773100.

Stride supermicros

THE STRIDE FAMILY of micros is produced by Sage, manufacturer of the Sage II and IV, which has now changed its name to Stride. The Stride 420 supports up to four users, the 440 up to 12 users and the 460 up to 22 users. The entry-level machine comes with a 68000 running at 12MHz, with 256K RAM and two 640K floppies. The price is about £3,400. The other two machines start at £6,000 and £9,000 respectively. Terminals cost around £500. More information can be obtained on 01-608 0818.

Spectrum disc drives

SPECTRUMS can be upgraded to something like a serious machine with new disc drives from Opus and Servicon. The Opus designs use 3.5in. discs with 256K unformatted capacity. A single drive unit costs £199.95 and will be sold only by Boots. Details on 01-701 8660.

The Servicon system uses a 2.8in. disc format with a capacity of 128K. The first disc-drive unit costs £129.95, the second £99.95. The interface contained in the first drive unit also provides an RS-423 socket and an RGB socket for colour monitor attachment. It is expected that the discs will

cost about £2 each. More information on (0594) 542021.

Touch-screen BBC

THE MICROVITEC Touchtech 510 adds a touch-screen capability to BBC Micros using metal cabinet Microvitec colour monitors. The cost of £210 includes all the relevant software.

Like the Hewlett-Packard 150 — reviewed in *Practical Computing* in May 1984 — the screen hood uses a grid of infrared beams to determine the point touched. The information is fed back via an RS-423 connection to the BBC Micro. Later versions will use the RS-232 serial communications protocols.

Also included in the price is a series of demonstration programs which give an idea of some of the potential applications. More details on (0274) 390011.

Mains power from 12V battery

THE RME-100 inverter box lets you run mains-powered transportables like the Apricot, Kaypro or Macintosh from the batteries of a car or van. Developer Rayman Electronics claims that in typical use you can run your system for 20 hours before the car batteries start giving out. Two conventional wall-type three-pin output sockets are provided, so you can also run a printer.

The RME-100 costs £195 plus VAT. More details from Rayman Electronics, 42 Charlesworth Street, Bolsover, Chesterfield, Derbyshire. Telephone: (0623) 748129.

Hardware shorts

- Sinclair has dropped the price of its Microdrive cartridges from £4.95 to £1.99.

- Alpha Disc Ltd has produced the XF floppy which offers Apricot and IBM PC MS-DOS formats on an 800K disc. The cost is £395. More on (0784) 35357.

- Purchasers of the Brother EP-44 and TC-600 personal telecom terminals can join Telecom Gold for the special price of £19.95. Details on 061-330 6531.

- Prestel Education is a new service on Prestel page 888 aimed at schools and colleges. School membership is £49 a quarter and gives access to all the Prestel microcomputing services, including Micronet 800. More on 01-583 9811.

- MSX-Net is a closed user group on Telecom Gold for MSX users. Membership is £10 per year for home users. Recent additions to the service include access to The Source and Blaise. Details on 01-788 3583.

- TCS has produced a breakout box that allows various types of RS-232 connectors to be dealt with. Price is £45. More information on (0273) 778161.

- The Essex Forth Microcard offers a single-chip computer with a 4K Forth kernel, an RS-232 interface and 16K RAM. Cost is £119. Details on (0206) 865089.

- Victor Technologies has surfaced under its own name in the U.K. Its address is Unit 1, The Valley Centre, High Wycombe, Buckinghamshire HP13 6EQ. Telephone: (0494) 450661.

- OE Ltd has produced a communications package for the Commodore 64, allowing Prestel and Telecom Gold connections. The cost is £64.95. More on (0768) 66748.

- A Sharp MZ-700 club is being formed in the U.K. Membership costs £18. More information on (0905) 58351.

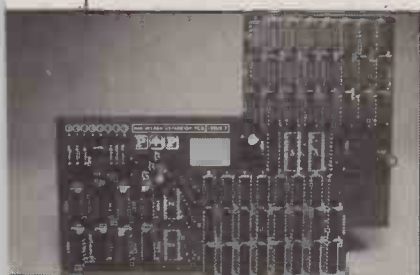

an upgrade, P&P is itself offering to match the warranty, and add on an extra month up to a maximum of 13 months for new machines. Details on (0902) 43913.

HP family grows

HP has introduced the HP-260 family aimed at the small business. The entry-level system,

Join Forces

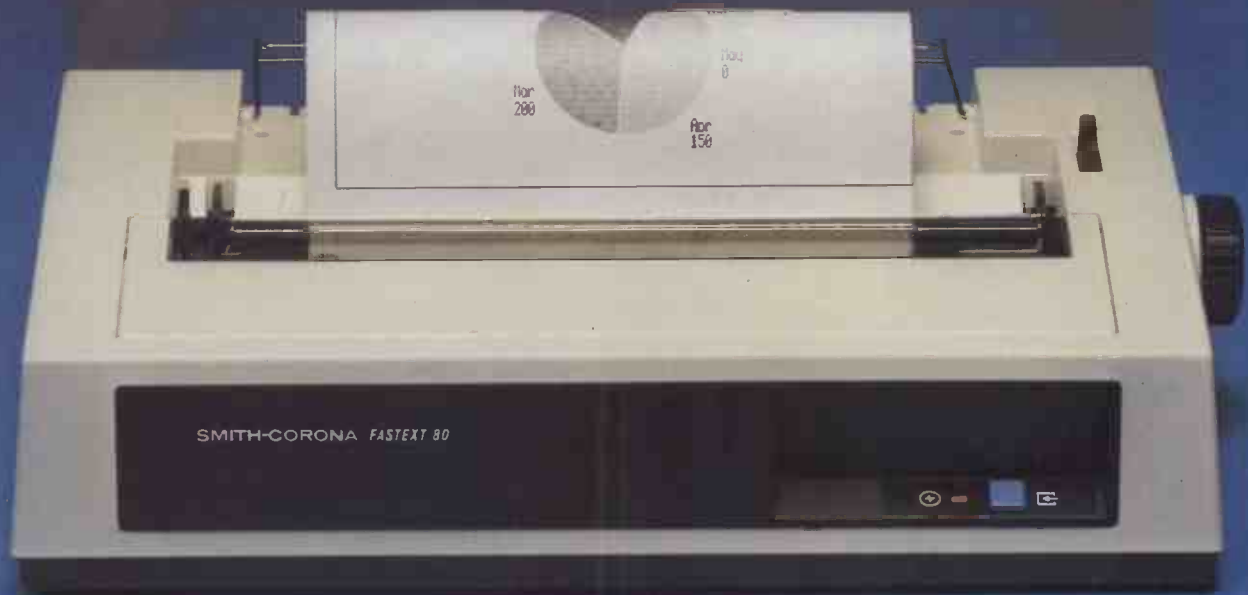

with Smith-Corona

Unleash the full potential of your computer with a printer from the Smith-Corona range. Race ahead with excellent hard copy—both text and graphics—produced by the latest dot matrix technology.

Take a closer look at the FasteXt 80. Compatible with Acorn, Apple, BBC B, Commodore 64 and most other micros and PCs, the FasteXt 80 is a fully featured printer that performs at 80 cps and boasts six pitches. Bi-directional and logic-seeking features plus a full line buffer minimise

printing time while simple paper handling is ensured with friction feed as standard, a tractor feed and roll holder being available. The FasteXt 80 is supplied with a Centronics parallel interface—a serial RS232C is an optional extra.

Link up with Smith-Corona now for the backing of their worldwide reputation and a nationwide dealer network. Make the first connection today—contact a distributor for a brochure and the name of your nearest Smith-Corona dealer.



SMITH CORONA

London-Central: Universal Micros Ltd., 65 Newbank Street, London W1P 3PG. Tel: 01-631 1959.
London-West: Millbank Computers Ltd., Millbank House, Amyand Park Road, Twickenham. Tel: 01-691 4691.
Home Counties: Simnett Computers Ltd., Unit 14, St. Georges Industrial Estate, 380, Richmond Road, Kingston-upon-Thames KT2 5PR. Tel: 01-541 1495. Wiltshire: Computercentre Ltd., Theatre Square, Swindon, Wiltshire SN4 4QN. Tel: 0793 694997. South Wales: Barbitan Ltd., 35-38 High Street, Bristol BS4 2AW. Tel: 0272-213928.
South West: CK Computer Supplies, Unit 5, Norside, Old Mixer Crescent, Weston-Super-Mare. Tel: 0934-418838.
Shropshire: Jentech Services Ltd., Smithfield Centre, Whitbury Street, Bridgnorth, Shrops. Tel: 07462-61498.
West Midlands: Daytron Ltd., Warwick House, Forge Lane, Minworth, Sutton Coldfield. Tel: 021-351 5959.
North East: Intac Data Systems Ltd., Frost House, Woodhouse Green, Thurgate, Rotherham. Tel: 0709-547177.
Manchester: Mancos Computer Services, Unit 3, Albany Road/Trading Estate, Manchester. Tel: 061-861 0757.
Merseyside: Rockcliff Microcomputers, 2 Rumford Street, Liverpool L2 8SZ. Tel: 051-227 2568.
Scotland: Chessbourne Ltd., 44 West Henderson Wynd, Dundee. Tel: 0382-29166.
Southern Ireland: TW Distributors Ltd., Frankfort, Dundrum, Dublin 4. Tel: 0001-728045.
Northern Ireland: Chessbourne Ltd., Hyde Park Industrial Estate, 17 Trench Road, Mullusk, Co. Antrim. Tel: 02313-43511.

Please send me:-

- further information on Smith-Corona printers
 the name of my nearest Smith-Corona dealer.

Name: _____

Address: _____

Postcode _____

Tel. No: _____

Have you got the drive to succeed in business?

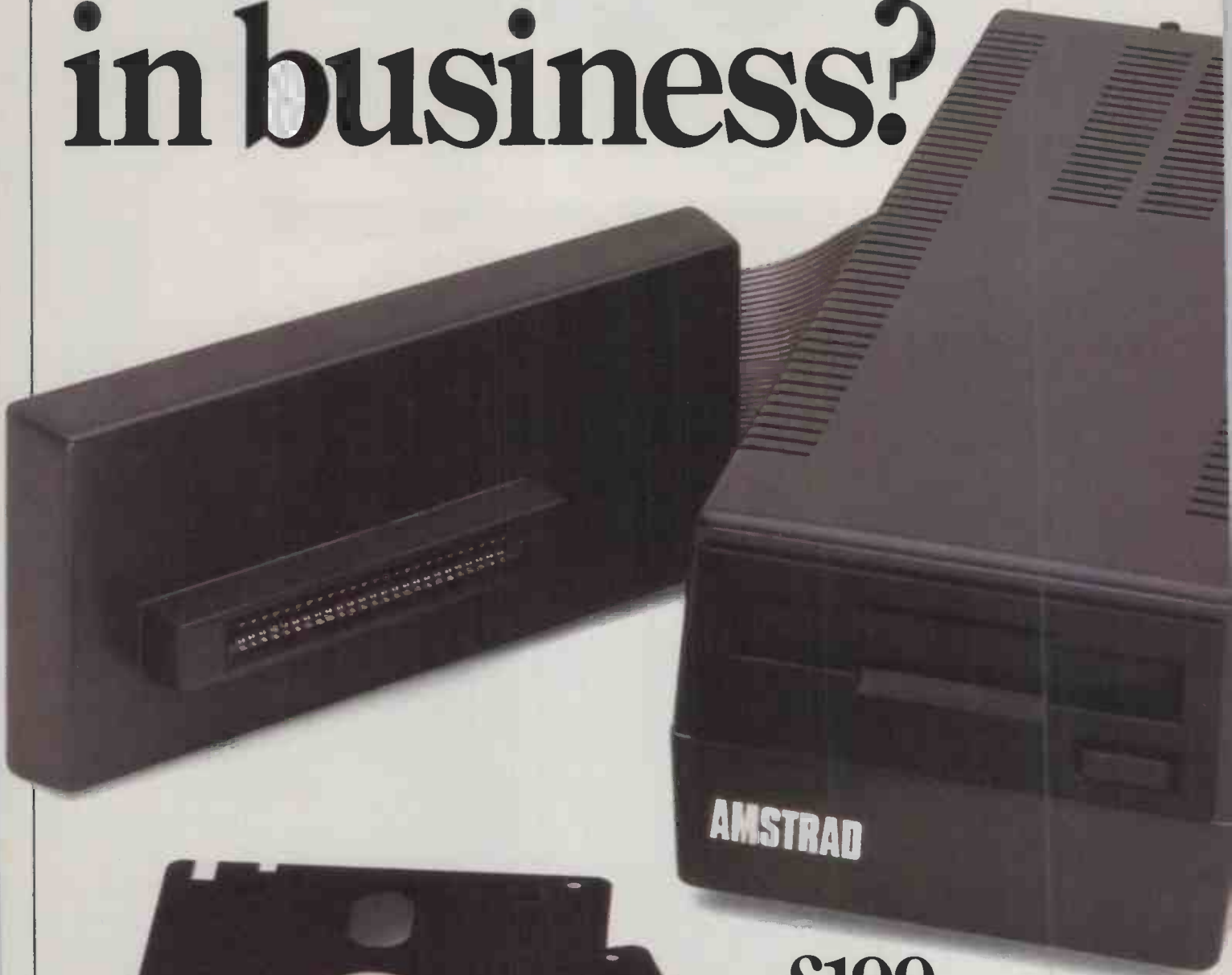

£199

DD1-1 disc drive (with CP/M* and DR. LOGO*) and interface.

£159

FD-1 additional disc drive.

Running any business successfully means first running it efficiently.

And no matter how business-like you think you are, you can't beat the power and convenience of a random access CP/M* disc system.

Now, with Amstrad's CPC 464 computer, you can enjoy all the advantages of a 3" disc drive complete with an integral power supply and plug-in interface controller.

Naturally, you can add a second drive (FD-1) to double the on-line storage capacity, speed up copying files and producing back-up discs.

But of course, simply plugging a disc drive into a computer won't get you very far.

That's why Amsoft have produced a disc based software range of over 30 programs with many more on the way.

AMSDOS and CP/M*

CP/M* is the standard disc operating system for 8-bit microcomputers.

We also supply a special version of DR. LOGO* for CPC 464 users.

Our disc drive system includes a number of extensions to BASIC in the AMSDOS operating system that allow the disc to use files originally created for cassette, and vice versa.

Software also takes care of the necessary file management so that CP/M* files can exist alongside these AMSDOS files.

Data files may even be shared between AMSDOS and CP/M*.

Word processing, data management, accounting, ledgers - you'll

£239

complete with green screen VDU (GT64) and FREE software pack worth over £100.

£349

complete with colour screen monitor (CTM640) and FREE software pack worth over £100.



CPC 464
complete
with
monitor
and
datacorder

find an AMSOFT program to suit whatever kind of business you want to do on your CPC 464.

There's even a range of programs that teach you professional business practice.

Incidentally, you can exchange your Amsoft cassettes for identical Amsoft disc software for a mere £4.95 per cassette (the cost of a blank disc).



Decision Maker

CPC 464.

Really gets down to business.

At the heart of it all, of course, is the incredible Amstrad CPC 464 computer.

The CPC 464 has a typewriter-style keyboard, large ENTRY key, sensibly positioned cursor keys, numeric keypad for fast data entry and a full 8-bit character set.

It provides high resolution graphics, 80 column text display, up to 8 text windows plus a graphics window and a palette of 27 colours.

There's also a built-in Centronics standard 7-bit parallel printer interface. So you can enjoy high performance word processing with the printer of your choice.

The CPC 464.

It does whatever you want it to do. But that, of course, is your business.



Optional 80 column dot matrix printer DMP-1. Operates at up to 50 characters per second.

AMSTRAD

ONE GREAT IDEA AFTER ANOTHER

BOOTS COMET Currys Dixons
Greens John Menzies RUMBELOWS spectrum
WHSMITH WIGFALLS AND OTHER COMPUTER STORES

*CP/M and DR. LOGO are Trade Marks of Digital Research

I'd like to know more about the businesslike CPC 464 complete computer system. Please send me literature right away.

NAME

ADDRESS

POSTCODE

To: Amstrad Consumer Electronics PLC, Brentwood House, 169 King's Road, Brentwood, Essex CM14 4EF.

PRICES CORRECT AT TIME OF GOING TO PRESS. NOT ALL STORES STOCK ALL PRODUCTS.

PC 8



Microscript

● Circle No. 120

TURNS BRAINBOXES INTO CHATTERBOXES

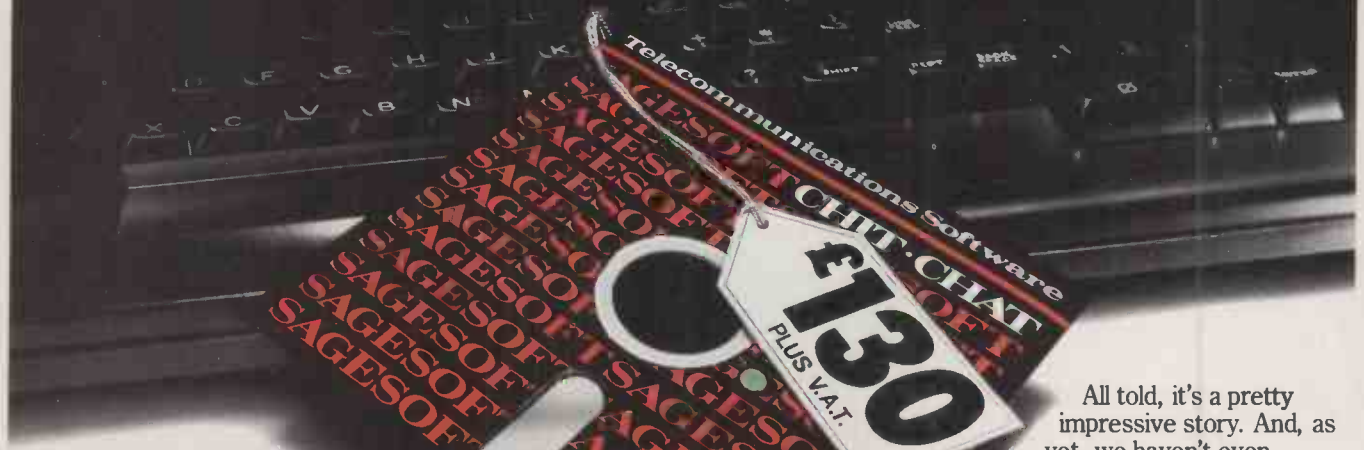

Computers are like people. They can learn from each other. But first they have to communicate. If your computer keeps itself to itself, why not introduce it to Sage Chit-Chat?

Chit-Chat is a versatile data communications program that can turn the most introverted computer into an outgoing conversationalist, in minutes.

By enabling your computer to communicate with other machines, Chit-Chat opens up a whole new range of possibilities for you. Data can easily be transferred, even between incompatible machines, either by cable if both are in the same building, or by telephone, using a modem. In this way, manual or automatic transfer of single or multi-files is possible between two machines, anywhere in the world.

Chit-Chat also gives you access to electronic mail systems, such as Telecom Gold and Easylink, which provide private and public mailbox facilities, plus worldwide telecommunications, telex and information management.

With Chit-Chat your computer can also engage in some very informative conversations with viewdata services like Prestel.

What's more, you'll be glad to know that you don't have to be a brainbox to turn your computer into a chatterbox. The Chit-Chat program is simple to understand, easy-to-learn and use, and suitable for use on a range of microcomputers.

All told, it's a pretty impressive story. And, as yet, we haven't even mentioned the price. £130 + V.A.T. That's all.

A small price to pay to give your computer a whole new social life. Currently available on IBM PC, Apricot, Wang PC, Sharp 5600, Epson PX8.

INCLUDES FREE SUBSCRIPTION TO **TELECOM GOLD**

Buy the Sage Chit-Chat program before March 31st, 1985, and you get a FREE subscription to Telecom Gold electronic mail service. Forget the standard registration fee of £100 - instead you pay only the minimum charge of £10 per month!

SAGE CHIT-CHAT

Please send me more details about Sage Chit-Chat and the address of my nearest dealer.

Name _____
 Position: _____
 Company: _____
 Address: _____
 Tel: _____

My Computer is a: _____
 I do not have a Computer

Sagesoft Limited, NEI House, Regent Centre, Newcastle upon Tyne NE3 3DS. Telephone: 091 284 7077. Telex: 53623 SAGESL G.

BETTER SAGE THAN SORRY PC4

Clever key utilities

THERE ARE now half a dozen fancy little utilities that enable you to customise your IBM keyboard and add macro facilities. Smartkey, Superkey, Quikey, Prokey and Keywap are examples.

The idea of the packages is that they enable you to redefine the keyboard and make some of the more unusual characters readily accessible. Also, a whole sequence of keystrokes can be assigned to a single key. This macro facility enables many repetitive tasks, whether in word processing, data entry or programming, to be made semi-automatic.

First in the field was Rossoft's Prokey. Version 2 arrived about 18 months ago, and version 3 late last year. It is available from Pete & Pam at £108 plus VAT.

Smartkey, from Software Research Technologies of Los Angeles, is the latest to reach the U.K. market, having been added to the Caxton Software range. It features a pop-up window so you can redefine keys while running other software. Caxton claims that over 30,000 characters can be assigned to a single key. Smart-

key costs £79 plus £3 post and packing, plus VAT.

Contact Caxton Software, 10-14 Bedford Street, London WC2E 9HE. Telephone: 01-379 6502.

Borland International, which produced the useful Sidekick program, has now launched a \$69.95 keyboard enhancer and macro programmer called Superkey in the U.S. Like Sidekick, it is RAM resident and claimed to be compatible with Prokey, but with added features including automatic recall, on-line help, cut and paste, and data encryption.

Automatic recall provides the facility to recall the last 20 commands, and to edit and reuse them. This is particularly valuable when working with PC-DOS. On-line help screens are provided via pull-down menus. Cut and paste means data can be taken from the screen, stored under a key, then moved into another application.

An extra function of the data-encryption module is to turn binary files into ASCII files. This enables them to be sent easily over the phone lines,

after which the recipient can use the encryption key to decode them.

Contact Borland International, 4113 Scotts Valley Drive, Scotts Valley, Ca 95066, U.S. Telephone: (U.S. area code 408) 438-8400.

The U.K. supplier is likely to be Coquin Software, 14 Goodwood Close, Morden, Surrey SM4 5AW. Telephone: (0524) 381423.

PC Automator is a new program that performs a similar task to Smartkey and Superkey, except it does this by providing a sort of enhancement to DOS. According to the distributor, the program "learns like a human operator by watching the keyboard and screen while the 'teacher' carries out the new procedures. It can be taught to make intelligent decisions, create help menus and ask and respond to questions, becoming in effect the 'perfect user'."

If it does all this it is probably a snip at £245 plus VAT. Contact Direct Technology, Grove House, 551 London Road, Isleworth, Middlesex TW7 4DS. Telephone: 01-847 1666.

IBM shorts

● Datatalk is a British communications package for the IBM PC and emulators. It uses colourful windows, offers help and has an autodial facility. The price of £135 plus VAT includes registration on Telecom Gold, One to One and Easylink. Phone Datasoft on (04605) 4809.

● Bubble memory is now available for the IBM PC in the form of the 512K XBIM



card. It is rugged, non-volatile and claimed to run eight times faster than a floppy disc. Phone Xcalibur on (0604) 21051/4.

● Options is a new business risk-analysis program from Sagesoft, which provides answers to What-If? questions transferred from a spreadsheet. It costs £145 plus VAT. Phone: 091-284 7077.

● IBM-style Basic is now available for the IBM PC. RM/Basic is the sort of language familiar from the System/23 and other large machines, not the Microsoft Basic which is standard on the PC. Phone Ryan-McFarland: (0992) 24981.

● Digital Research has announced DR Level II Cobol for PC-DOS. It meets full ANSI standards for high-level compilers, and costs £595. Phone (0635) 35304.

● Micro Status is a program to analyse traffic information from a PABX telephone switchboard. It costs £495, including a data-capture device. Contact Tiger Information Systems, Crown Court, Wimbourne, Dorset BH21 1LP.

● Olivetti has launched a 3274 emulator for the M-24. It comprises a plug-in board at £282, plus software: £403 for SNA, or £323 for BSC networks. Phone: 01-785 6666.

IBM results

TURNOVER rose 40 percent for IBM United Kingdom Holdings Ltd, according to provisional results for the year to December 1984. Sales in the

U.K. were up by 26 percent, exports by 58 percent, and pre-tax profits by 27 percent. Turnover was £2.35 billion, with after-tax profits of £200 million.

During 1984, IBM invested £149 million in the U.K., and

increased its staff by 1,380 to 17,506.

Domino

COMPSOFT, best known for its Delta database, has launched a £495 training and presentation aid called Domino. The package is for the fast production of colour-graphics screens for display, teaching, market research and all types of questionnaire and test. A library of popular shapes and images is supplied.

Domino will accept multiple choice, text, numeric or date responses, and transfer the results to Delta for analysis. The package will also generate reports.

Contact Comsoft plc, Comsoft Manor, Farncombe Hill, Godalming, Surrey GU7 2AR. Telephone: (04868) 25925.

(more news on page 25)



● LSI has developed a £199 plug-in board for its MS-DOS micro which detects IBM PC addresses and thus turns the Octopus into an IBM PC clone — except it is still claimed to run 50 percent faster than the IBM. The Octopus still has a Z-80 for running CP/M packages too. Phone: (04862) 23411.

BROTHER/PHILIPS FOR COMMUNICATION

COMMUNICATION BOX
For Brother Typewriters
(including 16K buffer)



£249 + VAT

BROTHER/PHILIPS CROWN RANIER COMMUNICATIONS BUFFERED INTERFACE

Access Telecom Gold or similar telecommunications. Simply plug into back of Brother CE51/60/70 or with cable kit for CE50 EM80/100/200. Technical Information: The Crown Ranier Brother/Philips interface is an intelligent logic seeking send and receive device, offering a full set of escape sequences and ASCII character set (0 to 7F). This unit has been purpose designed for Brother Typewriters.

CROWN RANIER

Main Distributors: Crown Sales 56-58 South Street
Tel: Eastbourne 639983/20496 Eastbourne, Sussex
Trade enquiries invited

● Circle No. 170

BROTHER/PHILIPS PLUS

VIEWTYPER

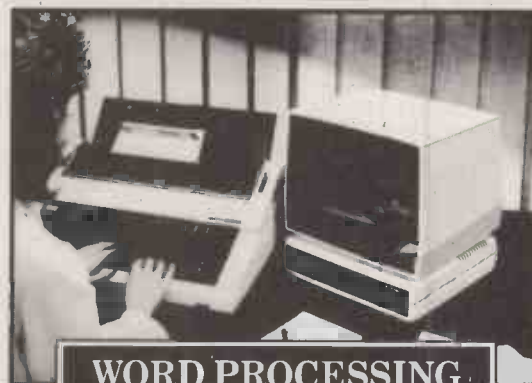

WORD PROCESSING & COMMUNICATIONS

Only the Viewtyper offers a cost effective solution for word processing plus communication via telephone or cable. The viewtyper with its complete word processing programme, 64K memory, 160K disk storage, optional twin disk system and simplicity of use adds a new dimension to your EM1/2* CE51/60/70 EM80/85/100/200. The total price is only £1575.00 + £236.25 VAT.

Telecom Gold and background print facility now available. *Requires interface. Word processing only.

— JUST ADD A BROTHER OR
PHILIPS

PRINTER REPAIRS AND SERVICE TEL: 061-428 2014

- * DOT-MATRIX & DAISYWHEEL
- * COLLECTION & DELIVERY SERVICE
- * FAST TURNAROUND
- * 3 MONTH WARRANTY ON WORK
- * FIXED RATES — FIRM QUOTES
- * WORKSHOP CONTRACTS AVAILABLE

A+G COMPUTERWARE
PO BOX 34
CHEADLE
CHESHIRE SK8 4PT

● Circle No. 155

SANYO MBC 550 SERIES

COMPUTERS, SOFTWARE, PERIPHERALS, ACCESSORIES

COMPUTERS	PERIPHERALS
MBC550 1*160K drive + over £400 free s/w.....£749.00	2*160K drives.....£299.00
MBC555 2*160K drives + over £1000 free s/w.....£999.00	2*360K drives.....£450.00
MBC550-1 1*360K drive + over £400 free s/w.....£990.00	2*720K drives.....£600.00
MBC555-2 2*360K drives + over £1000 free s/w.....£1390.00	10MB Winchester.....£1500.00
MBC55S 2*720K drives + over £1000 free s/w.....£1550.00	15MB Winchester.....£1866.00
MBC775 2*360K drives, IBM PC compatible portable with 9" colour screen etc.....£2150.00	20MB Winchester.....£1956.00
	40MB Winchester.....£3177.00
	20MB Tapestreamer.....£2155.00
	40MB Tapestreamer.....£2299.00
	20/20 Double Box.....£4587.00
	40/40 Double Box.....£6108.00
	Kaga 12" RGB HR.....£285.00
	Kaga 12" TGB SR.....£399.00
COMPLETE BUSINESS SYSTEM	
SANYO MBC555 + Sage accounts package + CRT36 monitor and MT-80 printer and cable and blank disks.....£1550	
SOFTWARE	ACCESSORIES
Easywriter.....£233.00	RS232 Serial.....£50.00
Superwriter.....£203.00	64K RAM set.....£90.00
SuperCalc 3.....£295.00	128K RAM card.....£399.00
dBase II.....£365.00	256K RAM card.....£499.00
Friday.....£190.00	384K RAM card.....£599.00
EASY junior.....£395.00	10 SSDD Dysan discs.....£23.00
MS-DOS 2.11.....£45.00	10 DDDD Dysan discs.....£35.00

Note: All prices are exclusive of VAT

We offer a FREE one year maintenance contract on all Sanyo computers sold in Bedfordshire and surrounding counties. For further information on any of our products, please ask us to send you full information.

TEL: (0234) 213645

ZEDEM COMPUTERS LIMITED
2 KIMBOLTON ROAD, BEDFORD

● Circle No. 175

Consumables!

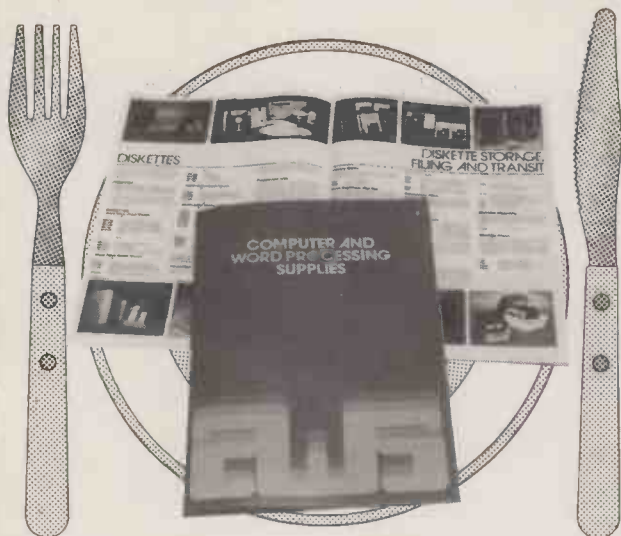

Don't make a meal of ordering your computer supplies phone

01 541 1188
For your free catalogue



AWS Computer Supplies, 57 Surbiton Road, Kingston-upon-Thames, Surrey KT1 2HG

● Circle No. 115

C Compilers

DeSmet C PC/MS-DOS.....	£139.00
Lattice C PC/MS-DOS.....	£490.00
C86 & optimiser PC/MS-DOS.....	£385.00
Microsoft C PC/MS-DOS.....	£460.00
Aztec C86 PC/MS-DOS.....	£235.00
Aztec C II App-DOS.....	£195.00
Aztec C II CP/M-80.....	£195.00
C/80 Software Toolworks CP/M-80.....	£ 50.00
C/80 Mathpak — floats and longs CP/M-80.....	£ 30.00
BDS C CP/M-80.....	£135.00
ECC-C for Z80 Code CP/M-80.....	£195.00
VENIX-86 full Unix for IBM PC-XT and PC-AT.....	from £850.00

and many look-alikes

LISP Interpreters

LISP-80 Software Toolworks CP/M-80 & MS/PC-DOS.....	£ 50.00
MuLISP/MuSTAR CP/M & MS/PC-DOS.....	from £175.00
MuMATH CP/M & PC/MS-DOS.....	from £215.00
IQ LISP PC-DOS.....	£160.00

FORTH-83 from Laboratory Microsystems

Z80 Forth CP/M-80.....	£ 95.00
PC-FORTH PC-DOS.....	£ 95.00
8086-FORTH CP/M & MS-DOS.....	£ 95.00
PC FORTH + , 8086 FORTH + (32 bit address).....	£235.00
Floating point extensions.....	£ 89.00

Programmers Editors

SEE Editor for IBM-PC and Apricot.....	£ 50.00
EC Editor (windows and DOS calls) PC-DOS.....	£125.00
PMATE IBM-PC and Apricot.....	£225.00
FirstTime C (with syntax checker).....	£295.00
FirstTime Pascal (with syntax checker).....	£245.00

Pascal Compilers.....	£ call
Fortran Compilers.....	£ call
Assemblers and cross-assemblers.....	£ call

Uniform — Read & Write Many formats — for Epson Qx-10..... £ 75.00
Osborne, Kaypro, Xerox 820 and others

HSC 16 bit Co-Processors for Z80 CP/M systems

- choice of 8086 or 6800
- 6 MHz clock
- MS-DOS, CP/M-86 and CP/M-68K
- 256Kb to 1.25 Mb memory
- memory available as RAM disk
- fit most Z80 systems
- simple to install, simple to use. Prices from £675.00

Prices are exclusive of VAT and postage

System Science

6-7 West Smithfield, London EC1A 9JX
Tel: 01-248 0962

● Circle No. 168

DISKS DISKS DISKS

BEST PRICES - TOP QUALITY - FAST DELIVERY

***** PRICE PROMISE *****
We will better any genuine delivered price advertised in the current issue of PC for Boxes of Disks shown in the list below. Please Telephone for price.
***** QUALITY FACTORY SEALED DISKS NORMALLY SAME DAY DESPATCH

5.25" DISKS

BOXES OF 10 DISKS		Prices per Box (£)		
		1-4	5-9	10-49
DYSAN	104/1D HR S/side 0 Dens 48tpi 40Tr	16.50	15.90	15.30
	104/2D HR D/side 0 Dens 48tpi 40Tr	24.00	23.25	22.50
	204/1D S/side Q Dens 96tpi 80Tr	24.00	23.25	22.50
	204/2D O/side Q Dens 96tpi 80Tr	29.00	28.25	27.50

VERBATIM DATALIFE (5 Year Warranty)	MD525-01HR S/side S or D Dens 48tpi 40Tr	14.95	14.70	14.20
	MD550-01HR D/side S or D Dens 48tpi 40Tr	19.20	18.45	17.70
	MD577-01HR S/side Q Dens 96tpi 80Tr	19.20	18.45	17.70
	MD557-01HR D/side Q Dens 96tpi 80Tr	25.20	24.95	24.00

10 or 16 hard sectors at same price. Add £1.20 for library box.

VERBATIM VEREX	MD200-01HR S/side S Dens 48tpi 40Tr	13.75	13.25	12.75
-----------------------	-------------------------------------	-------	-------	-------

MEMOREX (5 year warranty)	3431 HR S/side S Dens 48tpi 40Tr	Please Telephone for MOST COMPETITIVE Prices		
	3481 HR S/side D Dens 48tpi 40Tr			
	3491 HR D/side D Dens 48tpi 40Tr			
	3504 HR S/side Q Dens 96tpi 80Tr			
	3501 HR D/side Q Dens 96tpi 80Tr			

BASF	10 S/side D Dens 48tpi 40Tr	10.99	10.50	10.00
-------------	-----------------------------	-------	-------	-------

BASF (Qualimetric) ** FREE Library Box with every 10 Disks **	1X HR S/side S Dens 48tpi 40Tr	14.10	13.70	13.30
	1D HR S/side D Dens 48tpi 40Tr	14.70	14.20	13.70
	2D HR D/side D Dens 48tpi 40Tr	18.65	17.90	16.65
	10/96 HR S/side Q Dens 96tpi 80Tr	19.30	18.55	17.30
	20/96 HR D/side Q Dens 96tpi 80Tr	22.00	21.25	20.50

HR denotes Disks with Reinforced Hub Rings.

ACCESSORIES	HCK5 Head Clean Kit with Fluid	14.90	14.50	14.00
	LC5 5.25 EGLY Library case	1.90	1.80	1.70
	LB40-5 ABA Lockable Box 40 Cap inc Disk Pen	13.50	13.00	12.50
	LB50-5 ABA Lockable Box 50 Cap inc Disk Pen	14.75	14.25	13.75
	LB90-5 ABA Lockable Box 90 Cap inc Disk Pen	16.50	16.00	15.50
	VCK-5 Verbatim 5" Head clean kit	6.40	6.20	6.00
	VCD-5 Verbatim 5" H/c disks (per 10)	12.50	12.30	12.10
	DPEN BEROL Quality disk pens (per 12)	5.25	5.00	4.75
	DL-5 Disk Labels 100 (5 colours)	4.50	4.25	4.00
	DM-5 Disk Mailers 4 disk cap (per 100)	21.00	19.50	18.50

SONY	3.5" DISKS			
	0M-D3440 S/side D Dens 80Tr	33.00	32.25	31.50
	0M-D4440 O/side D Dens 80Tr	42.50	41.75	41.00

VERBATIM	M 350 S/side D Dens 80Tr	34.00	33.25	32.50
-----------------	--------------------------	-------	-------	-------

BASF (Qualimetric)	FD3.5 S/side 80Tr (Boxed in 5's)	17.00	16.50	16.00
---------------------------	----------------------------------	-------	-------	-------

ACCESSORIES	S10-3.5 SEE-10 Library Box	2.30	2.15	2.00
	LB60-3.5 ABA Lockable Box 60 Cap inc Disk Pen	15.50	15.00	14.50

8" DISKS

VERBATIM DATALIFE (Five Year Warranty)	FD34-9000 S/side S/Den	19.50	18.50	17.50
	FD34-8000 S/side D Den	19.50	18.50	17.50
	DD34-4001 D/side D Den	23.00	22.00	21.00

MEMOREX (Five Year Warranty)	15 S/side S Dens	Please Telephone for MOST COMPETITIVE Prices		
	1D S/side D Dens			
	2D D/side D Dens			

BASF (Qualimetric)	1X S/side S Dens	16.00	15.00	14.00
	1D S/side D Dens	19.00	18.00	17.00
	2D D/side D Dens	22.00	21.00	20.00

ACCESSORIES	LB40-B ABA Lockable Box 40 Cap inc Disk Pen	16.50	16.00	15.50
	VCK-8 Verbatim 8" Head clean kit	6.40	6.20	6.00
	VCD-8 Verbatim 8" H/c disks (per 10)	12.50	12.30	12.10

PAPER-LABELS-CASSETTES

	PAP1 9.5"x11" 60gsm 2000 sheets	11.00	10.50	10.00
	PAP3 A4 80gsm Bond 2000 Sheets	24.50	23.50	22.50
	PAP4 A4 90gsm Bond 1000 Sheets	13.50	12.75	11.50
	LAB1 89mmX36mm 2 on web 8000 labels	23.00	22.00	21.00
	CI2 CI2 Quality Screw Assembly(10)	4.50	4.30	4.10

RIBBONS - PRINTWHEELS - PRINTERS - SOFTWARE

Telephone or write for very competitive prices on a large range of goods.

Please contact us for Quantity Discounts (50+ boxes) and Trade Accounts.

Official orders accepted from Government or Educational Establishments.

Description	Quantity	Amount

Postage/Packaging (1IK)	5.25/3.5 Disks, HCK5	£1 /Box* (75p 5+, £5 Max)	Post/Pack
	8" Disks, VCD8, CI2	£1.3/Box* (95p 5+, £5 Max)	Total exc VAT
	LC5, DL5, VCK5/8, VCD5, DPEN	50p/each (35p 5+, £5 Max)	Vat @ 15%
	Lockable Box, Labels	£2.5/Box (£2 2+, £5 Max)	Total inc VAT
	Paper, DM5	£1.5/Box (£2 3+, £15 Max)	

* Add 30p for First Class Post

Name _____ Tel.No. _____

Address _____

Post Code _____

Access/Barclaycard/Cheque No. _____

TELEPHONE ORDERS ANYTIME --- WE DO THE REST
34 CANNONBURY AVENUE PINNER MIDDX HA5 1TS
01 868 9548



Pinner Wordpro



● Circle No. 157

<p>Tandata SMART MODEM MICRO PACK For use with the IBM PC</p>
<p>Tandata SMART MODEM MICRO PACK For use with the ICL Personal Computer</p>
<p>Tandata SMART MODEM MICRO PACK For use with the Columbia PC</p>
<p>Tandata SMART MODEM MICRO PACK For use with the Superbrain II</p>
<p>Tandata SMART MODEM MICRO PACK For use with the Epson QX-10</p>
<p>Tandata SMART MODEM MICRO PACK For use with the ACT SIRIUS</p>
<p>Tandata SMART MODEM MICRO PACK For use with the ACT APRICOT</p>
<p>Tandata SMART MODEM MICRO PACK For use with the Philips P2000C</p>
<p>Tandata SMART MODEM MICRO PACK For use with the Apple II, IIe and IIc</p>

Plus Televideo, Cifer, Research Machines 380Z, Amstrad, BBC Model B, Commodore 64, Commodore Pet, VIC 20 ... and other MS DOS, CP/M86 and CP/M micros.

Complete Communications

AUTO DIAL MODEMS

V23 1200/75 from £99.00 + VAT

V21/23 1200/75 & 300/300 from £173.00 + VAT

PLUS

MICROPACKS FOR YOUR MICRO

Matched software for Prestel, private viewdata and general communications, complete with user manual, the correct cable and graphics chip if required.

Also available for many micros, the new Tandata "View-Tex" - the most powerful communications software yet!

Tandata

Tandata Marketing Limited,
Albert Road North, Malvern, Worcs. WR14 2TL.
Telephone: 06845 68421 Telex: 337617 Tandat G
Prestel * 799 # Telecom Gold TAN 001

Please send me full details of your smart modems and micropacks.

Name _____

Address _____

Micro make and model _____

Send to Tandata Marketing Limited,
Albert Road North, Malvern,
Worcs. WR14 2TL.

PC4

APPROVED
for use with
telecommunication systems
run by British
Telecommunications
in accordance with the
conditions in the
instructions for use

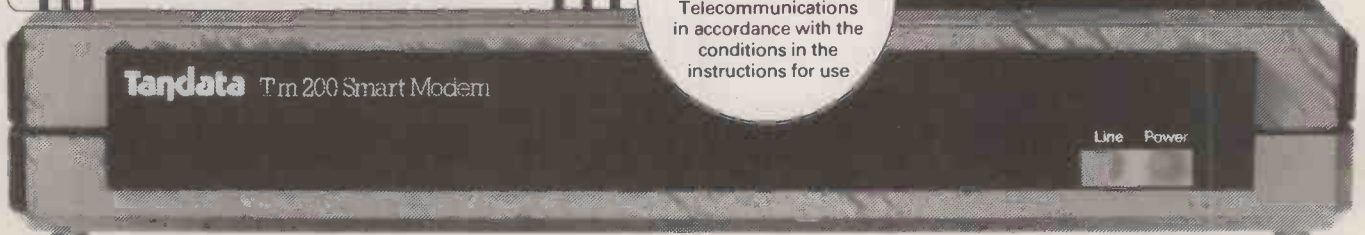



Amos/PC

ALPHA MICRO has expanded its line of multi-user systems by putting Amos — Alpha Micro operating system — on to the IBM PC/XT and look-alikes.

The new £2,400 package consists of an AM-170 board with a Motorola 68000 CPU and 128K of RAM. Then by loading the copy of Amos supplied, the PC is turned into a three-user multi-tasking system.

Advantages of the system are that it is available now via 75 Alpha Micro dealers. Also, Alpha Micro has been selling multi-user systems since 1977 so there is already applications software available.

A further product is Alpha Micros ELS twin-processor micro. This is an Alpha Micro system with 10Mbyte hard disc, 360K floppy and two processors. There is a 68000 with 128K of RAM to provide a three-user Amos system. There is an Intel 8088 with 256K of RAM to provide a single-user MS-DOS system.

At the moment MS-DOS and Amos cannot be run at the same time. However, text files can be interchanged between the two. ELS users can later upgrade to, say, 40-user Alpha Micro systems.

Contact: Alpha Micro-systems (G.B.) Ltd, Berkshire House, 56 Herschel Street, Slough, Berkshire SL1 1PY. Telephone: (0753) 821922.

IBM goes for graphics

IBM HAS announced a series of products for people who require high-resolution graphics, including scientists and engineers as well as graphic designers. The main products are a graphics monitor and a graphics-controller card, which includes an Intel 8088 chip.

The system is able to display 256 colours from a palette of 4,096, with a resolution of 640 by 480 pixels. It is also able to rotate, translate and scale drawings. The display costs £1,226 and the controller card £2,829.

Other products in the range are a development toolkit £379, graphical file system £169, graphical kernel system £278, plotting system £211, and

graphics terminal emulator £278, which emulates the Tektronix 410X and Lear Siegler terminals.

Further accessories are also available for controlling laboratory processes. IBM has also launched Ryan McFarland's ANSI-77 standard Professional Fortran at £555.

Add VAT to all prices given. Contact your local IBM PC dealer for details.

Smartwork

IF YOU design printed circuit boards up to 10in. by 16in. Smartwork is a specialised colour-graphics program that lets you do it on an IBM PC. If you want to join two conductors, you just mark them and the program draws the shortest line that does not cross other conductors on the same side of the board. The program also enforces minimum line spacings and trace width. On completion the artwork can be printed out on a dot-matrix printer or pen-and-ink plotter.

Smartwork was designed by the Wintek Corporation in Lafayette, and costs £895 in the U.K. A demonstration disc is available for £10. A complete system including the computer, training and maintenance costs around £4,000. All prices exclude VAT.

Contact Coquin Software, 14 Goodwood Close, Morden, Surrey SM4 5AW. Telephone: 01-646 3493.

Persona

A NEW company has been formed to distribute IBM PC

add-ons, and the first offerings available are PC Supercharger, G/Net, Comgraphics, Piggyplus and Comtronics cards.

PC Supercharger is a board that has been developed by Gateway Communications in Irvine, California. It has an 80186 chip running at 7.16MHz and from 128K to 1Mbyte of RAM, which is claimed to make an IBM PC run up to 10 times faster.

G/Net is a local area network, also developed by Gateway. It can connect up to 255 IBM PCs or compatibles using coaxial cables over a distance of up to 7,000 feet. There are SNA and X-25 gateways also available.

The remaining products have been developed by Comway Electronics, a firm based in Toronto, Canada. Comgraphics is an IBM and Hercules-compatible card for running graphics on the green monitor with a 720- by 348-pixel resolution. Comtronics is an enhanced IBM colour-compatible display adaptor. It offers four colours with a resolution of 640 by 200 pixels, or 16 colours with 320 by 200 resolution.

Both cards have a parallel port, and can handle extra memory via the Piggyplus board. This expands memory to 448K and includes a RAM disc, print spooler, clock/calendar with battery backup and a games port. The Piggyplus board is also available separately if you happen to have a spare expansion slot.

For further information contact Persona (U.K.) Ltd, 38 High Street, Kingston upon Thames, Surrey KT1 1HL. Telephone: 01-541 4343. 

The Next Two Pages Could Change Your Life



At Amplex we've created two new terminals which offer advanced emulations, editing and ergonomics at prices our competitors just can't believe. (Some get fairly near our features but nowhere near our prices).



Others can match our prices but their features are limited. How about the Amplex 210? You can see it looks good. But can you also see the way its 14" amber screen tilts and swivels into the most comfortable position?



It has a detachable low-profile DIN standard Selectric-style keyboard whose slope you can adjust. It is beautifully styled and superbly engineered inside and out (otherwise it wouldn't carry the Amplex name).



It has 7 resident national character sets, 14 program function keys and an 80-character status line. With line graphics and a bidirectional printer port as standard. So too are the local editing and block mode transfer capacities



to speed up work flow. But here's where our competitors wonder what's hit them. The Amplex 210 gives you 16 resident emulations at the touch of a key. And all for the price of an ordinary terminal.

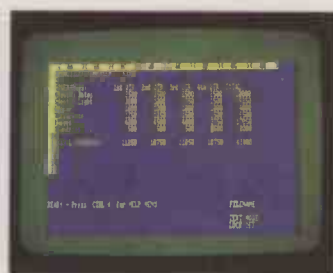

Amstrad disc software

AMSTRAD'S software arm, Amsoft, has released a large number of disc-based software packages for the Amstrad CPC-464. Games, home-education programs and several serious packages suitable for business use are among the titles on offer. At the same time Amsoft has released details of a forthcoming full accounting suite for the CPC-464, which up to now has been regarded as a home enthusiast's machine.

The change in emphasis follows the introduction of Amstrad's add-on disc drive for the CPC-464, which is now being shipped in quantity. Price of the 3in. Hitachi-based disc unit is £199 including VAT, which includes DR Logo and CP/M 2.2.

The new software releases include a word processor, Microscript, and a database, Micropen, which each cost £49 including VAT; either package can accept data transferred from the other. Amsoft is offering two disc-based spreadsheets: a full-feature one with built-in financial functions, called Microspread, price £49, and the simpler Mastercalc at £29.95.

Several titles from Triptych Publishing's Brainpower business-education range are now available on disc. Entrepreneur, Project Planner and Decision Maker are priced at £29.95. Star Watcher, a program which teaches you the constellations, costs £23.95.

Programmers are not forgotten, with Hisoft Pascal priced at £39.95, and Screen Designer, a graphics programming utility, at £18.95. Games on disc are generally priced at £12.95 and include Code Name Mat, Durrell's Harrier Attack, and Chess from Micro-Gen.

Amsoft's accounting suite is due to arrive in April. The set of five linked accounting packages from Quest International are basically the same as the well-known Padmede programs. The stock control, invoicing and sales ledger modules are closely integrated and sold as a set, price £99 including VAT. The purchase and nominal ledgers will link in to the rest of the suite, but are available separately at £33 each.

Contact Amsoft, Brentwood House, 169 King's Road, Brentwood, Essex CM14 4EF. Telephone: (0277) 230222.

Free Commodore software

THE FOLKLIFE TERMINAL CLUB is an international Commodore user group based in the United States, which has an archive of over 6,000 public-domain programs. The Club has just issued a new catalogue and is making its software library available to other Commodore users for a charge of \$15 per disc to cover media mailing.

The programs range from educational, scientific, and utility software to business

applications and games. The catalogue disc listing the available programs is probably the first one to order.

The Club supports Commodore 64, Plus-4, Vic and most Pet configurations. The \$15 per disc is probably best paid by a Post Office international money order.

Contact Folklife Terminal Club, Box 555-SB, Co-op City Station, Bronx, NY 10475, U.S.A.

Software shorts

● Optionware is a range of nearly 60 pre-programmed Lotus 1-2-3 applications templates. Subjects covered include financial statistics, budgeting, asset management and personnel. Any individual Optionware module costs £75, while a set of five in one subject area costs £299. Contact First Software on (0256) 463344.

● Mac-BCPL is the latest language available on the Macintosh. BCPL is a compiled high-level language particularly suited for developing system software and other high-performance programs. The Mac version costs £145 plus VAT. Details from Top Express Ltd. Telephone: (0223) 355427.

● Audiogenic is offering Commodore 64 users a demo version of its Micro Swift cassette-based spreadsheet program for 50p. The full working version costs £19.95. Contact Audiogenic on (0734) 664646.

● Index-Aid consists of two programs which assist in the compilation of indexes. The first is the compilation program proper, the second gives you control over the form of the final printed index. Available for the Osborne 1 or the IBM PC. Index-Aid costs £30. Details from ALLM Books, 21 Beechcroft Road, Bushey, Hertfordshire WD2 2JU.



You can emulate the Tele Video 910, 910+, 912, 920 or 925* And the Lear Siegler ADM3, ADM3A, 3A+ or ADM5*

*TeleVideo, Lear Siegler, Esprit and Qume are trademarks of TeleVideo Systems Inc, Lear Siegler Inc, Esprit Systems Inc, and Qume Corporation respectively.
†ADDS, Regent and Viewpoint are trademarks of Applied Digital Data Systems Inc



You can emulate the Hazeltine Esprit 1400, 1410 or 1500* the Qume's QVT 102* and the ADDS Regent 20, 25 and Viewpoint†



You want something even better? Try the Ampex 230. It's like the 210 with different resident emulations. But what makes the 230 special is an extra row of 16 programmable keys which effectively doubles its emulations to 32.



It has a 132-column display, a 400 byte double-page memory, 9 resident national character sets, and many quality features you only find on desperately expensive machines. The Ampex 230 has everything. It lets you do everything.



There's more. In OEM quantities we'll customise the appearance and programming of either terminal to any specification.

Mac Pascal compiler

TDI has launched a compiled Pascal for the Macintosh. Macadvantage is a UCSD Pascal compiler which supports the full range of features contained in the Mac's toolbox ROM, including pull-down menus, multiple windows and mouse routines.

The significance of the product for software developers is that it allows them to write Mac applications programs which will run on any Macintosh. End-users will not need a run-time Pascal system.

Apple itself offers two versions of Pascal, but there are drawbacks to both. Mac Pascal is interpreted, so only people who have a copy themselves can run programs written in it. Apple's Pascal compiler only runs on the Lisa; you can use it to develop software for the Macintosh, but you need to have both a Mac and a Lisa to do it. The price for Macadvantage is £295 plus VAT. Details from TDI Ltd. Telephone: (0272) 742796.

Apple II indexer

BOOKENDS for the Apple IIe and IIc lets you create an index of books or articles with an abstract of up to 720 characters per book. You can then search by author, title, keyword or any phrase contained in the

abstract. Bookends costs £105.95 plus VAT. Details from P&P on (0706) 217744.

Samna Word III

WORD III is the latest and most powerful word processor in the Samna family. Running on the IBM PC and other popular MS-DOS machines, Word III is a general-purpose word processor, but with special features making it suitable for technical and scientific documents and writing in foreign languages.

Word III comes with eight

alternative keyboards pre-defined in software. You simply select the French, German or Spanish keyboard, for example, and the appropriate symbols and accents are generated as you hit the keys. A scientific keyboard with Greek and mathematical characters is included among the eight.

The package also has an 80,000-word spelling checker built-in, and links to Samna's financial-modelling and text-retrieval packages. The only problem is the price: £503 plus VAT.

Contact Softsel Computer Products, Softsel House, Central Way, Feltham, Middlesex TW14 0XQ. Telephone: 01-844 2040.



McPic is the latest in a growing number of picture libraries for the Macintosh. McPic comes on two discs, each costing £49.95 plus VAT and each holding about 130 images. You paste copies of the picture into documents created with Macwrite, the Macintosh word processor, or most other Mac programs. Contact P&P on Rossendale (0706) 217744.

QL quickies

● Sinclair Research has released version 2.0 of the word-processing, spread-



sheet, database and graphics application software bundled with the QL. The new versions are claimed to work 20 to 30 percent quicker and load twice as fast. Because the code is now more

compact, more space is left for the user's files. The version 2.0 software is included in the price of all new QLs, currently £399 including VAT. Existing QL owners who have joined Sinclair's QL User Bureau should be receiving the upgrade through the post without charge.

● Another 68000 assembler has joined the list competing for the allegiance of keen QL Programmers. The latest offering is distributed by Sinclair itself and written by GST computers. The assembler comes with a full-screen editor and costs £39.95 including VAT. Competing assemblers are available from Bristol-based Metacomco and Adder Publishing of Cambridge. Contact Sinclair Research

Ltd, Camberley, Surrey GU15 3BR. Telephone: (0276) 686100.

● Prolog is on the way for the QL, although actual delivery of the product is still several months away. Expert Systems International Ltd has signed a contract with Sinclair Research to produce a version of the artificial intelligence language for the 68008-based machine. QL Prolog is to cost under £100, while the basic QL costs £400 at the moment. These prices will make the QL/Prolog combination the cheapest way to get hold of a working Prolog system, and should guarantee plenty of interest, particularly among the university AI fraternity. Contact Sinclair Research for details.



There's more. We produce both terminals with amber screens as standard. But unlike others, you can have green if you prefer at no extra cost.



There's more. Every terminal has a six-month warranty. And you have our worldwide service network to call on. Anywhere. Any time.



Meanwhile, everyone's still wondering how Ampex can offer such extraordinary features at such ordinary prices.



Would you like to see the 210 and 230 in action? Would you like to play with them? Without obligation? Call Julie McClafferty on Reading (0734) 875200.

"The 210 and 230 terminals are the first in a brand new family of high-quality low-cost Ampex computer products. Keep watching!"

AMPEX

Ampex Corporation
One of The Signal Companies
Acre Road, Reading, Berks.
Telex 847611

Why can't all our printers be like the JUKI 6100?

Because every business is different. Not everyone, for instance, needs the full sophistication of our remarkable 6100. (Though judging from the fact that it's one of the best-selling printers in the UK, quite a few people do). And not everyone has an IBM* computer (though for those that have we've just introduced the brand-new, IBM* graphic printer compatible 6100-I). No, not for us the 'take it or leave it' approach,

but a sensible, sensitive appreciation of individual needs and requirements. So whatever you want from your printer, you'll find a JUKI that's just right for you.

But just because you're concentrating on their differences, don't overlook the important fact that two things, at least, never change. Quality and value, for instance. In these respects, all JUKI printers are the same.

*IBM is a trade-mark of IBM Corporation.

JUKI 6100: one of the best-selling letter quality daisywheel printers in the UK. Graphic mode and full word processing support. £399.-

JUKI 2200: fully portable daisywheel printer with 2k buffer memory and full word processing support. Ideal for use at home. £269.-

JUKI 6300: high speed (40 cps) daisywheel printer with 3k buffer memory and full word processing support. £799.-

JUKI 6000: letter quality daisywheel printer designed specifically for home use.

JUKI 5520: low-cost, high quality dot matrix personal computer printer. High speed (180cps), graphic mode and optional 4-colour print function. NLQ.

JUKI 6100-I: brand-new, IBM*-compatible version of the best-selling 6100. Graphic mode and full word processing support. £399.-

JUKI

Technology true to type

28

JUKI (EUROPE) GMBH · Eiffestr. 74 · 2000 Hamburg 26 · F. R. Germany
Tel.: (0 40) 2 51 20 71-73 · Telex: 2 163 061 (JKI D) · Fax.: (0 40) 2 50 52 97.

Sole distributor: **MP Micro Peripherals Ltd** Intec Unit 3, Hassocks Wood, Wade Road, Basingstoke, Hants, RG 24 ONE.
Tel.: (0256) 47 3232 (32 lines) · Telex: 8 59669 MICRO PG, Facsimile (0256) 46 1570

● Circle No. 138

Rough and tumble

OLIVETTI is to acquire a 49.3 percent shareholding of Acorn. This follows the announcement of losses by Acorn of £10.9 million in the six months to 31 December 1984.

The company will be split up into four divisions: education and training; scientific and industrial; business; and consumer. A further 90 jobs will go in addition to the 30 redundancies already announced. Dr Alexander Reid, who joined the company recently as acting chief executive, is to become chairman, with Hermann Hauser and Chris Curry as joint deputy chairmen. A Group Managing Director is to be recruited externally.

Hauser and Curry's combined shareholdings will go down to 36.5 percent from 85.7 percent. Olivetti has an option to increase its holding to 50.1 percent within the next five years.

Olivetti's moves follows the suspension of Acorn's shares on Wednesday 6 February. They then stood at 28p against a 1984 high of 193p. On Friday 1 February, Acorn had sacked

its merchant bankers Lazards. As a result, its stockbrokers Cazenove resigned. Acorn has appointed Close Brothers as its new financial advisers, and Phillips and Drew as its brokers. The proposed takeover of Torch computers will not now take place.

Partly as a result of the adverse publicity resulting from Acorn's troubles, Sinclair has postponed its share flotation on the USM. Sinclair has also stopped taking deliveries of all its computers from sub-contractors. The company blames overstocking by retailers in the pre-Christmas period.

Meanwhile, Oric called in the receiver on 31 January. Debts stand at about £6 million; the book value of stock is about £3 million. According to the receiver, three firms are showing an interest in Oric. Two are French, and the third is continental with British connections.

The new owners of the Lynx range, Anston Technology, has announced that it will not restart production of the Lynx 48 and 96 for the U.K. market.

Support will continue for existing owners. Prices have been cut on remaining models. The Lynx 128 costs £299, down from £399; the 250K disc drive with controller costs £249, and the 1Mbyte version £269; all prices include VAT.

Things are not entirely quiet on the American front, either. The U.K. General Manager of Commodore, Howard Stanworth, resigned and left at the end of February. According to the company, the parting was amicable. No reason has been given for his departure.

Commodore earlier reduced the price of the Plus-4 from £299.99 to £149.99. Meanwhile, in America itself Commodore has laid off over 500 employees as a result of its high stock levels.

The only home-micro manufacturer looking bullish is Atari, under the ebullient leadership of Jack Tramiel. While the world waits for the ST supermachines — see interview on page 31 — Atari is offering a restyled 800XL, together with a 127K disc drive, for £249.99 including VAT, instead of the usual £364.96.

Microsoft Press

A YEAR AGO, Microsoft went into the book-publishing business in the U.S. and produced some excellent books, particularly about the Apple Macintosh. They are now to be distributed outside the U.S. by Penguin Books.

The initial offerings are *The Endless Apple*, *The Apple Macintosh Book*, *Running MS-DOS*, *Mac Work Mac Play* and *Managing your Business with Multiplan*. Titles on the way include *Learning Commodore 64 Logo Together*, *Getting Started with Microsoft Word*, *Word Processing Power* and *Putting dBase III to Work*.

Contact Penguin Books, 536 Kings Road, London SW10 0UH. Telephone: 01-351 2393.

Business Computer Show

THERE ARE more than enough computer shows already, so why launch yet another? The answer to that is: "Because this one is different".

The Business Computer Show is the first national exhibition to be aimed specifically at people who are not computer experts. The idea is to attract the small business user.

During the show a business advice centre will be run by the Department of Trade and Industry and the National Computing Centre. There will also be a communications centre, to feature the latest electronic mail, networking and messaging technologies.

The established exhibition, Software, sponsored by the Institute of Data Processing Management, will be held in the same place at the same time.

The Business Computer Show is being sponsored by *Practical Computing* and *Computer Weekly*, and supported by the British Computer Society and the Computing Services Association. The show will be held at Earls Court, London, from June 4-6. Admission is free.

Contact Reed Exhibitions, Surrey House, 1 Throwley Way, Sutton, Surrey SM1 4QQ. Tel: 01-643 8040. 

Celebrity Chatline

FROM MARCH 20 Micronet 800, the specialist microcomputer users group on Prestel, is launching Celebrity Chatline. Each Wednesday evening a computer celebrity will be interviewed live on viewdata, and everyone logged on will be able to type questions on to their terminal for the celebrity to answer. In other words, it is the computer equivalent of a phone-in.

From March 27, the celebrities taking part are Derek Meakin, publisher of *Telelink*, journalist Guy Kewney, Mike Singleton, author of *Lords of Midnight*, Paul Duffy of the guild of Software Houses against piracy, and Nazir Jessa of Watford Electronics.

For more information contact Micronet 800, Telemap Ltd, 8 Herbal Hill, London EC1R 5EJ. Telephone: 01-278 3143.

Books received

● *Micros for Handicapped Users* by Peter Saunders.

Published by Helena Press, £5.95 ISBN 0 9507930 2 7.

An excellent introduction to computing for those who are handicapped, and also an invaluable source book of addresses, information and ideas. The book covers North America, Australia, the U.K. and parts of Europe.

● *Mr Babbage's Secret* by O I Franksen. Published by Strandbergs Forlag, Denmark, DKr 320. ISBN 87 872 0086 4. An idiosyncratic book in the grand but short tradition of Hofstadter's *Gödel, Escher, Bach*. It weaves together such diverse subjects as Charles Babbage, APL, cryptography and Viking runes. An intriguing book, but not easy.

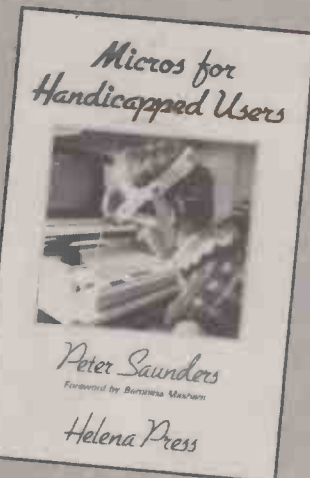

● *The Apricot Personal Computer* by M de Pace. Published by Collins, £8.95. ISBN 0 00 383002 0. A very basic guide to the Apricot and to programming in general. There are chapters on Basic, spreadsheets, word processing and databases. There is little of interest to the hardened user, but it is useful for beginners.

PLEASE NOTE OUR NEW ADDRESS
VISIT OUR NEW SHOW ROOM

MICRONIX ESB-1 32 BIT MULTIUSER COMPUTER

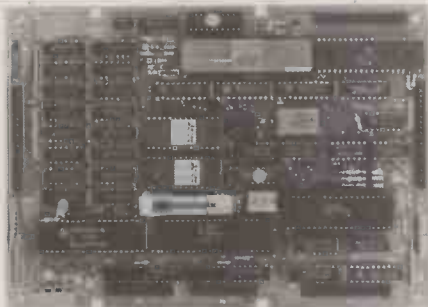

Two user twin drive system
with 256K RAM
£1600 + VAT
Terminal £ 400 + VAT

★ 68008 8 MHz CPU ★ 128 RAM (expandable to 256K) ★ Up to 64K EPROM
1 Floppy disk controller for 5¼", 3", 3½" drives ★ 2 RS232 serial ports
★ Mounts directly on 5¼" drive ★ 2 x 8 bit parallel ports ★ Full debug monitor
with single line assembler and disk loader ★ Expansion bus ★ Power
requirement: +5V/1.5A, +12V/100mA, -12V/100mA.

Available as a Bareboard with Monitor ROM and IFL Chip Set £199 + VAT =
£228.85 or completely assembled £499 + VAT = £573.85 128K Expansion
Board (recommended for OS9/68000) £199 + VAT = £228.85 - OS9/68000
real time, multitasking, multiuser Operating System (similar to UNIX)
£300 + VAT = £345 C Compiler, BASIC 09, PASCAL and FORTRAN available.
Single User CP/M68K £375 + VAT = £431.25.

THE ERICSSON PC

Fully compatible with IBM PC/XT
From £1,934 + VAT
★ 8088 CPU ★ Optional 8087 processor
★ 128K RAM ★ Built in hi res graphics
★ Twin half height drives (360K each)
★ Amber monitor with tilt & swivel
★ MS DOS 2.11 and GW BASIC
★ 1 Serial port ★ Parallel port (centronics)
★ 12 Month on site warranty

Free starter pack worth £500 until 30th April
1985
Free NLQ printer!
Free wordprocessing software!
Free box of paper (1,000 sheets)!
Free box of (10) diskettes!
Free printer cable!

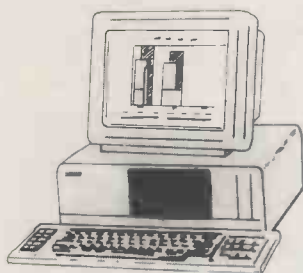

SWITCHED MODE PSU'S

Ideal for Computer Systems,
disk drives, terminals etc.

MODEL: MX100 (OUTPUTS):
+5V @ 10A, +12V @ 3A
-5V @ 1A, -12V @ 1A
£90 + VAT = £103.50

MODEL: MX45 (OUTPUT):
+5V @ 3A, +12V @ 2.5A
£50 + VAT = £57.50



PERIPHERALS FOR IBM PC/COMPATIBLES

64K RAM Upgrade — set of 9 x 64K RAM chips..... £ 30 + VAT = £34.50
256K RAM BOARD — ideal for ERICSSON PC..... £200 + VAT = £ 230
128K RAM Upgrade for IBM PC A/T —
set of 9 x 128K RAM chips..... £100 + VAT = £ 115

MONITORS

SINCLAIR Vision QL RGB

PHILIPS 12" green..... £100 + VAT = £ 115

DOT MATRIX PRINTERS

EPSON RX80 F/T 80 column, 100 CPS..... £240 + VAT = £ 276
EPSON FX80 80 column, 160 CPS..... £360 + VAT = £ 414

NEAR LETTER QUALITY (NLQ) PRINTERS

PANASONIC P1091 80 column, switch selectable 120 CPS
draft/22 CPS NLQ — switch selectable
for IBM PC or other Computers..... £300 + VAT = £ 345
KAGA 810 80 column, 160 CPS
draft/27 CPS NLQ..... £260 + VAT = £ 299

DAISY WHEEL PRINTERS

JUKI 6100 20 CPS, 2K buffer..... £340 + VAT = £ 391
FUJITSU SP320 48 CPS, Diablo, 4K buffer..... £980 + VAT = £1,127
Tractors and Sheet Feeders also available!

DISK DRIVES FOR BBC

Quality half height Japanese drives boxed and supplied with all cables,
formatter disk and DFS manual

MX150 — 100K Single
40 track, single sided (while stocks last!)..... £ 80 + VAT = £ 92
MX152A — 400K Single
80 track, double sided, 40/80 track switch..... £120 + VAT = £ 138
MX252A — 800K Twin
80 track, double sided, switched mode PSU,
40/80 track switch..... £260 + VAT = £ 299



METAL ENCLOSURES FOR SYSTEMS & DRIVES

Single drive box..... £10 + £2.60 P&P + VAT = £14.49
Dual drive box — vertical or flat type
(takes MX45 PSU — PSU extra)..... £20 + £5 P&P + VAT = £28.75
System box for ESB-1 (takes two
5¼" drives and MX100 PSU)..... £99 + £11 P&P + VAT = £126.50

VISA, ACCESS WELCOME



Ordering Information:

Prices are exclusive of VAT unless stated otherwise. Unless otherwise stated,
Postage/Carriage free within UK for advertised prices only — special or
discounted prices will attract postage/delivery charges at cost. All goods are
subject to availability and prior sale. Prices are subject to change without notice.
We accept VISA and ACCESS.

* Visit our brand new Showroom — off-street parking, nearest tube Kilburn
(Jubilee Line) OPEN MON-FRI: 9.30am — 5.30pm

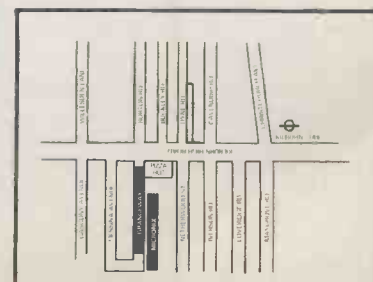

Enter the Jackintosh

To what extent will the ST be used in business?

I believe it will be quite substantial.

Will there be any distinct drive to sell it to business?

There will not. I will be selling it through individuals. And if any business is smart enough that they want to come and buy it from our dealer, they will be welcome. We will not have a business division, as such, trying to concentrate on the Fortune 500s.

You are offering Logo as well as Basic as the bundled language. Are you intending to give any kind of educational discounts in the way that Apple has?

We will definitely have special schemes for schools, but we don't need to do the same thing as Apple, because the Apple discounted price is twice as high as our normal price. It will be at all three levels of education.

What about future add-ons for the ST?

There are quite a few add-ons, especially in the hard-disc area, and in the music area. Then we are going to have a whole line of printers.

Are you going to bring out a laser printer?

We are working on a laser printer but not for this line. It's for our next generation.

Will the next generation be 32-bit?

Yes, it will be.

Will it be based on the 68020?

When you see it you'll know about it.

When can we look forward to the next generation?

It will definitely be this year.

Will it be TOS compatible?

No. This is the one area a lot of people do not understand. When you work with technology, you don't go backwards, you want to go forwards. If it's feasible and possible to have it compatible, you will. But if technology is that far ahead of the previous machine, then they won't be compatible.

More generally, how do you see the next generation of computers developing?

I think much more capacity, much faster speed, much more multi-tasking networking, and having very, very large databases almost built into the machine.



JACK TRAMIEL, Chairman and Chief Executive Officer of Atari — interviewed by Glyn Moody.

Jack Tramiel founded Commodore Business Machines in 1955 as a firm manufacturing typewriters and adding machines. In the 1960s it moved into the electronic-calculator field, and in 1977 into the world of micros with the first of the Pet series.

Early in 1984, Tramiel left Commodore because "I could no longer come into work with a smile on my face." Later that year he acquired the ailing Atari from Warner Communications, together with estimated debts of around \$400 million.

Only a few months later, Tramiel announced new machines at the Consumer Electronics Show in Las Vegas that astonished the micro world. Chief among the wonders unveiled there was the ST series. Based on the powerful Motorola 68000 chip, the 130ST offers a Macintosh-like environment with 128K RAM for only \$399. The 512K version, the 520ST, costs \$699. Peripherals include a 3.5in. 500K floppy for \$100, plus a range of monitors and printers.

What uses do you see this power being put to?

For a doctor, for example, instead of having to wait for some information, such as what is the newest thing on cancer, or to see what people have done when this case has come up before, he will have a database on that particular sickness. He'll go to his computer and in seconds he will have the information in front of him.

Are you talking to information providers about setting up co-production deals?

Yes. Those are the kind of things I want to

bring — those kind of libraries — to the individual, so that you don't have to be a huge corporation to afford this kind of information. The kid which has a coal miner as a father will now have this kind of information. And maybe he won't have to be a coal miner, he can be a businessman, he can be a doctor. A machine like this only 10 years ago was a half a million dollars, where now you might be able to buy it for a thousand dollars. So we're bringing the computing power to the individual. That's what I want to give to the end-user.

Do you see that tying in with things like interactive video?

There's no question. There is a company called Plato, who have more than 2,000 educational programs — really advanced programs — which were being taught in high schools. All of sudden we were able to take those 2,000 and put it on a little disc.

How do you think the micro marketplace is going to develop in the future?

I believe that it's going to settle down. I have never taken any company seriously which did not have an international base. To be successful in the micro business you have to think internationally, not nationally. As soon as you are caught up in your own country and can't look worldwide, you don't have a market worldwide, and you don't make it.

Do you think that the British efforts are rather small-scale and parochial?

That's right. I would work with the British government, on how can we make a computer that is good for the world, not good for Britain.

How do you regard the MSX idea?

MSX, I think, was basically a fantastic idea for Microsoft to sell software. But it was very backward technology, going to a Z-80 which was technology from 10 years ago. So my friend Mr Gates has done a fantastic marketing job. Thank God they failed.

So do you see things driven fundamentally by technology?

No question. That, I believe, is our success. I always believed that micro-computers were technology-driven not marketing-driven. You always have to be your biggest competitor. Try to make every time a better product to compete against yourself. Never fall in love with the product that you have right now, but if there is better stuff out there, make it. 

BUSINESS COMPUTERS ARE BIG BUSINESS IN THE NORTH

The
Northern
Computer
Show '85

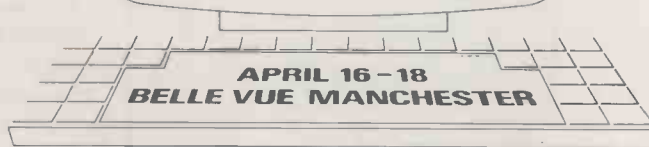

THE NORTHERN COMPUTER SHOW WILL HELP YOU REACH THAT BUSINESS

The UK is one of the world's biggest single markets for computers. The latest estimates put total hardware sales at around £2,250 million in the last year plus around £1,000 million of software and services.

The North of England will take its share as a major growth area for all kinds of computers, software and peripherals for business use. Yet how do you get your share of this booming market?

There's a simple answer. Take a stand at The Northern Computer Show — the ONLY computer show for serious business users and DP professionals in the North of England.

The new Northern Computer Show incorporates Compec North — making it bigger and better than ever before.

Not only will this new event attract the computer professionals who normally go to Compec North, it will also open the doors to a vast number of business people who are aware of computers and eagerly want to know more about them.

Add them together and you have the biggest 'dedicated' audience in the North.

So make sure of your share of the market. Phone Fiona Howell on 01-661 3125 for the latest details of The Northern Computer Show. Or Complete and return this coupon to her at: The Exhibition Sales Department, The Northern Computer Show, Quadrant House, The Quadrant, Sutton, Surrey SM2 5AS. Telex 892084 BISPRS G.

BELLE VUE, MANCHESTER 16-18, APRIL 1985

I am interested in exhibiting. Please send me full details etc.

NAME _____

JOB TITLE _____

COMPANY _____

ADDRESS _____

TELEPHONE _____ TELEX _____

Return to Fiona Howell, Exhibition Sales Department, The Northern Computer Show, Quadrant House, The Quadrant, Sutton, Surrey SM2 5AS.

The
Northern
Computer
Show '85



A Computer Weekly
Exhibition

PC

JENTECH COMPUTERS OFFER

a 3 user multiuser multitasking computer and software

TRIO 1

MOLECULAR COMPUTERS



Dealer and End User enquiries welcome

FROM **£3999**

EX. V.A.T.

JENTECH COMPUTERS OFFER

SMITH CORONA

NEW GENERATION OF DOT MATRIX PRINTERS



Postage
will be
paid by
Jentech

FOLD AND TEAR HERE AND POST

To Jentech Services Ltd.,
FREEPOST
Smithfield Centre,
Whitburn Street,
Bridgnorth,
WV16 4QP.

Please send details on:-

MOLECULAR COMPUTERS
SMITH CORONA PRINTERS

BUSINESS RISK ANALYSIS

HEADS TAILS OR...

...OPTIONS?

OPTIONS takes over where your spreadsheet leaves off! Produces a thousand 'what if' results in seconds! OPTIONS picks you up where a spreadsheet lets you down. It's like no other program currently available.

Picture the scene. You've painstakingly set up a business model on your spreadsheet. All the facts and figures are there and everything looks perfect. Then the inevitable happens. The 'what if' questions start coming thick and fast.

'What if' sales vary by 8%? 'What if' material costs increase by 10%? 'What if' the unions push us into an extra 7%? 'What if' oil costs vary by 5%? 'What if' interest rates vary by 2%? 'What if' our selling costs increase by 10%? etc. etc.

And 'what if' you had a program which applied all these variables to your model and cash-flow forecast **and gave you all the answers in seconds.** Not just a single answer but the whole range of risk possibilities. Show you both numerically and graphically, the chances of achieving varying degrees of success and failure - profit and loss - related to the variables you apply. The kind of information you need to plan your business and bank managers just love to see!

OPTIONS is that program. A new concept in business risk analysis. No other program does the job with such speed, flexibility, and accuracy. OPTIONS allows you to take a model

created on your favourite spreadsheet Lotus 1-2-3, Multiplan or Supercalc and manipulate it in this powerful new way. If you have no spreadsheet no problem! OPTIONS has its own. For only £145 + VAT you can have all the answers to every 'what if' question they can throw at you. Instantaneously!

£145 + VAT

SAGE OPTIONS™

Please send me more details of Sage OPTIONS and my nearest dealer.

Name: _____ Position: _____

Company: _____

Address: _____

Tel: _____

I have a (_____) Computer

Sagesoft Limited, NE1 House, Regent Centre, Newcastle upon Tyne NE3 3DS.
Tel: 091 284 7077. Telex: 53623 SAGESL G.

BETTER SAGE THAN SORRY

PCI



IN THE BEGINNING, there was low-resolution monochrome graphics. Micro-computer screens were divided up into character cells, and the screen-refresh memory consisted of about 1K of RAM with each byte containing either a standard ASCII character or a code to select one of a range of special graphics characters.

Screens could handle about 24 lines of 40 characters per line, and the definition of each character was stored in a special character-generator ROM which described each character on a dot matrix of about six by eight points or pixels. By this means the puny 1K screen memory could provide an apparent dot resolution of 240 by 192 pixels, but with the important proviso that a sort of indirect addressing into the character ROM was necessary to access individual pixels. To write pictures rather than words on the screen, special graphics building blocks had to be available in the character-generator ROM. To produce a particular picture, first character cells and then appropriate graphics characters had to be selected by the program — an arduous business even on those few machines with RAM-based character generators.

Cheaper memory

As memory prices fell and screen-refresh memories could be increased in size, it became possible to address pixels directly rather than via a character generator and the so-called bit-mapped graphics approach became standard. Screen resolution of 128 by 128 became possible using 16K DRAM chips for example, and up to 512 by 512 with the more recent 64K DRAMs. All the earlier systems, whether character- or bit-mapped, used only one bit per pixel. So the lucky graphics programmer had a choice: pixels could be either On or Off.

With memory prices dropping ever lower, it became possible to store more than one bit per pixel, and this provided the next improvement: colour. Even with only two bits per pixel, it was now possible to have a choice of one of three primary colours as well as Off. As more bits were added the possibilities increased in powers of 2.

Far from perfect

The current state-of-the-art for the most sophisticated personal computers would be a 512- by 512-pixel screen with eight bits per pixel using, say, eight 256K DRAM chips and providing 256 colour possibilities. When you see such a screen it certainly looks very good, but it is still far from perfect for many tasks such as computer-aided design so the race is on to achieve better still.

If you have sufficient funds you can have the next stage today. It provides 1,024- by 1,280-pixel resolution, up to 16.8 million colour hues per pixel — and you don't get much change out of

Looks fine

Handling very detailed displays requires a complete rethink of the graphics circuitry. A new VLSI chip family has just arrived to take on the task.



Conventional technology limits resolution, even for CAD work stations where detail is most needed.

£100,000. The problem is that after 512 by 512 pixels, system design becomes a whole new ball-game because that is about the highest resolution that can be achieved on current 525- and 625-line monitors.

Going up to 1,024 by 1,280 requires a lot more than just 1.25Mbyte of memory. It also requires a completely new colour CRT design and some sophisticated analogue electronics. To prevent flicker, any raster scan display, regardless of definition, has to have a frame-refresh rate of 50Hz or more. On a 625-line 512 by 512 graphic screen, individual pixel data has to be clocked at around 10MHz to keep up with the raster. On a 1,024-line, 1,024-by 1,280-pixel screen, the dot-clock rate approaches 100MHz — and that's VHF.

Put 1.25Mbyte of RAM, an exotic CRT and VHF-drive electronics together, and you can see why really high-resolution graphics are only available to the chosen few at the moment. Fortunately for us technology marches on, and when your 1990s-vintage machine emerges from its chrysalis don't even look at it unless it sports 1,024 by 1,280 resolution. Nobody can doubt that the screen-refresh memory will be cheap enough by then: 1Mbit DRAMs are already running in the labs. The CRT technology already exists in Japan, and with the forthcoming introduction of high-resolution television direct-broadcasting by satellite a mass

market will emerge to bring CRT prices down.

As far as the drive electronics are concerned some companies are already hard at work putting the necessary ingredients on to LSI chips, as a new family of high-resolution graphics chips from AMD demonstrates. The team consists of the Am 8150 video-shift register and the Am 8158 video-timing controller. Together they provide just about everything required to build very sophisticated graphics systems indeed.

The Am 8150 takes charge of up to 1.25 million words of screen-refresh memory and arbitrates between the conflicting requirements of the processor, which wants to asynchronously write new graphics data into the memory, and the screen, which has to be updated at the raster rate. In addition, it provides all the fancy addressing to allow smooth panning and scrolling.

The Am 8157 is needed to increase the apparent speed of the memory array. Fast dynamic RAMs have access times of about 100ns., but to write 1.25 million pixels 60 times a second, access times of less than 10ns. are necessary. The video-shift register can be loaded with up to 20 bits at a time which can then be shifted out serially at clock rates of well over 100MHz. The Am 8158 provides the necessary heartbeats for the whole system, generating vertical and horizontal sync pulses, blanking pulses, and the dot and character clocks from a crystal oscillator running at up to 125MHz.

16 million hues

Pride of place goes to the fantastic Am 8151 colour palette, three of which provide the colour maps to drive three eight-bit colour channels, giving a possible colour range of 16.8 million hues. Each Am 8151 colour channel has a 256 by eight high-speed RAM-based look-up table and a fast eight-bit digital to analogue converter which provides the analogue video output.

The look-up table approach provides a 24-bit dynamic colour range, but requires only eight bits of data per pixel. In effect, the eight-bit picture data is encoded into 24-bit form and although at any one time only 256 colours are available, the programmer can reload the tables at any time. A nice touch is the incorporation of a text-overlay facility which produces a whiter-than-white image from a binary memory plane so that text always shows up, even on white graphics.

THE PRICE IS RIGHT!

Look at this list of machines – all ex-demo stock.
Mostly unmarked and in mint condition –
AND THEY MUST BE CLEARED!!

Equipment	Qty	RRP	Equipment	Qty	RRP
COMODORE			SANYO		
64 Computer	- 2 only -	199.13	144.00	MBC 555 128k & Mon.	- 1 only - 999.00 798.00
1540 Disk Drive	- 1 only -	199.13	152.00	TIGER	
MPS 801 Printer	- 2 only -	200.00	149.00	264K x 2Mb & Colour & Monitor + Software	- 1 only - 2700.00 1995.00 (or sensible offer)
MCS 801 Col. Printer	- 2 only -	346.00	299.00	EPSON	
8096-SK Computer	- 1 only -	795.00	630.00	PX-8 Portable	- 1 only - 798.00 598.50
8296 Computer	- 1 only -	795.00	670.00	SIRIUS I	
8050 1 MB Dual Drive	- 1 only -	895.00	600.00	128K x 1.2Mb & Monitor	- 1 only - 2195.00 1550.00
8250 2 MB Dual Drive	- 1 only -	895.00	750.00	OTHER PRINTERS	
8027 Printer	- 1 only -	850.00	395.00	Centronics 737	- 1 only - 399.00 200.00
3022 Matrix Printer	- 2 only -	395.00	149.00	GP700A 4 Colour Matrix	- 1 only - 495.00 300.00
2023 Matrix Printer	- 2 only -	395.00	125.00	Smith-Corona Daisywheel	- 1 only - 395.00 199.00
9090 Hard Disk	- 1 only -	2495.00	1395.00	Centronics 779	- 1 only - 795.00 200.00
APRICOT					
256k x 630k & Monitor	- 1 only -	1795.00	1390.00		
F1256K x 720K	- 1 only -	1095.00	875.00		

MANY OTHERS – PHONE & ASK!

**STOP PRESS! PLUS 4 ONLY £130.42!
SX-64 ONLY £499.99!**

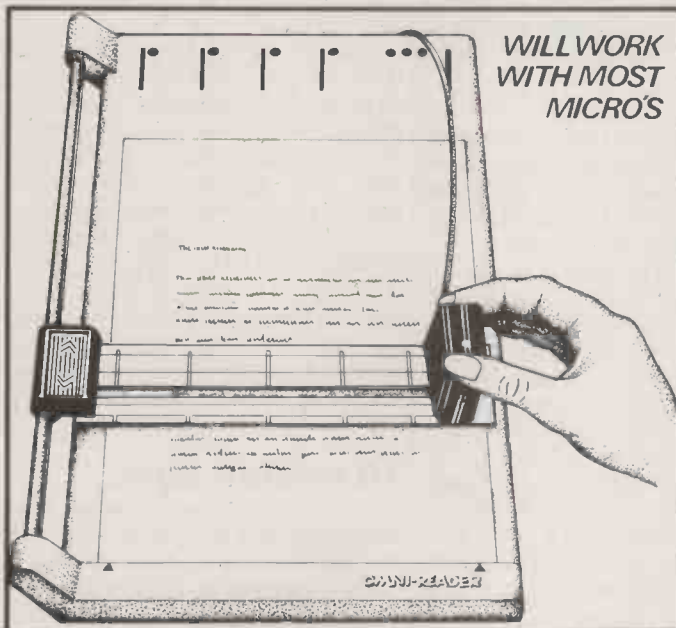

A REVOLUTION IN TAKING WORDS FROM PAGE TO COMPUTER

The OMNI-READER can read text into most word processors, micro and personal computers. It attaches through a Serial RS232C interface as easily as a modem.

The OMNI-READER comes pre-programmed to recognise the most commonly used typefaces.

APPLICATIONS

- Word processor input – entering existing documents.
- Transferring text between incompatible computer/word processor systems without the need for re-typing.
- Inputting tables of data, or new data into spreadsheet or database programmes.
- Entering text for electronic mail.
- Storing and editing documents for electronic filing.

AND IT ONLY COSTS £399!

EASULINK

WORLDWIDE LOW COST TELEX
DIRECT FROM YOUR DESK!

THE MOST EFFECTIVE WAY TO BETTER BUSINESS COMMUNICATIONS. Allows you to connect to UK & INTERNATIONAL TELEX networks using your existing MICRO, with Hardware & Software... Enables you to start from as little as £100!

We carry a wide range of SOFTWARE for all our machines, including WORDPROCESSING packages and SPREADSHEETS.

Most SOFTWARE is available ex-stock.

Specialist applications and bespoke programs also catered for.

Call us for info on our Cash Book and Bar Stock Records programs!

ALL PRICES EXCLUDE VAT

One of Commodore's
top UK dealers!

L & J COMPUTERS

192 HONEYPOT LANE, QUEENSBURY, STANMORE, MIDDX. HA7 1EE. 01-204 7525



PERSONAL SHOPPERS WELCOME
Phone & Mail Orders accepted

ALL GOODS SENT SAME DAY WHEREVER
POSSIBLE LARGE S.A.E. FOR LISTS ETC.



infomata are proud to present the **POLICY MASTER** from CSA Microsystems, the answer to every General Insurance Brokers paper mountain.

POLICY MASTER has been specifically developed to meet the requirements of today's General Insurance Broker, and meets all B.I.B.A. constraints.

Many brokers find themselves buried within a mass of day to day administration. They sit in front of a pile of paperwork when they would rather be sitting in front of a client.

POLICY MASTER condenses the time consuming aspects of the O/B Insurance Industry to enable you to concentrate on the most important aspect of your business . . . your clients, and potential clients.

Five systems combine to make **POLICY MASTER** the perfect package for brokers.

● **ACCOUNTING SYSTEM** controls interacting client, insurer, bank and commission ledgers.

ADOPT THE RIGHT POLICY WITH INFOMATA!



● **POLICY/RENEWAL SYSTEM** allows complete control of policies, renewals, reminders, accounting and cash flow.

● **MEMO PAD SYSTEM** provides a free format (Policy Jotter) for maintaining and printing policy schedules and file notes such as claims histories. It also provides a fixed format 'client profile' and a free format 'client Jotter' for selective information retrieval and mail shot word processing.

● **DIARY SYSTEM** monitors day to day business, schedules daily tasks, detects and highlights outstanding or overlooked action.

● **WORD PROCESSING INTERFACE SYSTEM** offers automatic letter and mail shot printing.

POLICY MASTER is such a versatile software package that Infomata can implement it on most current and forthcoming single and multi-user micro computers. However, after extensive research, Infomata recommends that **POLICY MASTER** be implemented on the Delta 505 Micro Processor.

The Delta 505 is a compact, British built microprocessor, with integral disk storage, and industry standard communications facilities. It can be connected to external services such as Telex or Prestel and as your applications needs expand the storage capacity can be extended in stepped options, from its useful 10 mb to a huge 20 mb of high performance Winchester disks.

Infomata will be holding their next seminar at St James Court in Warrington on 11 April 1985. If you would like to see **POLICY MASTER** in action on the Delta 505 or if you would like more information ring Terri Pope of Infomata on Warrington (0925) 572870.

With over sixty years total experience in business computing, consulting Infomata would certainly seem to be a case of adopting the right policy.

infomata
computer system consultants & suppliers

Gilbert Wakefield House, 67 Bewsey Street, Warrington, Cheshire WA2 7JQ. Tel: (0925) 572870. Telex: 627702.

● Circle No. 141



RM NIMBUS

A NEW BREED OF MICROCOMPUTER

POWERFUL. FLEXIBLE. AFFORDABLE.

RM Nimbus. New from Research Machines, British manufacturer of high-quality microcomputers and networks.

RM Nimbus. An entirely new 16-bit machine with remarkable power, versatility and speed. And with built-in capacity to expand its memory, storage, networking and interfacing.

FAST, POWERFUL, VERSATILE

Nimbus is probably the most advanced 16-bit machine for its price.

It evolves from a completely original design concept, based on an 80186 8MHz processor, VLSI gate array technology, dual-bus architecture, and a separate graphics processor. It shows an amazing turn of speed and an insatiable capacity for work, whether as a professional business machine, a research and instrumentation tool, or a local network station.



ORIGINAL FEATURES

Among the many totally new ideas incorporated in Nimbus is Piconet, a unique input/output system which enables the



computer to drive up to thirty peripherals, instruments or devices from a single I/O port. In fact there are more interface options with Nimbus than you may ever need.



MODULAR, UPGRADEABLE

Within the same neat unit, you can specify Nimbus with single or twin 3½" disc drives. With a built-in Winchester. Or without discs as a network station. And talking of networks, Nimbus uses the MS-NET* operating system, which will allow up to 64 stations

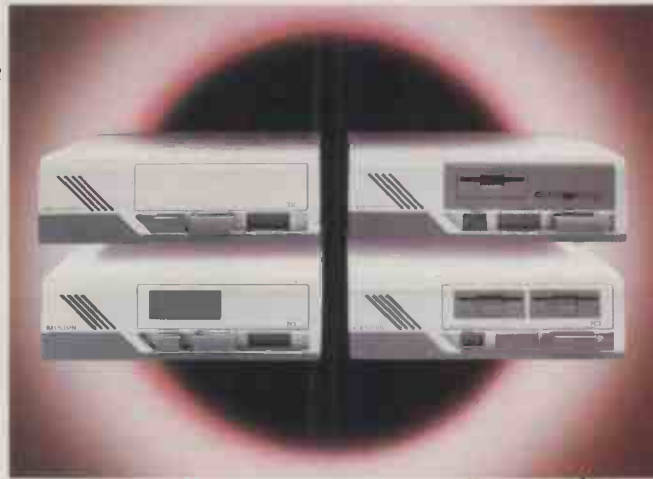

to share software and network facilities at high speeds.

MORE SOFTWARE THAN EVER

With its MS-DOS* operating system, Nimbus will have access to the world's largest library of professional 16-bit software. And the power to handle the most sophisticated languages and



applications, now and for years to come.



UNBEATABLE VALUE

As a stand-alone computer, Nimbus competes on price terms with any other comparable micro. As a network system, it leaves the others far behind.

For example, Nimbus PC 2 (192K RAM, two 720K 3½" disk drives) costs £1695.**

There is much about Nimbus that cannot be conveyed in words. Its superfast graphics, for instance, or its elegant, user-friendly design. To find out more about Nimbus, use the coupon below, or phone Research Machines on Oxford (0865) 249866.

*MS-DOS and MS-NET are trade marks of Microsoft Corporation.
**Prices do not include VAT.

To Caroline Rawle,
Research Machines Ltd,
Mill St., Oxford.
Tel: Oxford (0865) 249866.

Please send me full details of the new RM Nimbus

I should like to attend a Research Machines Open Day

Name _____

Position _____

Address _____

Tel: _____ PC 4

RESEARCH MACHINES
MICROCOMPUTER SYSTEMS

Tandy® The Model 4P - Power & Portability At A Truly Unbeatable Price!

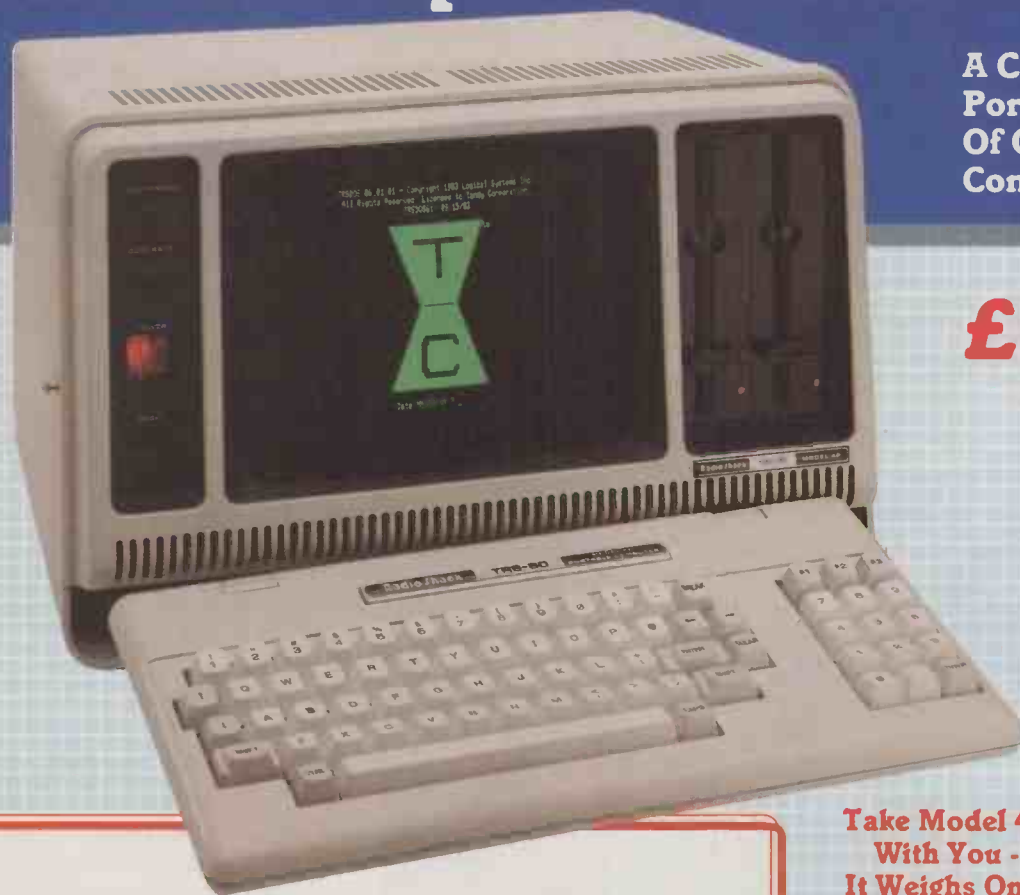

A Completely
Portable Version
Of Our Model 4
Computer!

£999

Exclusive of VAT



Take Model 4P
With You -
It Weighs Only
26 Pounds!

Specifications:

Microprocessor: 4 MHz Z-80[®] A (2 MHz in Model III mode).
Memory: 64K RAM, expandable to 128K. Provides for disk drive emulation in RAM, only 64K addressable from BASIC. **Keyboard:** 70-key typewriter-style with datapad, plus CONTROL, CAPS and 3 programmable function keys (F1, F2, F3). **Video Display:** 80 x 24 (Model 4 mode), 64 x 16 (Model III mode), or double-width 40 or 32 characters per line. Upper and lower case. Reverse video (Model 4 mode), 96 text, 64 graphics and 96 "special" characters. **Language:** Microsoft 5.0 BASIC. **Sound:** Obtainable from BASIC. Toggled "keyclick". **Disk Drives:** Two built-in double-density 184K 5¼" drives. **External Connections:** Parallel printer port, RS-232C serial port. **Dimensions:** 16½ x 13¼ x 9¾". **Power:** 240 VAC, 50 Hz.

Our versatile Model 4 is a truly portable unit, and will run all Model 4 disk software and also Model III TRSDOS and LDOS disk programs (in Model III mode) without change - so a huge library is already available. Model 4P is compatible with the CPM Plus* operating system which opens the door to literally thousands of applications! The TRSDOS 6 operating system lets you use extra memory as a superfast disk drive.

Unlike some transportables, it's big on features, such as a full 80-character by 24-line 9" green display that can be upgraded to provide optional 640 x 240 high resolution graphics. Its full-size keyboard features CONTROL, CAPS and three function keys. A 64K memory as standard and a 128K option means it is ideal for larger tasks.

The Model 4P is ready to go to work in any small business - you can prepare accurate balance sheets and income statements for a fast analysis of your company's profits, improve your cash flow by monitoring your receivables to speed up collections and identify bad debts, and optimize your payment schedule for maximum efficiency.

Thoroughly documented, the Model 4P comes with Microsoft** Disk BASIC and TRSDOS 6 operating system, owner and programming manuals, reference card, and an introduction to your computer that gets you started immediately. Housed in a hi-impact ABS case with built-in carry handle.

Model 4P. 26-1080 £999.00
Model 4 Desktop Version. 1 Disk Drive. 26-1068 £849.00
Model 4 Desktop Version. 2 Disk Drive. 26-1069 £999.00

All Prices Are Exclusive of VAT

*CPM Plus TM of Digital Research **Microsoft TM of Microsoft Corp.

Take A Look At
Tandy Today

Visit your local store or dealer and ask about our expanding range of microcomputers and software - we service what we sell!

See Yellow Pages For Address Of Store Nearest You

Tandy®

Tandy®

COMPUTER CENTRE

Available at all Tandy Computer Centres and at Tandy stores and participating dealers

Send For Further Information to:

Computer Marketing, Tandy Corporation (Branch UK), Tameway Tower, Bridge Street, Walsall, West Midlands. WS1 1LA

Name

Address

Post Code Tel. No. PC14





COMPUSERVE is one of the largest and most popular information systems for U.S. computer users. The system started in the 1960s as a fairly boring computer bureau for small users who needed to run, say, accounting programs, but could not afford a computer. Compuserve found that while its computers were being used heavily in the daytime, throughout the night they were doing little but run adventure games for the benefit of the night-shift operators.

Then a bright chap in the company suggested that Compuserve put some interesting information on the system and allow home-computer users to log on, charging them for the privilege. The jumped-up Bulletin Board System, BBS, that resulted was called Micronet — no relation to the more recent section of Prestel that operates under the same name.

Extensive facilities

Micronet has since changed its name to Compuserve Information System, CIS, and has grown to fill over 40 DEC 10 mainframe computers. Even the extensive facilities of Prestel, which occupies six GEC minicomputers, pale in comparison to the amount of computing power available on CIS.

CIS provides services in three main areas: business, home and computing. Under business and home you will find all the usual services, much like Prestel. These include news, stock and share prices, weather reports, teleshopping facilities, TV, film and product reviews, plus hundreds of other things. However, the services provided specifically for computer users are the most comprehensive, and worth discussing in more detail.

In keeping with its BBS roots, special interest groups or Sigs are provided for most U.S. brands of microcomputer. In these areas you can leave messages for other users or pleas for help. There is also an excellent electronic computer magazine — I write for it — with a news section which is updated throughout the day.

Chatty users

However, the most fascinating and addictive part of CIS is CB Simulator, a sort of electronic version of Citizens' Band radio. In this area, users can chat to each other via their keyboards, which makes it somewhat like Chatline on Micronet 800. You type a message on your keyboard, and some time later everyone else on Chatline gets it on his or her screen. The difference between Chatline and CB Simulator is that on Chatline it can take between three and 30 minutes for your message to appear, whereas on CB Simulator messages appear instantly.

As its name suggests, CB Simulator is set up very much like CB radio. The Simulator is run on two mainframes called, imaginatively, A and B. On each

Handle with care

The U.S. cult communications system CB Simulator looks set to win some British addicts.

mainframe there are 36 channels which you can "tune" into. Anyone on a particular channel can only "broadcast" to other people tuned into the same channel. As about 50 people can be on each channel, the theoretical maximum number of CBers, as they are called, is 3,600 at any one time.

On CB Simulator "everyone is totally equal. It doesn't matter what sex or race you are or what you look like, or handicaps or whatever. People judge you on your ideas, on how you communicate."

Pat Phelps,
Product Manager, CB Simulator
(Handle: Looloo)

When you enter CB Simulator, you are asked what handle you want — as in CB, handles are used instead of names. Then whenever you send a message, the system will automatically add your handle to the beginning, along with the mainframe and channel identification, so no one gets confused.

CB Simulator is very addictive. Just imagine having a conversation where 20 or 30 people can all talk at the same time. You can become quite attached to other CBers, and a number of couples have actually got married. The first couple to meet on the system and marry even had a terminal at their wedding on St. Valentine's Day, 1983. The proceedings were entered so that the bride's parents, who "witnessed" the wedding on their own computer, and all their CBer friends could join in. When the same couple had their first baby last year, there was a terminal in the delivery room.

The problem with chatting via a computer is that you cannot see or hear the other person, but the meaning of a spoken sentence is often shaped by the intonation and the facial expression which accompanies it. Obviously a line of text on a VDU cannot convey expressions, so CBers

add stage directions between < > symbols at the end of their messages. A typical interchange might look like

(A1, Old Man) Does anyone know what the time is?

(A1, Big Mama) Way past your bedtime <smile>!

(A1, Old Man) Hm. . . <frown>

or

(A20, Ricky) Hi everyone!!!

(A20, Mystery Lady) Hello Ricky!! <HUGS

& KISSES>

You get used to it after a while.

Unfortunately, you cannot simply dial CB Simulator directly from Britain. You need to get hold of a Compuserve starter pack, and these are only available in the U.S. What is more, Compuserve will not mail one over to you. You have to get a U.S. dealer to do so.

Password supplied

Starter packs contain a manual, an ID number and a password and cost either \$20 or \$40, giving you one hour and five hours free connect time respectively. When you log on to CIS with your starter pack ID you will be given the opportunity to sign up fully, giving your credit-card number for billing purposes.

The connect-time charges are very high compared to services in the U.K. Prime time is about \$13 per hour. The cheap rate is \$6 per hour. These charges do not include your PSS charges of £6 per hour, or the cost of the call to your local PSS exchange.

My ID on CIS is 72236,3112. My handle on CB is UK Ben. Send me a message when you join. But remember that in the U.S., CB Simulator addicts often run up bills of £1,000 per month, so be careful. Contact Compuserve Inc., at 5000 Arlington Center Boulevard, Columbus, Oh 43220, U.S.A. Telephone: (U.S. area code 614) 457-8600. 

Ben Knox can be contacted via snail mail *clo Practical Computing*, or electronically on Telecom Gold: 84:TCC051, or Prestel mailbox: 919993567, or on the Thames TV/Homelink Bullet — details of that next month.

Practical Computing is also on Telecom Gold: 81:JET727. The Editor is on 83:JNL020.



Castaway on a knowledge Island?

In the modern office, personal computers, however sophisticated, have one major drawback.

They tend to maroon their users on a series of knowledge islands.

With communications getting shipwrecked along the way.

The problem is, shared information means shared resources. Which is not what PCs were designed for.

Unfortunately, trying to network your PCs by adding more of the same, rigged together with a jumble of cables, is also taking the wrong tack.

All you get is an expensive duplication of hardware – and a compromise in performance. And the more users you add, the worse the problem becomes.

Happily rescue is in sight.

The Minstrel 2 multi-user system. The system with built-in networking.

With Minstrel, a central processor drives a powerful operating system.

While additional processors (think of them as complete 8 or 16 bit computers with their own memories) are allocated to each user.

More processors can be slotted in, just when and where the need arises.

Thus you can start with a small number of stations, confident that more users can be added at any time – each at a fraction of the cost of a stand-alone micro.

In fact, the Minstrel 2 starts at just £6,250 for a 2 user system. And each additional user will only cost you about £1,100 – with no hidden extras.

What's more, Minstrel systems can be specified with integrated electronic mail, telex, Prestel, Easylink – in fact, all the tools of the office of the future.

For further information, ring today or post the coupon for a free full colour brochure.

It's the quickest way to get off the knowledge island and back to civilisation.

To: HM Systems Limited, 220 The Vale, London NW11 8HZ
Tel: 01-209 0911 Telex: 266828-HMS G Easylink: 1900 1060
Please send me your free full colour brochure about Minstrel 2.

NAME _____

POSITION _____ COMPANY _____

ADDRESS _____

MINSTREL 2
The evolutionary computer.

PC4/85



More into less

Some more ways to save space and speed up program execution.

DATA COMPRESSION is the art of squeezing more and more information into fewer and fewer bytes. It is a subject that continues to attract the interest and attention of programmers. After all, if you can find a way of packing two eight-bit values into a single byte, you only save substantial amounts of RAM or disc space. You also benefit from faster table searches and disc accesses, which means speedier programs.

In June last year, Software Workshop looked at a method of compressing natural English text to just 49 percent of its normal length, without any loss of information. The scheme works partly by using the in-built redundancy in the ASCII coding system, which has 161 wasted values when representing text, and partly by assigning fewer bits to the commoner letters and words than to obscure ones.

The technique works beautifully for correspondence, articles, reports, etc., written in normal English, though it can be adapted for other languages. But if you tried to use it for other types of information, such as spreadsheet data or a name and address list, you would probably end up with a file that was many times larger than the original.

So what the programmers need is a collection of compression techniques, so that they can choose the method that is most appropriate for a given type of data. One possible method is designed for ordered lists, particularly alphabetical word lists such as dictionaries. A second method is a technique commonly used to compress bit-mapped graphics.

Common letters

The dictionary-compression scheme is based on the fact that in any alphabetically-sorted list of words, groups of neighbouring words will tend to have the same first few letters in common. So you can save space by recoding each word as a number followed by some letters, the number being simply a count of the letters copied from the previous word.

For example, the list
 exert, exhibit, exhibition, exile, exist, exit
 would be recoded as

exert, 2hibit, 7ion, 2ile, 3st, 3t
 You can achieve a further reduction by eliminating the space character, or other delimiter, that marks the end of each word. Instead, you detect the end of a word by looking out for the numeric char-

acter that introduces the following word. Of course, this assumes that digits never appear in their own right in the list and that the count is always present. So a count of zero must be inserted if no letters are carried forward from the word before.

You can then go a stage further by storing each character of the compressed text — that is each letter or count — as a six-bit number rather than in a full byte. This could be done by assigning the values 0 to 16 to the counts, and 17 to 42 to the lower-case letters, a to z. This still leaves 21 values free for hyphens, apostrophes, shift characters and the like.

To get an idea of the overall space savings that these techniques can achieve, it is worth looking at Wayne Holder's superlative program *The Word Plus*, marketed by Oasis Systems. It would denigrate this program to refer to it merely as a spelling checker but it does include a 45,000-word dictionary which the publishers were anxious to squeeze on to a single-sided 5.25in. floppy disc. The original dictionary ate up 450K. By using all of the tricks described here the author managed to reduce it to 140K, a saving of 69 percent.

Sequential searching

The snag with this type of compression is that you can only retrieve words by scanning the list sequentially, rather than by faster means such as a binary search. But this is not as bad as it sounds. In some applications, you are stuck with sequential searching anyway. The hypothetical travel enquiry service described in last month's *Software Workshop* is an excellent example because the search has to proceed at the same time that the searched-for value is being obtained from the keyboard.

You can also speed up the search considerably by employing a thumb index, which is another technique used by *The Word Plus*. This is simply a set of pointers to the first word beginning with each of the 26 letters of the alphabet. The slowest possible search in *The Word Plus* dictionary is for the word "systole". This is because s is the commonest initial letter in English and systole is the last word in the dictionary beginning in s. Using a Z-80 based Kaypro 10 with a hard disc, a search for it took under two seconds.

Searching *The Word Plus* dictionary can be great fun, especially if you are fascinated by words or addicted to crossword puzzles. The software includes a pattern-matching routine, which makes use of wild-card characters, and an anagram finder. If you have always wanted to know

(continued on next page)

How much space is saved?

The amount of space that you can save by dictionary compression depends on how close successive entries are to each other in alphabetical order. As a worst case, consider a list in which each word begins with a different letter. The compressed list would consist of the original words, each preceded by a zero count. Since the count would serve in place of the inter-word delimiter, the net reduction of space would be nil. A saving of 25 percent would still be possible by encoding the list as six-bit values, but this would also apply to any text which contained few special symbols, numbers or capital letters, not just to dictionaries.

At the other end of the scale, consider the following list obtained from the *Pocket Oxford Dictionary*. Here the compression amounts to 60 percent. Far greater reductions would be achieved if the list included derivations, such as receiver, recently and recessional.

original word	length	compressed word	length
recede	6	0 recede	7
receipt	7	4 ipt	4
receive	7	5 ve	3
recent	6	4 nt	3
receptacle	10	4 ptacle	7
reception	9	6 ion	4
recess	6	4 ss	3
recession	9	6 ion	4
Totals	60		35

The space between the count and the other letters in the compressed words are included for legibility only and would not be stored with the data. The total space occupied by the original list is 68 bytes: 60 letters plus eight delimiters. The total space occupied by the compressed list is just under 27 bytes: 35 multiplied by 6/8. The saving is therefore 60 percent.



(continued from previous page)

all the four-letter English words ending in ZZ, type

Find ???z

and your wish will be granted — there are six of them. The second data-compression algorithm is called run-length encoding, and it again makes use of counts. Consider the following sequence of letters

AAAAARBBSSSSWWWWWWMAAAXIIIII
 Since this sequence contains several strings of repeating characters, you can compress it very easily by replacing each repeated string by a single copy of the letter, together with a count of the number of times — the run length — it appears. The compressed version is therefore

5ARBB4S6WM3AX4IL

But alas, there are very few data structures in which characters obligingly repeat themselves in this way. One limited use might be in text files, where the space characters tend to come together in strings. In fact, the familiar Tab character might be thought of as a special case of run-length encoding.

However, a refined version of the technique is often used for strings of binary digits, 0s and 1s, particularly in the world of bit-mapped graphics. Here you only need to store the counts, not the actual digits, since you know they alternate between 0 and 1.

For example, a digital typesetting machine, like the one used to set the pages

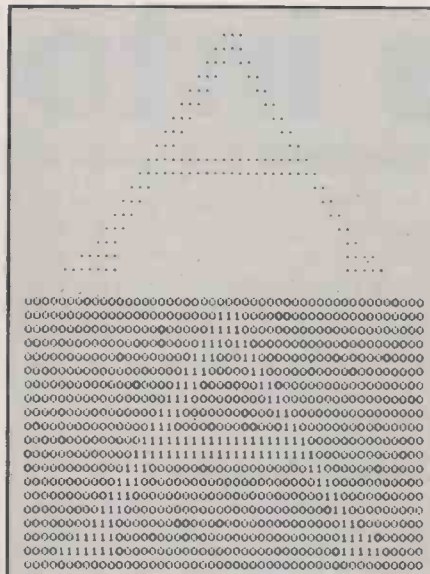

71	3		
44	4		
43	3	1	2
41	3	3	2
39	3	5	2
37	3	7	2
35	3	9	2
33	3	11	2
31	3	13	2
29	20		
27	22		
25	3	19	2
23	3	21	2
21	3	23	2
19	3	25	2
17	3	27	2
14	5	27	4
10	7	27	5
53			

The bit pattern can be represented more compactly by the above counts.

of PC, holds a number of fonts — that is, sets of characters of different styles and sizes. The characters are formed from an array of dots like in a dot-matrix printer except that a much higher resolution is used. In the example shown, the letter A is formed in a 20 by 48 matrix, in which the letter itself is represented by 1s and the white space around it by 0s.

If you apply run-length encoding to this shape you end up with 65 counts. Assuming each count is held in one byte,

the array can be stored in 65 bytes rather than the 120 needed to store it verbatim.

A further saving is possible by using six bits for each count. Where a count exceeds 63, which is the highest value that can be represented by six bits, you can break it into two by inserting a dummy run of the alternate digit, this run being of length zero. In the example, this would cause the first count, 71, to be replaced by 63, 0 and 8. The overall storage required would be cut to 51 bytes.

FORTH = TOTAL CONTROL

FORTH programs are instantly portable across the most popular microprocessors.

FORTH is interactive and 20 times faster than BASIC

FORTH programs are structured, modular, and easy to maintain.

FORTH gives control of all interrupts, memory locations, and I/O ports.

FORTH gives full access to DOS files and functions.

FORTH application programs can be converted to turnkey programs.

FORTH Cross Compilers can generate ROMmable code for: 6502, 6809, 68000, 8080, Z80, 8086, 6800, 6801/3, 1802, Z8, 8070, Z8000, 99xxx, LSI-11

We are the FORTH specialists, we also stock a large range of books, listings, and implementations for machines ranging from Spectrums to VAXes.



MicroProcessor Engineering Ltd

21 Hanley Road, Shirley
 Southampton SO1 5AP
 Tel: 0703 780084



Application Development Systems include FORTH with virtual memory, multi-tasking, assembler, full-screen editor, decompiler, utilities, and full documentation.

Z80 or 8080 FORTH - CPM 2.2 £60

8086 FORTH - CPM-86, MSDOS £105

PC/FORTH - PC/DOS, CPM-86 £105

8086 FORTH- 83 - CPM-86, MSDOS £120

PC/FORTH - 83 PC/DOS, CCPM £120

68000 FORTH - CPM-68K £190

FORTH has 32-bit stacks and directly accesses the whole address space of the processor.

PC FORTH+ £190

8086 FORTH+ £190

68000 FORTH+ £290

Extension Packages include floating point, cross compilers, 8087 support, colour graphics, databases

PRINTER SWITCHES FROM HOMESTEAD ELECTRONICS

LINK TWO OR MORE MICROS TO ONE PRINTER, PLOTTER, MODEM ETC. OR VICE VERSA

- ★ ROBUST CONSTRUCTION
- ★ SCREENED, METAL HOUSING
- ★ FULLY TESTED
- ★ BI-DIRECTIONAL
- ★ NO POWER REQUIRED
- ★ 12 MONTHS GUARANTEE
- ★ OFFICIAL ORDERS ACCEPTED
- ★ 24 HOUR DESPATCH

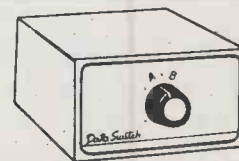

SERIAL DATA SWITCHES

RS 232/V24, 25 way 'D' sockets	
LINES 1 to 8 & 20	
Model R2 2 way switch	£49
Model R3 3 way switch	£57
Model R4 4 way switch	£65
Model R5 5 way switch	£73
Model R8 8 way switch	£110
Model RX 2 way cross-over	£65

ALL 25 LINES	
Model V2 2 way switch	£65
Model V3 3 way switch	£77
Model V4 4 way switch	£89
Model V5 5 way switch	£101
Model VX 2 way cross-over	£89

PARALLEL DATA SWITCHES

CENTRONICS, 36 way sockets	
Model C2 2 way switch	£79
Model C3 3 way switch	£99
Model C4 4 way switch	£119
Model C5 5 way switch	£139
Model CX 2 way cross-over	£119

IBM PC, 25 way 'D' sockets	
Model P2 2 way switch	£65
Model P3 3 way switch	£77
Model PX 2 way cross-over	£89

IEEE-488, 24 way sockets	
Model E2 2 way switch	£89
Model E3 3 way switch	£109
Model EX 2 way cross-over	£129

PLEASE ADD VAT AT 15%. ALL ITEMS CARRIAGE PAID
 TRADE, EDUCATIONAL & EXPORT ENQUIRY WELCOME
 CABLES ALSO AVAILABLE. EX STOCK & CUSTOM BUILT



HOMESTEAD ELECTRONICS

Trelawney Industrial Court
 Trelawney Avenue, Langley
 Slough, Berks. SL3 7UJ.
 Telephone: (0753) 44269

MAKE YOUR XT* MULTI-USER

... and get 1000s of software programs as a bonus.

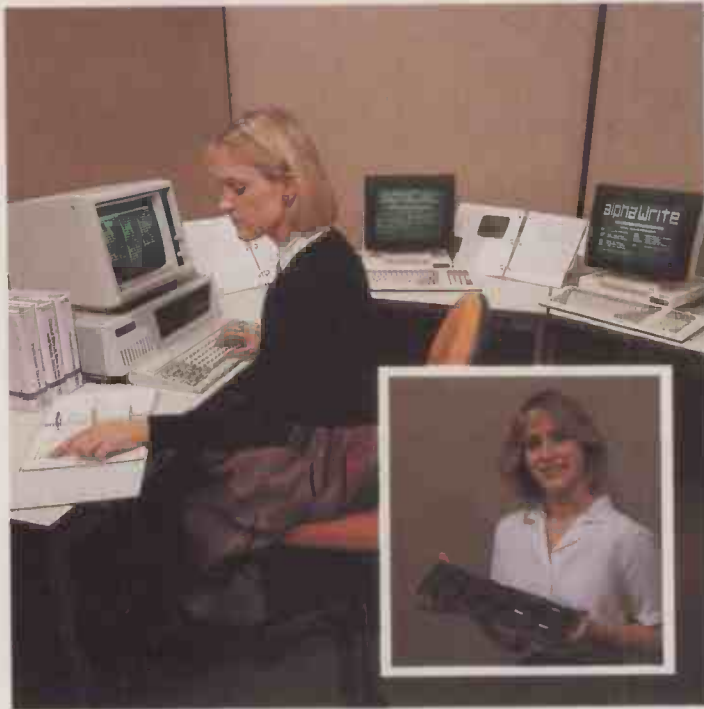

Transform your IBM XT or hard disk lookalike into a multi-user system in minutes.

For £2,400 you get the Motorola 68000-based AM170 board which upgrades your micro to a three-user system, plus Alpha Micro's AMOS multi-user and multi-tasking operating system. Your system now has the dual ability to operate as a multi-user system under AMOS or a single-user system under MS/DOS.

You can switch files between operating systems so that, for example, text created in an AMOS program can be used directly by a program running under MS/DOS, and vice versa.

Most importantly you can use the many thousands of software packages written for the IBM PC, as well as the proven multi-user business software that runs under AMOS.

And if you don't have a PC to start with, Alpha Micro can supply a full Entry Level System for this dual capability for under £5,800. Then when you are ready you can upgrade to compatible systems for 40 users.

ALPHA MICRO COMPUTER SYSTEMS

Call Alpha Micro for your nearest dealer.
Alpha Microsystems (GB) Ltd, Berkshire House, 56 Herschel Street,
Slough, Berks. SL1 1PY. Tel: (0753) 821922.

*XT is a registered trade mark of IBM Corporation

● Circle No. 148

PEGASUS ACCOUNTING

Regarded by many accountants as the very best accounting software available. Pegasus comprises eight modules, most of which will operate alone or will work together in a totally integrated system. We have professional staff, in London and the Midlands, fully trained to install and support Pegasus. Prices and details on request.

PSION XCHANGE

Now, for the first time, you can buy a modular suite of programs that individually represent the latest state of development in word processing, data management, financial planning and graphics. Linked together they form an integrated software system that allows you to switch instantly between various tasks and to exchange information between programs. This exciting new software development from the British company Psion is priced at:

£495 £399

Individual module prices are available on request. Psion Xchange is currently available on IBM, Apricot and Sirius.

COMPUTER BOOKS

We sell a range of over 200 books. Included in the titles we sell are: "Getting to know your Apricot" £12.95, "dBase II for the First-Time User" £13.95, "MS DOS User's Guide" £11.05. Please ask for a copy of our booklist.

CHIT-CHAT

The new telecommunications package from Sagesoft which we feel represents outstanding value for money.

- Micro-to-micro file transfer.
 - Top of the range EMI Datatek modem.
 - Free subscription to Telecom Gold (worth £100).
 - Access to Viewdata and Prestel.
 - Electronic mail, telecommunications and telex.
- List price £399 our price £325.

BEST UK SOFTWARE PRICES?

Buy from TriSoft Ltd., the specialist software company, formed by microcomputer consultants.

- * Over 400 leading software packages (inc. Apple)
- * Independent advice in making your choice
- * Professional staff + network of consultants
- * Most formats. All programs latest versions

SPECIAL OFFERS

DBASE II £229
WORDSTAR PROFESSIONAL £265

	List Price	Our Price		List Price	Our Price
SAGE PLUS	695	495	SAGE PAYROLL	195	139
SYMPHONY	550	415	DMS DELTA 2	495	375
OPEN ACCESS	450	310	DR C COMPILER	275	218
QUICKCODE	200	149	DR ASSEM. + TOOLS	155	119
SUPERCALC III	295	199	DISPLAY MANAGER	375	299
DATAPLOT +	195	155	MS PASCAL	250	199
INFOTAR	295	218	VISICALC	207	175
MULTIPLAN	179	135	STATPACK	345	299
MS WORD	300	239	DGRAPH	200	145
WORDCRAFT	425	359	DR DRAW	232	179
VOLKSWR DEL.	295	199	GRAPH PLAN	220	175
MULTIMATE	350	229	BSTAM	145	110
SPELLBINDER	320	220	CROSSTALK XVI	140	119
FASTPLAN II	525	395	MOVE IT	90	79
PLANSTAR	495	375	THE LAST ONE	330	245
CARDBOX	195	169	OMNIS 2	295	235
RESCUE	295	229	SUPERSORT	145	108
MILESTONE	250	179	FILE TRANSFER	95	79

SAGE ACCOUNTS £259

The new updated version (1.5) featuring many of the enhancements at only £259 (reduced from £375). Please telephone or write for details of all other Sage Accounting products and our Sage training programme.

All prices exclude V.A.T. POST FREE on orders over £150. If you see any of these products advertised at a lower price we will improve upon that offer in most cases. Please phone or write for our comprehensive price list.

DEALER AND CONSULTANT ENQUIRIES WELCOME

TRISOFT LTD

INDEPENDENT MAIL ORDER DISTRIBUTORS OF QUALITY SOFTWARE
Castle House, Lea, Matlock, Derbyshire DE4 5GL. Telephone: 062 984 383/719

HARDWARE

We supply the full range of Apricot and Sirius computers and a wide range of printers, plotters and peripheral equipment. Please telephone or write for our latest prices.

COMPUTER-AIDED DESIGN

As specialist consultants in this field we can supply either software only or a total system configuration with full support. We are suppliers of AUTOCAD, DODDLE and a number of other CAD packages. The productivity benefits of CAD are enormous — the cost of a system is almost certainly much less than you would expect. In most cases our clients have found a system pays for itself within 3 to 12 months! For example, an Apricot xi10 with 9" monitor, the exciting new CAD package Doodle and a Roland DG XY880 plotter (high quality, high speed, HP compatible, eight pen) will cost only £3750.00. Although this price represents an attractive discount on list price, it includes full technical support by our specialist staff.

SYCERO

System C's program generator which sets a new standard for ease of use in system design for the businessman as well as the computer professional. Allows very rapid development and implementation of systems which precisely meet your requirements. A top quality product which we highly recommend.
List price £595 Our price £495

NORTH STAR DIMENSION

The only 100% PC-compatible multi-user, multi-processing system currently available. Will accept up to 12 work stations and runs all IBM "off-the-shelf" software. Tremendously cost-effective as compared to IBM PC networks; up to 60MB central storage. Entry-level, 2 screen configuration with 15MB central storage — only £5875.

Modem WS 2000: why it's the experts' choice.

You don't need to be told about the information revolution – you already know that without efficient data communications, you and your business may not survive it.

And you know that a modem will be a vital part of your survival kit.

This is why you should choose Modem WS2000 from Miracle Technology.

✦ **Quality** – In concept and construction Miracle Technology sets the standards other modem manufacturers aim for.

Quite simply, WS2000 is one of the best designed, best made modems you can buy.

It is approved for PTT use in the UK and Holland, with approval pending in other European countries.

✦ **Flexibility** – As a multi-speed, multi-standard modem, WS2000 enables data transfer between almost any two computers – world-wide.

WS2000 gives instant access to the vital information sources of Prestel, Micronet, Telecom Gold and a vast range of public and private databases.

WS2000 can also convert your computer to a telex terminal, giving you inexpensive 2-way international telex facilities.

WS2000 is suitable for use with a wider range of computers than virtually any other modem, and we can offer software packages for most makes.

✦ **Versatility** – No other modem offers all the facilities available with WS2000.

Its unique versatility means it can be expanded by the addition of autodial and autoanswer options (presently undergoing approval testing with BABT), plus direct computer software control of the modem and much more.

✦ **Service** – A large dealer/distributor network both in the UK and abroad means you're never far from a WS2000 stockist.

And our Customer Service and Technical Departments are happy to give help and advice.

✦ **The Experts** – Thousands of users depend on WS2000 – local authorities, government departments, multi-nationals,

private companies and individuals.

WS2000 is the modem chosen by the BBC to demonstrate a UK-USA datalink live on TV; selected by Cable & Wireless/Western Union for their Easylink Telex Service; taken

round the world on Operation Raleigh; in action for CBS News, sending front-line war reports around the world.

WS2000 is the modem used by people who need reliable data communications today – and every day.

WS2000, with BT telephone lead, mains power supply and comprehensive operating manual costs only £129.95 exc. (£154.73 inc. VAT & UK delivery) – you may also need a computer lead (£10.35 inc.) – specify computer when ordering.

A small price to pay for survival.

Order by cheque/Visa/Access/Trade or official order to:

✦ Miracle Technology (UK) Ltd,
St Peters Street, Ipswich IP1 1XB.
☎ 0473 50304 ☐ 946240 CWEASY G 19002985

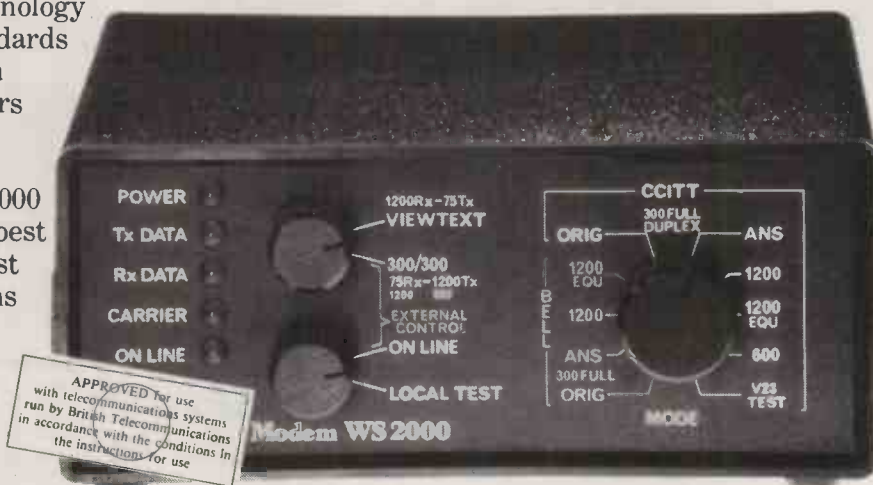

MIRACLE TECHNOLOGY
we thought of tomorrow, yesterday.

TABS

Business Centres



One stop.



The ACT Apricot. £21.30 per week + VAT over a 36 month rental period with a TABS RENTAL CARD.

Available from your nearest Business Centre or TABS Ltd, Dolphin House, New Street, Salisbury, Wilts. Tel: 0722-338668



THE FIRST CHOICE—THE FINAL ANSWER

... its still

FOLLY MICRO



PRINTERS

BEST EVER PRICES

CANON PW 1080A £319 + VAT
 SHINWA CP80..... £169 + VAT
 THE NEW SHINWA CPA 100CPS..... £195 + VAT
 DAISYSTEP 2000..... £195 + VAT
 MP 165 A new standard for dmp..... £299 + VAT
 80 Col. 165CPS with an INCREDIBLE 75N.L.Q.

SEIKOSHA GP50A..... £95 + VAT
 SEIKOSHA GP100P or S..... £143 + VAT
 SEIKOSHA GP100VIC..... £175 + VAT
 SEIKOSHA GP500A..... £175 + VAT
 SEIKOSHA GP250X..... £199 + VAT
 SEIKOSHA GP700A..... £347 + VAT

STOP PRESS

JUKI 6100

JUKI 6300

BARGAIN PRICES

The NEW JUKI 6300 ultimate daisywheel £199 + VAT
 Bestseller JUKI 6100 still available for just £326 + VAT
 JUKI prices include Cable, Paper and FREE delivery

PRINTER SUNDRIES & SUPPLIES

**RIBBONS; PRINTWHEELS;
 ALL MAKES SENT BY POST**
**CABLES; INTERFACES;
 QL to Centronics £28 + VAT**
ALL MAKES AVAILABLE
RING FOR DETAILS

BUSINESS SOFTWARE

Lotus 123..... £295 + VAT
 Symphony..... £425 + VAT
 Compsort Delta..... £495 + VAT

MODEMS BT APPROVED

Minimo 300 baud £96 + VAT
 Minimo 300/1200/75 baud..... £145 + VAT

EVEN MORE PRINTER BARGAINS

STAR GEMINI 10X..... £185 + VAT
 STAR GEMINI 15X..... £270 + VAT
 STAR DELTA 10..... £298 + VAT
 STAR DELTA 15..... £380 + VAT
 STAR RADIX 10..... £390 + VAT
 STAR RADIX 15..... £477 + VAT

MANNESMANN TALLY

MT 80..... £173 + VAT
 MT 160..... £449 + VAT
 MT 180..... £579 + VAT
 PIXY PLOTTER..... £495 + VAT
 With FREE IBM, BBC or APPLE SOFTWARE

PRIORITY ORDER

Please send me:

 Name _____
 Address _____

I enclose cheque/PO for £ _____

Please add VAT + £9.50 DLY PER ITEM

PC4/85

FOLLY MICRO



0730 894078

0730 67057

10 College Street, Petersfield, Hampshire
 9am-9pm every day or send SAE for full range

We have no connection with any other retailer

SHOWROOM NOW OPEN

MICROSURE INSURANCE IS CHEAPER THAN MAINTENANCE CONTRACTS

Insurance against Breakdown and other causes of loss or damage to Micros, Word-Processors and other Hardware, and including Software, Data Reinstatement and Increased Costs of Working can cost

UNDER 2%

of the values insured. There is no requirement for a Maintenance Contract to be in force.

For a quotation Request Form telephone

**BOLTON INSURANCE
SERVICES LTD**

on 01-736 9725
or 01-628 0898

● Circle No. 156

**JUST £395^{+VAT} BRINGS
ALL THE ACCOUNTS ALIVE**

On the IBM PC, IBM PC XT, IIT Xtra, Sirius, Apricot, Dec Rainbow, NCR Decision Mate, Wang Professional, Apple II & III, Samurati, Hitachi, Rair, all IBM think alikes, Osborne, ICL DRS & ICL PC; in fact most CPM and MS-DOS 2 floppy disk drive or hard disk machines.

Complete, sophisticated, fully screen menu driven, single entry integrated accounts program. Fast operation, easy to use. No complicated configuring or file structuring. No hidden extra expensive module costs.

package comprises of:

SALES LEDGER: Full transactional automatic posting, invoices, credits, payments, adjustments, vat 99 sales analysis codes, 99 customer analysis codes. Printed audit trail. Anytime printed reports include Debtor listing, statements, sales, customer analysis & vat reports. Letter/Report writer & Label Producer. Rapid screen enquiry facility.

PURCHASE LEDGER: Full transactional automatic posting, invoices, credits, payments, adjustments, vat 99 purchase analysis codes. Printed audit trail. Anytime printed reports include creditor listing, statements, purchase analysis and vat reports. Rapid screen enquiry facility.

NOMINAL LEDGER: Analyse the business completely. Anytime printed reports include one page Operating Profit Statement; Trial balance, net & gross vat report. Sales Purchase Analysis Nominal codes. Detailed sales analysis by product & customer type. Budget analysis inc % variables. Rapid screen enquiry facility.

STOCK CONTROL: Automatic adjustment. Receive, issue and adjust levels. Printed audit trail. 3 decimal place pricing. Anytime printed reports include Reorder list, usage, valuation, suppliers, cost of sales; Recommended Selling Price List. Rapid screen enquiry facility. 3 type unit price stock valuation.

INVOICING: Immaculately produced sales invoices on plain or headed paper linked to stock & sales ledger. Invoice message facility. Automatic line entry. Purchase invoice posting and stock pricing.

INTEGRATED OR NON-INTEGRATED OPTIONS

EXPANDABLE. TRIED AND PROVEN IN 100'S OF SITES IN UK & OVERSEAS.
FULL AFTER SALES SUPPORT. FULLY GUARANTEED. NO HIDDEN EXTRAS.

TOTAL PRICE INC. VAT £454.25

cheques made payable to DATA MARKETING LTD.

**EASY TO USE INTEGRATED ACCOUNTS from
DATA MARKETING LIMITED**

Maxet House, Liverpool Road, Luton, Beds. LU1 1RS, U.K.
Tel: (0582) 456869 & 458806. Telex: 827549
DEALER & EXPORT ENQUIRIES WELCOMED

● Circle No. 144

PRACTICAL COMPUTING April 1985

>NEXT MONTH

>MONEY PROGRAMS

Micros have an important role to play in financial management. In next month's special section we look at various ways they can contribute, from handling cash to accessing on-line financial services such as stock prices and BACS. We also explain in detail how to choose an accounts program.

>REVIEWS

The Sprite is claimed, by its manufacturer, to be the fastest micro in existence. We will be taking a look at Jarogate's new baby to see if it measures up to its promise. Also on the test bench is Athena, an IBM PC compatible micro better known as the Canon A-200.

CP/M for £500? Only a couple of years ago a 64K CP/M micro with a monitor would cost around £2,000. Now Amstrad is delivering disc drives and CP/M for its £239 micro, and we see how well it performs.

>AND MUCH MORE...

A micro can be used to produce titles for video films or slides. Next month the techniques are explained by Paul Kelly of the Television Literacy Project, with a listing for the BBC Micro. In our regular CP/M slot, we explain how to turn your CP/M system into a typewriter.

Our usual line-up of columns will provide lots of practical information and Sound Advice — taken literally by Mike Lewis in Software Workshop. Plus our expanded news section will tell you what is going on in the world of microcomputing.

Don't miss the May issue of the new look

PRACTICAL COMPUTING

On sale at W H Smith and all good newsagents
after April 17.

Contents may vary due to circumstances beyond our control and are subject to change without notice.

**WHO'S
PUSHING UP
DAISIES NOW?**

The daisy-wheel printer as the only machine for letter quality printing is DEAD!



TOSHIBA 1351

No Daisy-wheel can match the dazzling speed of the 1351 Multi-Mode Printers at 100 cps in letter quality nor can it offer high resolution graphics. Without a physical change of print-wheel no Daisy Printer can mix text styles in a document *so important for highlighting those important points* and custom character sets are a virtual impossibility.

All these features plus high quality draft printing at 200 cps are available on the 1351, so send for a print sample and see how dead the Daisy-wheel Printer really is.

SEE THE TOSHIBA 1351 AT:

Company	Town	Phone
COMPUTER SERVICES SCOTLAND	GLENROTHES	0592 773710
VUMAN	MANCHESTER	061 273 5315
JOHNSON MICRO-COMPUTERS	CAMBERLEY	0276 20446
ESSEX COMPUTER CENTRE	CHELMSFORD	0245 358702
NEXEL	BRISTOL	0272 214071
NEXEL	EDINBURGH	031 339 1300
NEXEL	LEEDS	0532 461151
NEXEL	MANCHESTER	061 799 1333
NEXEL	BIRMINGHAM	021 550 4717
NEXEL	WALTHAM CROSS	0992 767010
NEXEL	LONDON	01 580 8203
ADACS	ANDOVER	0264 59255
LION HOUSE RETAIL	LONDON W1	01 580 7383
DIGITUS	LONDON WC2	01 379 6968
WEST SURREY COMPUTERS	WOKING	04867 88561
PERSONAL COMPUTER CONNECTION	PORTSMOUTH	0329 230870
AMBIS	LONDON W1	01 434 4251
MICROGENERAL	READING	07357 4466
SOUTH WALES PERIPHERALS	NEWPORT	0633 841760
DANETRE BUSINESS SYSTEMS	NORTHAMPTON	0604 36231
BMS	DUBLIN	0001 523 142
C.I.C.	LETCHWORTH	04626 79466
FRASER ASSOCIATES LTD.	BUCKINGHAM	0280 816087
CINLORD	POTTERS BAR	0707 56348

CUT ALONG DOTTED LINE

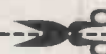

**DAISY-WHEEL
PRINTER
R.I.P.**

Please send to:-
THAME SYSTEMS LTD., THAME PARK ROAD, THAME,
OXON OX9 3XD for a print sample to see how obsolete
the Daisy-Wheel really is.

NAME _____

COMPANY _____

ADDRESS _____

THAME SYSTEMS LTD.
PERIPHERALS DIVISION
THAME, OXON OX9 3XD TELEPHONE: 084 421 5471 TELEX: 837508

A Member of the Memec (Memory and Electronic Components) PLC Group

NORTHERN OFFICE: WARRINGTON (0925) 825065

G. W. COMPUTERS LTD

London's West End — Nationwide overnite service — More product ranges —
Probably the widest selection of networks/micros/and printers

WE OFFER ONE OF THE BEST 'SYSTEM DEALS' IN THE U.K. (save 1500.00 +)
THE NEW DBMS III.7 (series III of the world's first 'task-robot-programs')

G.W. COMPUTERS LTD — Tel: 01-631-4818

Mbasic & word-star compatible
1400 character record sizes
mathematical scratchpad,
record relational indexes,
translatable to any language
User-definable reporting
field protection/classification,
either-or, same as, greater, smaller
sorts alpha/numeric any window
12 online file architectures.
240 fields using cross-referencing
cross-record calculations.
'Jump-to' any record in 12 files.
User-define files/field words/sizes.

....FEATURES....

32000 records per filename
20 main/200 sub fields per record, field
and record related formulae.
'Jump-to' any of 3200 records per file.
random/binary/key/multiple field
search. 'if-then' questioning
file protection/password entry.
range match, not match, integer match.
sort speed 500 records per 20 seconds
endless 'either-or' matching
formulae/recall on selection criteria.
13 interrogation question types
short filing output/audit trails.
'sale-mail-shots'; 'production-process-
'purchase/sales-analysis'; 'personnel-file'

DBMS III 7 new switch mode facility enables you to cross up to 12 different files (32000 records per file) pre-selecting any of up to 20 fields per record/file for display/print output (240 fields) in all. One massive enquiry can pass through 384,000 records

You might have two files whose records are directly related to each other, so that the first file (say containing names and addresses) refers to the second file (say financial and other information relating to the same record numbers in the first file) directly. Then you can simply choose that in file 1 you are interested in just the name and telephone numbers, whereas in file two, you are interested in the income, trading period and number of branches. Information. Your enquiry can then pass through both files highlighting that information only. Actually there doesn't need to be a strict correlation between the same record numbers in different files, and you can also just on JUMP command go to any record in any of the 32000 records in any one of the twelve files and carry on cross-referencing from there onwards

DBMS'S MACROS WORK FROM THE MOMENT YOU INSERT THE 'TASK DISK' IN THE COMPUTER

Simply design your file, give its fields your words, set up your report mask, and then enter your records. Switch to 'automatic drive' and formulate any task you wish the program to fulfill, the task is stored as a macro. Take a copy of the program on another 'task disk' and from then on, the task disc will function without a single key-stroke. Think of a number of such 'task disks' such as "stock-re-order reports", "stock-valuation reports", analysis, "patient history analysis", "research-analysis", "budgeting", "plus more?"

Not only does this program surpass most of its kind that you might buy elsewhere, but if you buy the hardware from us, then you get it — FREE ... DBMS II (WITHOUT MACROS) AND DBMS III ARE FULLY IMPLEMENTED UNDER CPM-86 (tm) AND MS-DOS (tm) ie: < SIRIUS/VICTOR/IBM > DBMS II IS 395.00 (or 250.00 by mail order ex. training). DBMS II IS 575.00 (or 295.00 by mail order ex. training).

Contains the highest state of the art software available today

FORMS/TEXT/CALC/DBMS IV — ALL IN ONE PROGRAM THE —"KEY" — @ 575.00.

When you budget for a complete system of software you eventually end up with a host of packages like, Sales, Purchases, Nominal Data, Text, Calc, Mailshot, Invoice, Order, Workflow, Personnel, and so on. The list is endless and the outlay several thousands of pounds.

Features Design a form as wide as a window of 250 characters, long as needed. Cursor movements are 'left, right, up, down, delete left, delete right, tab right-left-up-down'. Paint your form as you like directly on the screen.

Text. Write a letter as you see it on the screen, edit it then simply enter P to print. Calc. Set into the form, your data fields, "#####" and specific file-related activities, formulae and validation checks. Enter values and see the spreadsheet calculate itself.

Database. Search files for data to be inserted to fields specified. All the features of DBMS III, explained elsewhere in our ad.

Here's an example of an Invoice you might design for your stationery ... You could design your own spreadsheet, order form, statement, wage docket, or any other kind of form that is required to fill your existing stationery.

INVOICE				
To <1> #####	From: G. W. Ltd			
<2> #####	55 Bedford Court Mans.			
<3> #####	Bedford Avenue			
<4> #####	London W.C.1			
<5> #####	Tel: 01-636-8210			
Date <6> ##,##	Tax point <7> ##,##	Agent <8> ###		
Quantity	Description	Cost	Tax	Total
<9> ##	<10> #####	<11> ##	<12> ##	<13> ##
<14> ##	<15> #####	<16> ##	<17> ##	<18> ##
Total ... <19> #####		Tax ... <20> ###		

and so on

<??> Items <1> to <5> internal command to request name, input, and then search an address file for details.

<??> Items <6> to <7> request date input and validate.

<??> Item <8> request agent number and validate range.

<??> Item <9> request quantity, validate range.

<??> Item <10> request description, search file, accept, and calculate fields <11> <12> <13>, if finished invoice then calculate fields <19> and <20>

Now comes the more valuable facility. You can provide the 'FORM' with file-related instructions, not only to request a 'console' input for file search against names, and stock, but after the invoice is finished, the fields you have selected may be passed to related files.

EG: Send fields <0>, <1>, <06>, <07>, <11>, <12>, <13>, <19>, <20>, to a sales ledger.

Then send fields <9>, <10>, <11> to product analysis file.

Then send fields <0>, <1>, <7>, <19>, <20> to V.A.T. file.

Then send fields <10>, <11>, <12>, <13> to Nominal ledger. Do you see?

G. W. COMPUTERS LTD — Tel: 01-631 4818

SYSTEM DEAL (our speciality) SAVES YOU 1500.00+

Buy any computer, any printer and 150.00 value diskettes add 85.00 for cables and testing. Add 10% for return to base warranty for 1 year (optional) add 110.00 for delivery & installation (optional) training optional extra 120.00

and get completely ***** FREE *****

cpm handbook.....50 basic exercises.....2000 sheets paper
DBMS III.7.....wordprocessing.....spreadsheet
mbasic.....diagnostics.....msort/dsort
recovery.....autoload.....instant basic
library boxes.....disk/games.....DT/AS/NS sorts

***** total value 1400 + + *****

Here's a typical example of a complete system deal

1 — TEXAS instruments pc w/256k ram/2 drives	2445.00
2 — Oki 82a or Epson rx80 printer	295.00
3 — Cables & testing	85.00
4 — Diskettes	150.00

software described above ————— FREE —————
2975.00

We specialise in 'STANDARD MICRO-PRINTER SYSTEMS' as well as 'NETWORK SYSTEMS BASED ON A SHARED HARD DISK'.

The range of computer products (mostly ex stock) includes the most popular brands of micro-computers, printers, modems, buffers, spoolers and software.

G. W. COMPUTERS LTD — Tel: 01-636 8210

POPULAR BRANDS OF EQUIPMENT WE SELL

MICROS — Texas/I.B.M./Dec/Superbrain/Compustar
— Apple/Lisa/Compaq/Corona.
PRINTERS — Nec/Queme/Diablo/Oki/Epson/Olympia/Ricoh
— Texas/Dre/Anadex/Brother.
OTHERS — Corvus/Compustar/Sigma.
— Hard disks networks and multiplexors
— Spoolers/Modems/Buffers
MAIN AGENTS ————— for TEXAS and MOTOROLA

TERMS & ETC

G.W. Computers Ltd (Grama (Winter) Ltd)
43/55 Bedford Court Mansions
Bedford Avenue
London W.C.1 England
Telex 892031 TWC G

Telephones:
01 636 8210
01 631 4818

Boston office tlx 94 0890

24 hour answerphones; leave address for 'infopacks'. We do not operate a reader's reply card service. Terms: C.W.O. or C.O.D. Prices exclude V.A.T., but include all non-credit discounts available. No dealers! The above lists are not exhaustive. Please call at our showroom only by prior appointment. Unless expressly agreed, all warranties are commercial 90 days return to base for parts and labour. Annual warranties and maintenance facilities available nationwide through closely related third parties.



Tailored Business Systems

Complete Business Systems Tailored To Your Needs
based on Apricot, Sperry, IBM, Hewlett Packard, Sirius, Canon, Epson & Brother

FREE

• System 1 •
APRICOT XI
 Hard Disk + Free Printer +
 Free Integrated Accounts
 Software including Payroll
 Training & Installation
 ★ **£2995** + VAT

• System 2 •
SPERRY
 MODEL 40
 10 MEGABYTE
 HARD DISK
 ★ Free Printer ★
 ★ Free Integrated
 Accounts Package ★
 ★ **£3295** + VAT

initial TRAINING
given with each
system supplied

• System 4 •
SPERRY
 MODEL 25
 COLOUR MONITOR
 360K Twin Drive
 ★ Free
 Integrated
 Accounts
 Package ★
£2450 + VAT

• System 3 •
APRICOT F1
 720K Disk 256K Memory
 includes Integrated Accounts Software
 or Printer ★ **£1495** + VAT



• System 5 •
**APRICOT
TWIN DISK**
 + Free Word Processor
 + Free Printer
 ★ **£1795** + VAT

• System 6 •
IBM XT
 Hard Disk +
 Full Integrated
 Accounts Package
 including Payroll
 + Free Printer
 ★ **£4290** + VAT

• System 7 •
**APRICOT
POINT 7**
 with up to 6
 Terminals & *Integrity*
 Multi User Accounts
 Package
 From
 ★ **£3995** + VAT
*Depending on number
 of Terminals*

• System 8 •
APRICOT POINT 32
 with up to 32
 Terminals including
Integrity Multi User
 Accounting Software
 From
 ★ **£3995** + VAT
*Depending on number
 of Terminals*

■ **Authorised ACT & SPERRY Dealers** ■

Full Maintenance available ■ Leasing Facilities arranged



Tailored Business Systems Ltd

2nd Floor, Gate House, The High, Harlow, Essex CM20 1LW

CONTACT US ON... **0279 413893** (10 lines)

Everyone's saying it's a Great Little Printer!

Now you can afford high quality printing on plain paper, even with the simplest microcomputer system.

- * Full IBM-PC compatibility
- * Nine-pin print head * Original plus two copies * 80-132 columns at 10-17 cpi
- * Optional NLQ printing with 18 x 23 matrix * 50 cps draft speed
- * 48 international characters
- * Optional tractors * High-resolution pin-addressable graphics
- * Light and compact

The New Centronics GLP



'Fantastic value – even my students can afford it!'



'Near letter quality on plain paper – ideal for correspondence!'



'Weight only 3 kg – I can take it anywhere!'

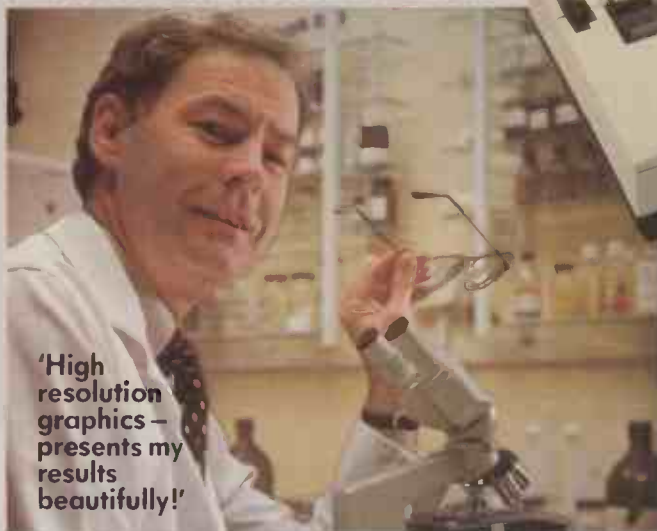

'High resolution graphics – presents my results beautifully!'



Please send full details on the GLP and the address of my nearest distributor

● Circle No. 186

Name

Position

Organisation

Address

PC 4

CENTRONICS

MORE THAN JUST AN INTERFACE

Centronics Data Computer (UK) Ltd Petersham House
Harrington Road London SW7 3HA Tel: 01-581-1011

NEW COMPUTING TITLES FROM CHAPMAN AND HALL

Which Peripherals?

**How to choose them,
how to use them**

PIERS LETCHER

This book will help you to find out just what your needs are and how best to fulfil them. It will save you time and money spent in fruitless sifting through dealers lists. The book gives a comprehensive guide to what is available, which add-on works with which micro; what to look for and where to go when buying peripherals for your micro.

February 1985 180 pages
Paperback 0 412 26510 9 £5.95

Expert Systems

Principles and case studies

Edited by RICHARD S. FORSYTH

This book explains the concepts behind expert systems to readers who know about computing but are unfamiliar with the latest research and with what they can do themselves in building and using expert systems. An expert system is a software package which encapsulates specialist knowledge about a particular area of expertise and is capable of making intelligent decisions within that area. Expert Systems are now used in medical diagnosis, geology, organic chemistry and computer fault-finding, as their range of application is growing daily.

October 1984 200 pages
Hardback 0 412 26270 3 £20.00
Paperback 0 412 26280 1 £9.95

Third Edition

Apple Macintosh Encyclopedia

GARY PHILLIPS and DONALD SCCELLATO

The Apple Macintosh Encyclopedia is an indispensable guide and directory to the enormously successful Apple Macintosh microcomputer, its mode of operation, as well as the software and add-ons now available. Much of the information in the entries is not contained in the Macintosh manuals or in the manuals accompanying special software products.

February 1985 400 pages
Paperback 0 412 00671 5 £12.95

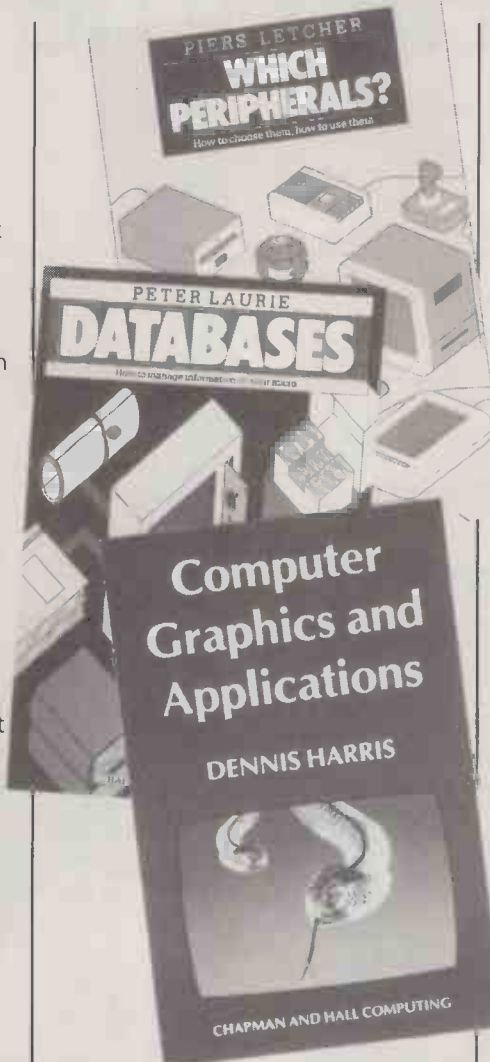

Computer Graphics and Applications

D. P. HARRIS

The book is for students of computing and computer science, for computer professionals wanting a quick introduction to the field, and for any serious user of microcomputers who wants to develop its graphic capabilities.

It begins by familiarising the reader with the graphics hardware equipment currently available. It then describes basic 2-D and 3-D software techniques and examines the growth and diversity of graphics software throughout the industry.

August 1984 200 pages
Hardback 0 412 25080 2 £20.00
Paperback 0 412 25090 X £9.95

Introducing Cal

**A practical guide to writing
computer-assisted learning programs**

KEITH HUDSON

Introducing CAL is a comprehensive primer on the writing of educational software for the microcomputer. It is the only book yet published to combine a practical guide to writing Computer Assisted Learning programs with a theory of human learning.

November 1984 200 pages
Hardback 0 412 26230 4 £20.00
Paperback 0 412 26240 1 £9.95

A Practical Guide to Designing Expert Systems

S. M. WEISS and C. A. KULIKOWSKI

This book offers a practical introduction to expert systems and is designed not only for computer programmers but for all those who want to know how expert systems are structured and what they can do. The coverage is restricted to reasonably simple yet effective techniques, and the overall objective is to give readers enough knowledge that will allow them to 'build expert systems that work'.

June 1984 200 pages
Hardback 0 412 26450 1 £15.00

FORTHCOMING

Databases

**How to manage information
on your micro**

PETER LAURIE

Information management is one of the things computers do well. *Databases* explains clearly how information is organised in microcomputers, how the software works and how to get hold of relevant data and keep it up to date.

April 1985 176 pages
Paperback 0 412 26380 7 £8.95

 **Chapman and Hall**
11 New Fetter Lane, London EC4P 4EE.

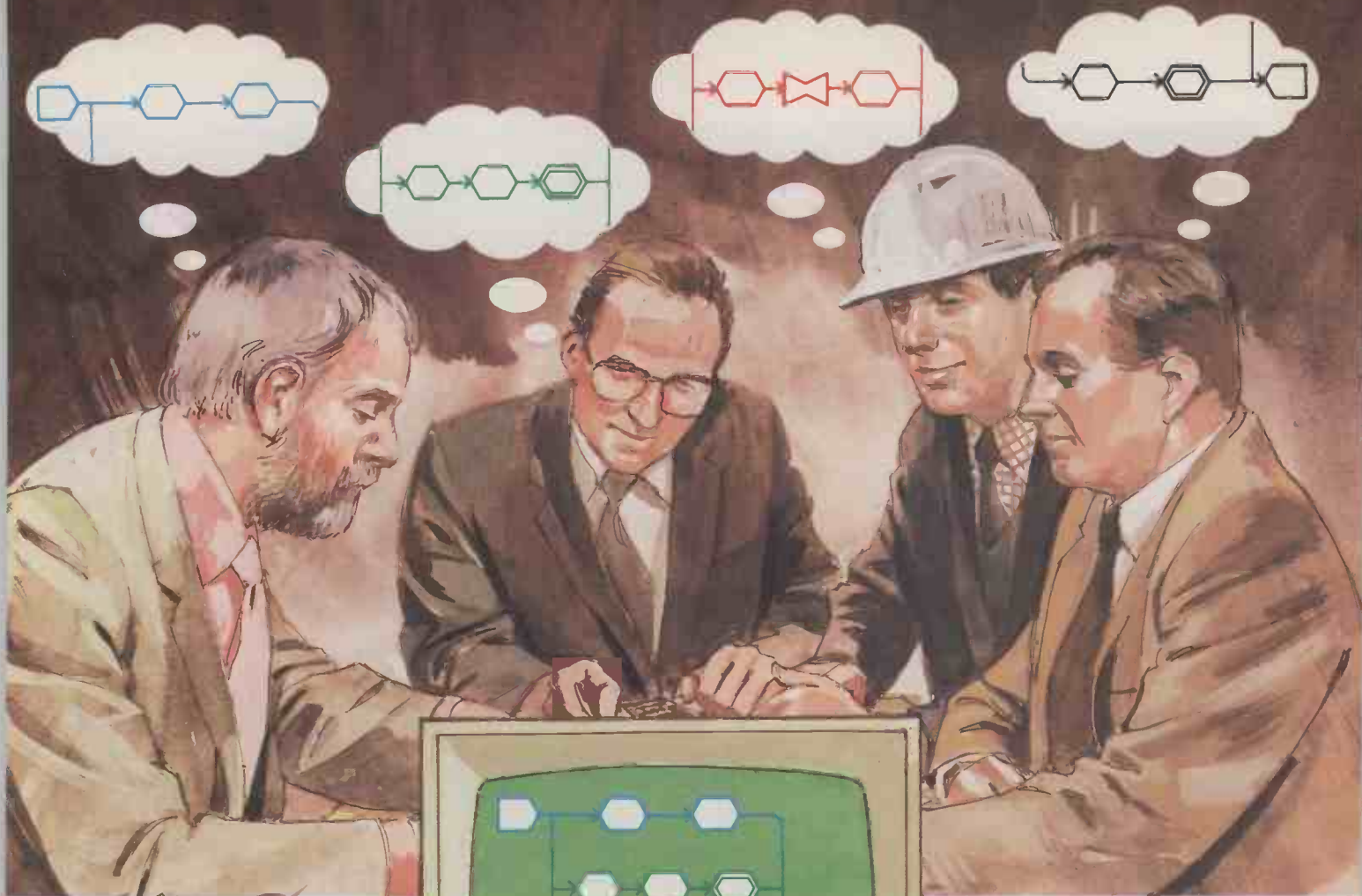

WHEN people put their heads together, it doesn't always mean that they've put their thoughts together.

Planning a project is complex, time-consuming, and difficult to co-ordinate.

What seems clear to you can seem like a brick wall to a colleague.

MICRO PLANNER has the capability to take all aspects of a project, organise them, and present them in a way that makes sense to everybody.

It features the well-known principles of Critical Path Analysis (PERT), and is already used around the world by major engineering, construction, and industrial companies.

In fact it co-ordinates the thoughts

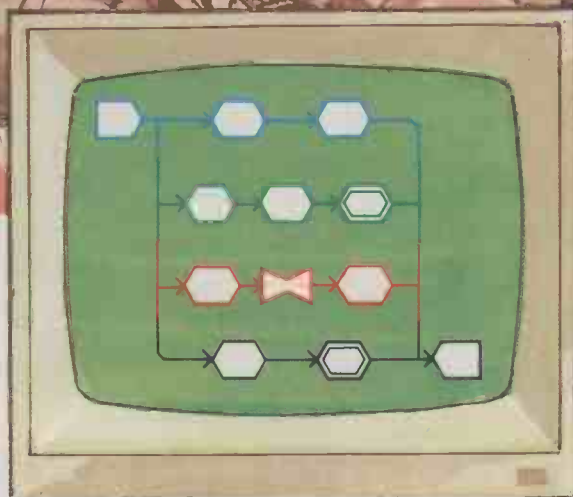

Its flexibility allows you to create project models at will, and to experiment with alternative schedules.

- Features include:
- *Time Analysis
 - *Progress Reporting
 - *Multiple Calendar Scheduling
 - *Labour Control
 - *Resource Analysis
 - *Simulation
 - *Network Plotting.

For further details, and a package including a sample network plot and other outputs contact:

PERFECT PLANNING. CO-ORDINATION OF ALL DEPARTMENTS

of everyone involved in a project, and ensures that the job is completed on schedule and within budget.

MICRO PLANNER runs on most popular microcomputers, including IBM PC, Apple Macintosh, Apple II, Apple III, Sirius, Apricot, Sage, and Corvus Concept.

M | P | S

MICRO PLANNING SOFTWARE LIMITED

34 High Street, Westbury-on-Trym,
Bristol BS9 3DZ, England.
Tel. 0272 509417 Telex 44220 Comtel Ref. 349

Projects flow better with Micro Planner

SS

Looking for a daisywheel?



A quiet word in your ear.

Choosing a daisywheel printer is as easy as you want it to be.

If you're looking for *top letter quality*, consistent performance and long-term reliability, there's no need to go further than the Paper Tiger DP-20 from Dataproducts.

Most important of all, it's a printer that'll be popular with everyone in your office.

Why? Because, it's quiet. The DP-20

operates at less than 55 decibels. That puts it among the *quietest* printers you can buy.

The DP-20 is *fully compatible* with the IBM PC and all other leading makes of micro and comes with a one year warranty.

Whatever your requirements, the world's largest independent printer manufacturer is sure to have the answer.

Call us on
0734 884777



Dataproducts Limited, Unit 1,
Heron Industrial Estate, Spencers Wood,
Reading, Berkshire, RG7 1PJ

Tel: (0734) 884777
Telex: 849227

 **Dataproducts**
Paper Tiger



Q Thank you for your advice in "Ask PC" about how to buy computer parts direct from the U.S., using my credit card. This I have followed exactly, and it works. I now have a different problem in that the software I purchased does not work and I want a refund. How do you suggest I do this?

J Moore

A In the November "Ask PC" we suggested that the easiest way to purchase from abroad was to write and quote your Access — called Mastercard in the U.S. — or Visa credit card number, and its expiry date. The charge for the goods is converted to sterling by the credit-card company and you eventually settle up at the end of the month in the usual way.

We recently returned some defective software to the States, which we had bought using an Access card. By the time we actually received the software, we had already paid the Access bill.

We returned the goods by air mail, together with a letter requesting a credit refund of our money on Mastercard. This is simple to do on credit-card transactions, and the company concerned sent a credit voucher to Access and a copy to us. Our next Access statement should show this sum as a credit entry.

Generally you are not likely to get a refund on software unless the disc is in the wrong format or you can prove it has a serious defect. You should always be able to get a refund on defective hardware. We wish you luck: there are obvious advantages to using a local dealer.

Q I own a Memotech MTX-512 and a Spectrum with Microdrives. I would be grateful if you would tell me if, or how, it might be possible to use the Microdrives with the Memotech.

G Wilcock

A It is most unlikely that you will get the Spectrum Microdrives to work on the Memotech. You have both hardware and software problems to overcome. On the hardware side you have to

ASK PC

construct suitable electronics to drive the Microdrive. On the software side, programs are not stored as ASCII characters, but each line of Basic is converted in its own way, into a mixture of special characters, binary and ASCII. A line of Basic stored on the Spectrum would not be understood by the Memotech.

If you are concerned about storing programs and data on

the Memotech, you will find using a proper floppy-disc unit will offer an unbelievable improvement in speed, reliability and the amount you can store compared with a Microdrive or a cassette. A floppy-disc unit is available for the Memotech RS-128, which is the later model of your MTX-512. Unfortunately, discs are expensive costing around £400.

Cheap WP for the IBM PC

Q I would like to use an IBM PC for serious word-processing, but cannot afford to buy WordStar. I have heard that a word-processing program like WordStar has been written in Basic, and is available quite cheaply. Can you tell me what it is called, how much it costs, and where to get it?

Shaun Milner

A You are probably referring to a word-processing package called My Word, written by Bruce Tonkin. It is sold by TNT Software Inc., 34069 Hainesville Road, Round Lake Il 60073, U.S.A., and also by Roland J Saam at Micros for Managers, 149 Gloucester Road, London SW7 4TH.

The program performs most of the functions of WordStar, and is a full-screen word processor offering the usual cursor movements, wordwrap, search and replace, deleting letters, words, lines or blocks, moving blocks, writing to and reading from files, and so on. It also has a built in mail-merge type of facility. The program was originally written in PBasic, and is sold and used as a compiled Basic program. It runs fast, and when searching through a file or printing it actually operates much faster than WordStar.

An extended version allows columns of figures to be moved, and also allows you to do arithmetic. The standard version costs \$25 and the extended version \$35 — both plus postage — from the U.S. The extended version costs £33.70 including VAT in the U.K. The programs only run on IBM PCs and look-alikes.

We have heard of two other cheap word processors for the IBM. One is called PC-Write, and should be available through the IBM PC Users' Group, or from PC-SIG — as mentioned in the March IBM News section of *Practical Computing*. The other is called the Nutcracker Suite and costs £43 plus VAT. It is available from Lutterworth Software, telephone (04555) 4259.

If you want to transfer Basic programs from one machine to the other, the approach is to list the program to the printer on one machine. Whatever your computer does to Basic internally, it converts it to ASCII characters when you list to the printer. However, instead of having a printer connected you have a wire running into the other machine.

Q I am impressed by the write-up for the Amstrad CPC-464, which seems to be a very cheap method of buying a computer for both games and also more serious tasks. But does this really give access to 3,000 programs as the advertisements say? Their disc drives are 3in. whereas I thought existing CP/M programs were on 5.25in. discs.

C Irvine

A The Amstrad CPC-464 is a very attractive and exciting machine offering a lot of features at a very low price. If you intend to use the computer for playing games you will enjoy the high-resolution colour graphics and the Basic in ROM, and find that the built-in cassette recorder is perfectly adequate for your needs.

To do more serious tasks you do need the £200 disc expansion unit to run CP/M. You are right to be cautious of the claimed access to 3,000 programs, which presumably refers to the number of commercially available programs that run under CP/M-80. You will require these programs to be written in the Amstrad disc format on 3in. discs, and at the moment they are not available in this format.

Amstrad may enter into agreements with the software house and supply programs for its own machine, or some other organisation may make the programs available in the Amstrad disc format. Failing this, you can buy the software on a different format of disc and get a firm like Grey Matter to copy a disc to the new format. If you have access to another computer you can use the program CPM2CPM, given in the January edition of *Practical Computing*, to copy programs from another machine.

PRINTERS

DOT MATRIX

All printers have centronic parallel interface unless otherwise stated. All printers have hi-res dot addressable graphic mode. Please send SAE for full details.

EPSON

FX80 160CPS 10" wide friction & pin feed	£347 + VAT £399
FX100 160 CPS 15" wide friction & tractor feed	£499 + VAT £574
RX80 F/T 100 CPS 10" wide friction & tractor feed	£239 + VAT £275
RX80 100 CPS 10" wide tractor feed	£199 + VAT £229
RX100 F/T 100 CPS friction & tractor feed	£385 + VAT £443
8143 RS 23 Interface for FX and RX printers	£39 + VAT £45
8148 RS 232 Interface with 2K buffer x on x off	£60 + VAT £69
Ribbon Cartridge for RX80 FX80 & MX80	£5 + VAT £6
Ribbon Cartridge for FX100 & MX100	£7 + VAT £8

MP165

165CPS 10" carriage friction and tractor feed	£260 + VAT £299
---	-----------------

SEIKOSHA

BP 420 designed for the business world, 420CPS in draft mode, 110CPS in NLQ mode.	£1095 + VAT £1259
---	-------------------

SMITH CORONA

Fastext 80: 80 col, 80CPS. Friction feed standard	£149 + VAT £171
---	-----------------

TAXAN KAGA

160CPS 10" wide 27CPS NLQ 24 x 16 matrix	£269 + VAT £310
160CPS 15" wide 27CPS NLQ 24 x 16 matrix	£390 + VAT £449

CANON

PW1080A
160CPS NLQ mode, 27CPS, 10" wide friction & tractor feed
£299 + VAT £344

PW1156A
160CPS NLQ mode, 15" wide friction & tractor feed

£399 + VAT £459

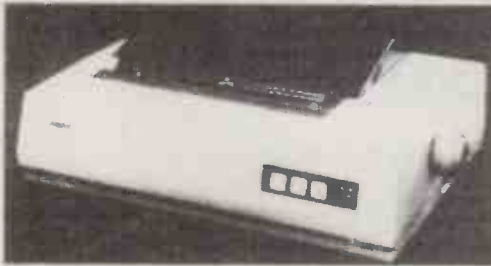

COLOUR PRINTERS

Seikosha GP700A 7 colour 50CPS printer	£299 + VAT £344
Canon PJ1080A 7 colour 40CPS ink jet printer	£433 + VAT £499

DAISYWHEEL

JUKI 6100/I PRINT

20 CPS Bi-Directional Logic seeking 10 12 15 CP1 + PS spacing 2K buffer best selling Daisywheel	£324 + VAT £373
Singer sheet feeder unit	£182 + VAT £209
Tractor Unit	£95 + VAT £109
RS 232 Interface	£52 + VAT £59
Spare Daisywheel	£14 + VAT £16

BROTHER HR-15

13 CPS Bi-directional 10, 12, 15 CP1 + PS	£340 + VAT £399
Keyboard Unit	£139 + VAT £159
Single Sheet Feeder Unit	£217 + VAT £249
Tractor Unit	£95 + VAT £109

QUENDATA

20 CPS Unidirectional 10 12 15 CP1	£239 + VAT £275
------------------------------------	-----------------

All our printers have 1 year warranty

MONITORS

PHILIPS

7001 High Res Green Screen with sond input
£65 + VAT £75

GM1211

GM1211 18 MHZ High Res Monochrome Monitor with tilt and swivel stand available in green or amber etched antiglare screen (please specify colour £86 + VAT £99)

SANYO

DM8112 12" Green screen
18MHZ Hi-Res
£86 + VAT £99

DM9112 Hi Res
Green Screen with
tilt stand
£109 + VAT £126

MICROVITEC CUB

1431 MS 14" RGB Normal Res Colour
£173 + VAT £199

1451 MS 14" RGB Medium Res Colour
£251 + VAT £289

1441 MS 14" RGB High Res Colour
£417 + VAT £479

SANYO COLOUR

Std Res 14" £179 + VAT £206
Med Res 14" £299 + VAT £344
Hi Res 14" £449 + VAT £517

MICROVITEC FOR QL

1451 14" Medium Res Colour.
Specially designed for
Sinclair QL
£239 + VAT £275

ACORN

SANYO MONITOR

SPECIAL

CM 3125

colour monitor

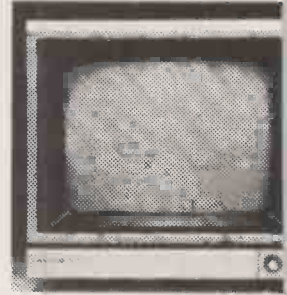

£179 inc VAT

including free monitor stand



COMPUTER GROUP

28/29 BURNT MILL HARLOW, ESSEX CM20 2HU U.K.
Tel. HARLOW (0279) 443521 Telex: 818894 AKHTER G

DISC

100% BBC COMPATIBLE MITSUBISHI AND TEAC SLIMLINE DISK DRIVES

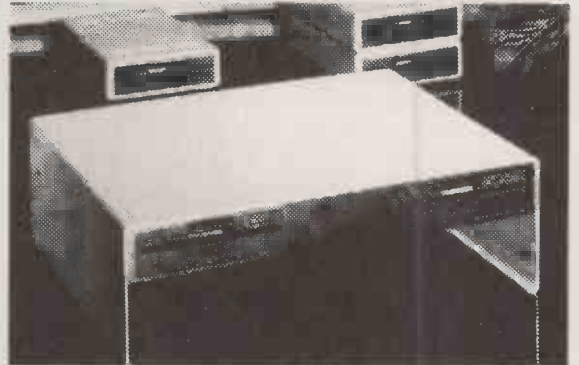

These drives are supplied ready cased with all the necessary cables formatting program and User Guide
There are some very useful utilities included on formatting disc e.g.

- * DISASSEMBLER: This is 6502 machine code disassembler
- * DUP: To copy and rename a file on disc
- * FORMAT: Formatting program for 40 & 80 tracks
- * FREE: This utility provides a disk usage analysis
- * MDUMP: Enables you to display and modify any part of BBC memory
- * MERGE: Merge a number of text files into one file
- * RELOCATE: Downloads a basic program to &E00
- * SDUMP: Screen dump for EPSON In all graphic modes
- * VERIFY: Verifies every sector on a disk
- * MENU: A flexible menu program

PRODUCTS

BBC Microcomputer Model B	£299 + VAT	£344
BBC Mod B - disk interface	£369 + VAT	£425
BBC Mod B - Econet interface	£349 + VAT	£401
BBC Mod B - disk and Econet interfaces	£409 + VAT	£471
BBC Compatible 100K disk drive	£112 + VAT	£129
RBC Compatible dual 800K disk drive	£312 + VAT	£359
Acorn Z80	£347 + VAT	£399
Acorn 6502 Second Processor	£173 + VAT	£199
Acorn Bit stick	£327 + VAT	£375
Acorn IEE Interface	£282 + VAT	£325
Acorn Electron plus 1 Interface	£52 + VAT	£60
BBC Prestel Adaptor	£115 + VAT	£132
BBC Telex receiver (Aug)	£196 + VAT	£225
BBC cassette recorder and lead	£30 + VAT	£35
Disk interface kit (free fitting)	£103 + VAT	£118
Mod A to Mod B upgrade kit	£70 + VAT	£80
Fitting charge for A to B upgrade kit	£20 + VAT	£23
16K memory upgrade kit	£30 + VAT	£34
Games paddles	£17 + VAT	£19
User Guide	£15	
Advanced User Guide	£12.95	
Econet Guide	£ 7.50	
Econet interface (free fitting)	£60 + VAT	£69
Speech interface (free fitting)	£47 + VAT	£54
BBC disk manual - formatting disk	£30 + VAT	£34
Parallel printer cable	£10 + VAT	£11
BBC word processor (view)	£52 + VAT	£59

YOUR CONTACT AT AKHTER Tel: 0279 443521 (12 lines)

DEALER/BULK ENQUIRIES	HAMAYUN MUGHAL	EXT 202
TELEPHONE ORDERS	CARON ANDREWS	210
DEALER ORDERS	JULIA ALLUM	209
EXPORT ENQUIRIES	MOHAMAD EDIB	201
TECHNICAL SUPPORT	ALAN LAFFOLEY	207
ACCOUNTS	JULIE AMBLER	211
LITERATURE REQUEST	JOHN MAULE	201

ORDERING INFORMATION

We accept official orders from UK Government and Education establishments. Carriage is £2.50 + VAT (UK only) for normal delivery. If express delivery is required please add £8.00 + VAT per parcel. We accept telephone orders on Barclay and Access card please ring (0279) 443521 (10 lines). All cheques made payable to "AKHTER INSTRUMENTS".

N. B. All prices are subject to change without notice and are rounded up to the nearest pound

OPENING HOURS: MON-FRI 9am-6.30pm. SAT 10am-5pm.
We welcome callers. no parking problems.

DRIVES

Single drive 100K 40 trks single sided	£86 + VAT	£99
Dual drive 200K 40 trks single sided	£164 + VAT	£189
Single drive 200K 40 trks double sided	£121 + VAT	£139
Dual drive 400K 40 trks double sided	£239 + VAT	£275
Single drive 400K 80 trks double sided	£152 + VAT	£175
Single drive 400K 40 80 trks switchable DS	£155 + VAT	£179
Dual Drive 400K + PSU + built-in monitor stand	£260 + VAT	£299
Dual drive 800K 80 trks double sided	£303 + VAT	£349
Dual drive 800K 40 80 trks switchable DS	£312 + VAT	£359
Dual Drive 800K 40 80 trks + PSU + built in monitor stand	£373 + VAT	£429

All above drives are low power slimline (0.3 A typ at + 12v and 0.4 at + 5v per drive) Normally extra power supply is not required. The BBC Computer power supply is designed to drive to low power drive (IT IS NOT DESIGNED TO DRIVE INTERNAL ROM BOARD)

SS DD disketts (10 Box) £18 + VAT £20
DS DD disketts (10 Box) £23 + VAT £26

● Circle No. 159

BUSINESS SYSTEMS

COMPLETE BUSINESS PACKAGE

This system is based on 16 Bit 8088 Processor 128K RAM, 2X730K Floppy Disc Drives, High Res Monitor, fast (160cps) Dot Matrix Printer, Wordstar Wordprocessor, Calcstar Spreadsheet Program, complete integrated Accounts package consisting of Sales Ledger, Purchase Ledger, Nominal Ledger, Invoicing, Stock Control, Payroll and mailing list. Complete turnkey system at an unbelievable price.
Delivered Only £1495 + VAT £1719
Delivered and Installed plus 1 day training £1595 + VAT £1834



SANYO PROFESSIONAL COMPUTER

SANYO 555

16 Bit Micro, 256K Ram, double 160K disc drives, MSDOS Operating System, free Green Monitor, free software Calcstar, Infastar, Datastar etc.
£999 + VAT = £1149

SANYO 550

16 Bit Micro, 256K Ram, Built in full colour graphics, MSDOS Operating System, Single 16K disc and free Green Monitor, free software including Wordstar & Calcstar.
£749 + VAT = £862

SANYO 550-IX

As above but with dual drives 2 x 160K
£799 + VAT = £919

SANYO 550-360X

As 550 but with dual drives 2 x 360K
£899 + VAT = £1034

SANYO 550-800X

As 550 but with dual drives 2 x 800K
£999 + VAT = £1149

SANYO 550-10MX

As 550 but with MSDOS 2.11 Operating System and a single 10 Megabyte hard disc and 360K floppy back up.
£1995 + VAT = £2295

SANYO 555-360X

As 555 but with 2 x 360K Drives
£1099 + VAT = £1264

SANYO 555 800X

As 555 but with 2 x 800K Drives
£1199 + VAT = £1379

SANYO 555 10MX

As 555 but with MSDOS 2.11 Operating System and a single 10 Megabyte hard disc and 360K floppy back up.
£2195 + VAT = £2525

APRICOT PC

"Portable Executive Computer" 16 Bit Micro. 256K RAM up to 1.44 megabytes floppy disk storage. 3 1/2" Sony disks. Portable brief case styling. Modem with auto dialler (optional) hard disk optional. Vast software library (compatible with Sirius Apricot with Double Drive, Monitor and Free Printer
£1790 + VAT £2059

Apricot with Double Drive, Double & Monitor & Printer £1990 + VAT = £2289

APRICOT XI

As above but with 10MB Winchester Drive and Single 315K Drive plus Superwriter, Supercalc and FREE JUKI 6100 Printer
£2995 + VAT £3444

WORD PROCESSING

COMPLETE SYSTEMS FROM £650 + VAT

BBC 1: BBC Micro Model B, View (or Wordwise) Wordprocessor, Quendata 20 CPS Daisywheel Printer, High Res Green Monitor, Cassette Recorder plus 10 cassettes and all the necessary cables
£600 + VAT = £747.50

BBC 2: BBC Micro Model B + Disk Interface, View (or Wordwise) Wordprocessor, 100K Disk Drive, High Res Green Monitor, Quendata 20 CPS Daisywheel Printer, 1 Box of Disks and all the necessary cables
£749 + VAT = £862.00

BBC 3: Same as System BBC2 but with 400K Drive
£825 + VAT = £949.00

BBC 4: Same as System BBC 2 but with 400K Drive and JUKI 6100 Daisywheel Printer
£925 + VAT = £1064.00

BBC 5: BBC Model B + Disk Interface, View (or Wordwise) Wordprocessor, 800K Dual Disk Drive (Mitsubishi), High Res Green Monitor, JUKI 6100 Daisywheel Printer, 1 Box (10) of 80 Track DS discs and all necessary cables
£1095 + VAT = £1260.00

SAN 1: Sanyo MBC 550 Series 16 Bit Microcomputer, 256K Ram, Dual 160K drives (2 x 160K), High Res Graphics (600 x 200 pixels in 8 colours), JUKI 6100 Daisywheel Printer, High Res Green Monitor, 1 Box of 10 discs, Wordstar Wordprocessor, Calcstar spreadsheet and all the necessary cables
£1095 + VAT £1260.00

SAN 2: Same as SAN 1 but with Dual 360K Drives (2 x 360K)
£1245 + VAT £1432.00

SAN 3: Same as SAN 1 but with Dual 720K Drives £1295 + VAT £1490.00
SAN 4: Sanyo MBC 555 Series 16 Bit Microcomputer, 256K Ram, Dual 160K Drives (2 x 160K), High Res Graphics (600 x 200 pixels in 8 colours) JUKI 6100 Daisywheel Printer, High Res Green Monitor, 1 Box of 10 discs, Wordstar, Wordprocessor, Calcstar spreadsheet, Mailmerge, Spellstar (dictionary), Datastar (database), Reportstar plus all the necessary cables
£1195 + VAT £1375.00

SAN 5: Same as SAN 4 but with Dual 360K Drives
£1295 + VAT £1490.00

SAN 6: Same as SAN 4 but with Dual 730K Drives
£1395 + VAT = £1605.00

If you require High Res Colour Monitor instead of High Res Green Monitor in Sanyo Systems please add £320 + VAT = £368 to the above prices.

*128K RAM Upgrade for all above Sanyo systems (makes a total of 256K RAM) £150 + VAT = £172.50 including fitting.

SOFTWARE CENTRE

CP/M

CP/M-86

MSDOS

MICROPRO SOFTWARE SYSTEM

PLANSTAR: Advanced financial planning..... £295
 WORDSTAR: Best selling professional Word Processing software: On screen formatting, Block manipulation, File read/write, Simultaneous Editing and Printing..... £295
 MAILMERGE: Enhancement for document personalisation and mailing applications..... £145
 SPELLSTAR: Enhancement for checking spelling and maintaining spelling dictionaries..... £145
 STARINDEX: Useful package for creation of Table of Contents, Index, List of Figures. Interfaces to Wordstar to improve document presentation quickly and easily..... £116
 INFOSTAR: Impressive Data Base system combining the power of Datastar with the flexibility of Reportstar..... £295
 DATASTAR: Screen based Data Entry, vetting and retrieval system. Screen formats under user control..... £175
 REPORTSTAR: Powerful report generator, provides much needed enhancement to Datastar for report production and transaction processing..... £210
 CALCSTAR: Electronic spreadsheet with Interfaces to all MicroPro

DATABASE MANAGEMENT

FORMULA II: Unique information management system with exceptional capabilities for Application Generation. Multiple files and indexes, transaction processing, interactive, no programming language required..... £450
 dBASE II: The most popular of data management systems, very powerful application generator..... £137
 QUICKCODE: Add-on facility for dBASE programmers to speed development process by generating dBASE command files..... £200
 dGRAPH: Extremely useful program for graphical representation of dBASE and user created data files..... £200
 dUTIL: Utility to speed up dBASE execution..... £69
 CAROBOX: Highly popular electronic card index system. Easy to use, with powerful retrieval facilities..... £195
 FRIDAY: End user file management system from the authors of dBASE II. File definition, input and reporting under user control..... £195
 OPEN ACCESS: Multi-function Executives Information System..... £450
 RETRIEVE II: Information Management with unique features..... £495
 EVERYMAN: Database Systems for the IBM-PC..... £475

NB: Combination prices — WS/MM
 £390; WS/MM/SP/SI £399



Telesystems Ltd

The Geans, 3 Wycombe Road, Prestwood, Bucks., HP16 ON2 Tel: 02406 6365.

LANGUAGES

Microsoft	CP/M	MSDOS	Digital Research	CP/M	CP/M-PCDOS	86
BASIC Interpreter	£325	£325	CBASIC Interpreter	£130	£275	
BASIC Compiler	£365	£365	CBASIC Compiler	£425		
FORTRAN Compiler	£465	£325	PASCAL MT +	£300	£325	£325
COBOL Compiler	£645	£645	C Compiler	£295	£295	
C Compiler		£465	PERSONAL BASIC Int		£125	
PASCAL		£285	CIS COBOL	£425	£425	
BUSINESS BASIC Comp		£550	FORMS-2	£110	£110	
MACRO ASSEMBLER	£185	£99	FILESHARE	£250	£425	
			FORTRAN 77		£295	£295
SUPERSOFT C Comp	£185	£185	SUPERSOFT BASIC Compiler	£200	£200	
PROFORTRAN	£220	£320	PRO PASCAL	£220	£320	£320

UTILITIES

ASCOM: The most flexible asynchronous communications package available to the micro world. Interactive, batch, menu-driven. Available for CP/M, CP/M-86, MS/PCDOS..... £170
 BSTAM: Simple communications program for exchanging files between CP/M systems..... £140
 TRANSFER: System for exchanging files between CP/M systems. Provided with full 8080 source code..... £130
 CONVMS: Operating system converter. Runs MSDOS programs under CP/M-86..... £70
 CONVCP: Operating system converter. Runs CP/M-86 programs under MSDOS..... £70
 ASSEMBLER PLUS: Disassembler for 8080 and 280 programs..... £167
 DISKEDIT: Facility for editing disk held data by sector. Invaluable aid..... £70
 IBM-CP/M COMPATIBILITY: Set of programs that enable IBM 3740 disks to be used on CP/M, permitting transfer of files to/from IBM mainframes..... £110
 SPP: Speed programming Package for use with Pascal/MT +..... £167
 XLT86: Converts 8080 assembler code to 8086..... £106
 EM80/86: Emulator to run CP/M software under CP/M-86..... £70
 DISPLAY MANAGER: Screen handling productivity aid for Digital Research compilers..... £333
 ACCESS MANAGER: File handling productivity aid for Digital Research compilers..... £333
 EXPRESS BASE II: Development aid for dBASE II..... £125

APPLICATIONS

MULTIPLAN: Exceptional electronic worksheet from Microsoft..... £159
 MULTI-TOOL WORD: Microsoft's advanced Word Processor with optional Mouse for added flexibility..... £299
 SUPERCALC: Fast action spreadsheet and planning aid..... £200
 ABSTAT: Powerful statistics package..... £295
 GRAPHSTAT: Versatile statistics and graphics package for the Epson QX10, IBM-PC and Sirius..... £195
 ALIAS ACCOUNTS: Fully integrated accounts system with inbuilt hooks to dBASE II..... £1200
 ALIAS PAYROLL/SPP: Standalone or integrated system with optional links to ALIAS accounts..... each £600
 RCS LEDGERS: Sales, Purchase, Nominal ledgers in MBASIC source code..... each £300
 RCS PAYROLL: Full function, highly used package..... £500
 STATISTICS PACK: Over 25 easily used routines in MBASIC..... £120
 MATHS PACKAGE: Interactive routines (40+) in MBASIC..... £120

MISCELLANEOUS

CP/M 2.2: Standard operating system on 8" disk..... £130
 CP/M-86: Standard 16-bit operating system..... £225
 SUPERSORT: Full function Sort/Merge/Selection package..... £145
 MSORT: Standalone and COBOL hosted Sort package..... £149
 MAGSAM: MBASIC utility to provide multi-key ISAM file facilities..... £150
 TOUCH 'N' GO: Teach yourself keyboard skills..... £40
 MICROSOFT MOUSE: Mouse, interface card and software..... £149
 OPTIMISER: Interactive Linear Programming package..... £325
 PROSTAR TRAINING GUIDE: Independent instruction on the use of MicroPro 'STAR' products..... £30

PLEASE CALL FOR FULL LIST

PRICES EXCLUDE VAT

DEALER ENQUIRIES INVITED

frazzled with floppies?

- Hard disc capacity 5-200Mb
- Removable disc cartridge 5, 10 or 21Mb additional on-line storage or back-up.
- PlusNet... allows shared access to hard disc.
- Supports Apricot PC, Xi, F1 and Portable; IBM and compatibles; Sirius, Epson, Sanyo and most other micros.
- Maintenance by ACT (Computer) Maintenance Ltd.*

Prices start at £1195

eg. 10Mb Hard disc
Subsystem **£1295**
20Mb Fixed with
5Mb Removable
Subsystem **£2645**

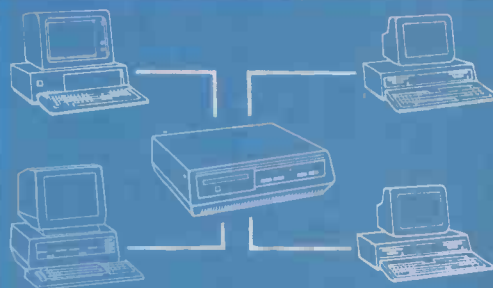

fit a Plus5 hard disc.

*Apricot & Sirius only



Plus 5 Engineering Limited Crowborough Hill, Crowborough, East Sussex, England TN6 2EG Telephone (08926) 63211 Telex 95538 PLUS G

The UK's leading subsystem manufacturer

RAMROM 15

The Sideways RAM & ROM Expansion Board for the BBC

The GCC RAMROM 15 board adds to the BBC Micro another eleven sideways ROM sockets plus the necessary hardware for sideways RAM.

FEATURES

- ★ Fully buffered board.
- ★ Rechargeable battery backup for RAMS provided as standard. Recharging circuitry is included.
- ★ The board can be powered by an external 5 Volt power supply, available as an optional extra.
- ★ The unit comes in a case of its own and resides outside the BBC Micro, giving easy access to the resident ROMS.
- ★ For those involved in development work, most of the 6502 processor signals are made available outside the BBC Micro.
- ★ Priority or selection can be assigned to either RAMS or ROMS.
- ★ ROMS can be used in RAM positions simply by changing two push-on links.
- ★ Simple installation – NO soldering.
- ★ Can be installed together with most other BBC add-on boards.
- ★ ZIF-sockets available as optional extras. Up to 15 may be housed on the RAMROM 15 at any one time.
- ★ All socket positions are software selectable.
- ★ Free Utilities Disk supplied.
- ★ Comprehensive User Manual included.

RAMROM 15 £129.95 inc VAT (P&P £3.50 inc VAT)
 EXTERNAL PSU £5.75 inc VAT (P&P £1.73 inc VAT)
 ZIFSOCKETS £9.00 inc VAT Free P&P with RAMROM)



Trade and local authority enquiries welcome.
 Prices correct at time of going to press.



GCC (Cambridge) Limited
 66 High Street, Sawston, Cambridge CB2 4BG
 Telephone: Cambridge (0223) 835330/834641
 Telex: 81594 SAWCOM

● Circle No. 172

STARdataBASE . . .

The database



for the BBC

STARdataBASE is the fast, machine-code, true random access, database program in 16K ROM for the BBC Microcomputer, complete with over 75K of FREE extension Software.

FEATURES:

- ★ Up to 4096 records in a file.
- ★ Up to 69 fields in a record.
- ★ Up to 255 characters in a field (subject to an overall maximum of 920 characters in a record).
- ★ An entirely User-defined record layout, including a facility for colour.
- ★ Can be used with 40 and 80 track Disk Drives.
- ★ Entirely Menu-driven, extremely User-friendly.
- ★ Extremely fast search – A single record can typically be found in 1 second using the Keysearch facility.
- ★ Search conditions include the following: =, <>, <, >, and "Anywhere in the field".
- ★ Powerful facilities to edit records.
- ★ Mail-merging between documents created on Wordwise or View, and STARdataBASE records.
- ★ Print-out of the whole database or selected Subsets, in the form of Record cards.
- ★ Address label printing – (up to 8 across the page).
- ★ Fully documented routines which can be included in user-written programs and interfaced with STARdataBASE.

STARdataBASE £86.25 inc VAT
 Post & Packing £1.75 inc VAT



GCC (Cambridge) Limited
 66 High Street, Sawston, Cambridge CB2 4BG
 Telephone: Cambridge (0223) 835330/834641
 Telex: 81594 SAWCOM

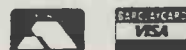

Trade and local authority enquiries welcome.
 Prices correct at time of going to press.

62 ● Circle No. 120

● Circle No. 183 ▶

GET THEM TOGETHER

TOTAL INTEGRATION

Would you like to have your financial forecasts and your word processing produced by one simple and easy to learn computer package?

Word Result and Calc Result can get them together for you.

WORD RESULT does everything you would expect of a word processor – such as letters, memos, updates, mail merge (i.e. combining your mailing list with standard letters) – PLUS it supports eight European languages with built in hyphenation (great for international businessmen, language schools, etc.). Word Result will automatically save information whenever you stop typing – to guard against unexpected power cuts etc.

CALC RESULT is a financial spread sheet which comprises 32 full pages with 64 columns by 254 lines which can be consolidated with ease. Pie and bar charts are displayed on screen and can then be saved and printed. All formulas are locked automatically. Financial forecasts have never been simpler!

TOTAL INTEGRATION Word Result and Calc Result have been created for the IBM and compatibles with true integration – giving you the freedom to use each program either separately or together.

TOGETHER Word Result and Calc Result can help your busy office take the strain.

Why not send the coupon in TODAY and find out what else these programs have to offer?

Why not send this coupon in TODAY and find out what else these programs have to offer?

**Please rush me details of
WORD RESULT / CALC RESULT**

NAME _____

COMPANY _____

POSITION _____

ADDRESS _____

Send to: **HANDIC SOFTWARE LIMITED**
5, Albert Road, Crowthorne, Berkshire RG11 7LT.
Tel: (0344) 778800



handic
software ltd.



CAMEL PRODUCTS

NIKE POWER BUFFERS

WAITING TILL YOU GET CAUGHT OUT?
Nickel Cad. batteries with ON-OFF switch. Versions for Spect., ZX81, ATMOS. Gives time to save program on tape. Visible status warning by LEDs £17.35.
DEALER ENQ. WELCOME.



EPROM PROGRAMMERS

BLOPROM-SP
A uniquely sophisticated EPROM PROGRAMMER

Eprom programmer for the 2516, 2716/32/32A/64/64A/28/128A, yes even the 64A/128A from Intel. Check, Read, Program & Verify all or part of Eprom. So immensely user friendly you'll hardly need the manual. Designed for the beginner but includes a single key entry route for the professional. Supplied as firmware, the m/c driver routine alone is worth more than the price of BLOPROM-SP. No Personality Cards, or other additions, just a Spectrum. Several inbuilt safety features. On-board Vpp generation. 28pin ZIF socket. Cabled connector and extender plug. ABS case. £89.95



STATUS NO. OF SYSTEM —HEX
EPROM TYPE —27126
RAM START ADDR —4000
EPROM ST ADDR —9000
JOB LENGTH — 4000
TASK — CHECK

WHICH TASK DO YOU WISH TO DO
W) CHECK THAT EPROM IS CLEAN
X) READ THE CONTENTS OF EPROM INTO RAM
Y) BLOW AN EPROM WITH DATA FROM RAM
Z) VERIFY THAT EPROM DATA IS THE SAME AS IN RAM
Q TO QUIT ——— R TO RESTART
FAST CODES AVAILABLE
D M POR WXYZ

BLOPROM-81
As above but for ZX81. Programs 2516, 2716/32/32A/64 & 27128 £79.95
AT LAST! for the Spectrum user. Put your programs, utilities, Assemblers into EPROMS for instant load from the unique ROM-SP



ROM-SP for Spectrum
Ingenious unit for Spectrum, with 2X28 pin sockets and a Reset button allows up to 16K of Basic or M/C program to RUN or LOAD instantly from EPROMS. Cabled connector and full extender card. NOTE: Does not disable Sinclair ROM. £29.95

PROMER-SP for Spectrum
A brand new Spectrum programmer for 2764/128. Zero insertion force socket & software on tape. £29.95

PROMER 81-S for Spectrum
The very popular PROMER-81 for the ZX81 has been adapted to the Spectrum and the price kept low. **NEW PRICE** £24.95

ROM-81
Provides two 24 pin sockets for up to 8K of EPROM memory in the 8-16K area. Can use 2516/32 or 2716/32 £14.95

PROMER-81
A low cost reliable programmer for 2516/32, 2716/32 EPROMS. Requires 4XPPP3 batteries **NEW PRICE** £24.95

DHOB1 1 **UV ERASER**
Compact. Mains powered. Safe. Fully cased. Up to 3 EPROMS £18.95

DHOB1 2 With automatic timer £22.95

CRAMIC-SP **NEW** for Spectrum
Ingenious software paged 16K non-volatile CMOS RAM to co-exist in the same area as Spectrum ROM. Easy storage and retrieval of BASIC, M/C or DATA on a 48K Spectrum £89.95

PRINT-SP **NEW** for Spectrum
Centronics Interface with standard centronics Cable. Plus free introductory offer SP WRTIE text processor. £31.25

DREAM-81 **ZX81**
64K Rampack with link options to disable 0-8-16K. Plus a 28 pin EPROM socket for 2716, 2732/2764 and 27128. £59.95

MEMIC-81 for ZX81
4K CMOS RAM with lithium battery. Easy SAVEing, 10yr storage and instant retrieval of programs. £29.95

INTRODUCING MULTEPROM
The most economical, sophisticated gang copier in the world. Based BLOPROM £199.95



UK. VAT extra. No VAT on exports P+P UK Free
Europe +5% — Overseas +10% TLX 81574 CML
Cambridge Microelectronics. One Milton Road.

Cambridge Microelectronics Ltd., One Milton Rd. Cambridge. CB4 1UY Tel: (0223) 314 814

Anglia Computer Centre

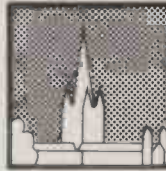

Business Computers Division
88 ST BENEDICTS STREET
NORWICH NR2 4AB
PHONE (0603) 667031/2-7

Authorised dealers for IBM, COMPACQ, APPLE & APRICOT

Est. 1979

SPECIAL OFFER
to celebrate
5 years in business
10% OFF
the above
Micro Computers

Also branches at

26 Princes Street
Ipswich IP1 1RJ
Phone (0473) 214121-3

Wentworth St.
off Bridge St.

Peterborough PE1 1DH
Phone (0733) 311755
4 lines

Parker's House
Regent Street

Cambridge CB2 1DP
Phone (0223) 315633
4 lines

● Circle No. 170

IBM PC COMPATIBLE MODEMS

A significant number of communications software packages for a variety of personal computers, not least of which is the IBM PC, use the Hayes protocol. Adoption in the UK has been limited because of the unavailability of compatible modems approved for connection to British Telecom lines.

Our range of autodialling Duplex modems may now be purchased in Hayes compatible form. The modems interwork with all known Hayes compatible software packages and obey all Hayes commands except where this would violate British Telecom rules for redialling attempts and time delays.

Duplex Systems offer a complete solution to any communications problems that may arise in the office, from connecting a printer to purchasing a complete office system capable of electronic mail, telex and facsimile:

Modems and acoustic couplers, T-switches multiplexers and buffers, interfaces for a wide selection of typewriters, interface converters, printers and terminals, telex interfaces and full message switching systems —

To find out what is possible with the latest technology contact:

DUPLEX SYSTEMS LTD.
Radford Business Centre,
Radford Way,
Billericay,
Essex CM12 0DG

Tel: 0277 841011 Telex: 995540

● Circle No. 174

VIZAWRITE PC WORD PROCESSING

VIZAWRITE is probably the easiest business program that you will ever use!!

Right from the start, just type onto the screen and your words are instantly laid out on the page.

Just like a professional typist, VIZAWRITE knows when to end each line so that pages are produced with neat margins, inset paragraphs and perfectly lined up tabulations.

Now you can concentrate on what you're typing, not how to type. Documents take on a new look of professionalism. Produce memos, lists, letters and complete reports with incomparable speed and ease.

VIZAWRITE can also proof-read your work, excellent at picking out those 'juggled' words that get typed when the phone rings.

Document statistics, how many words you've

typed, VIZAWRITE shows you — instantly.

VIZAWRITE is so easy to use, THE TIMES featured it again and again in no less than three separate articles on word processing for newcomers.

We've even included some of the latest software 'fashions', such as WINDOWS to view several documents at once, such as PULL DOWN MENUS that assist command selection, such as on-screen HELP if you can't find the manual!!... and much more.

VIZAWRITE is an extremely advanced word processing package with powerful layout and filing commands.

Remember that VIZAWRITE has achieved an ease of use that you won't find in any specification. It's intuitive, simple and fast.

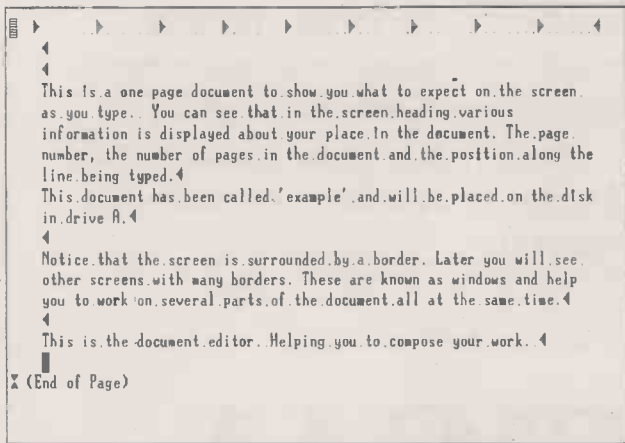
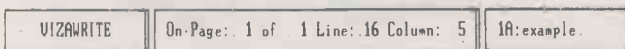

The Document Editor Screen

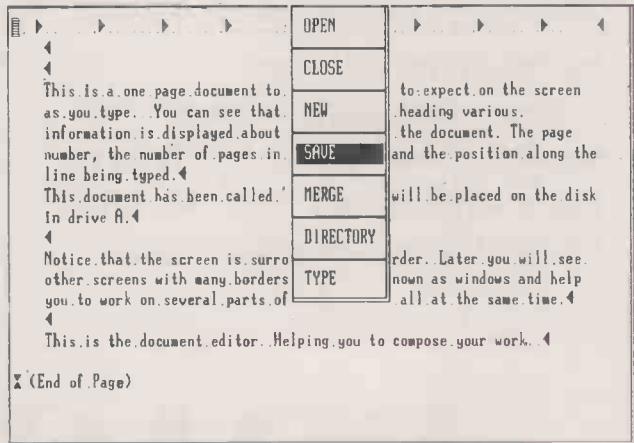

The Command Menu

VIZA SOFTWARE

Call us now, or fill in the coupon for more details.

VIZA SOFTWARE LTD.
9 Mansion Row, Brompton,
Gillingham, Kent ME7 5SE
Tel: (0634) 813780.



Please send me further details about VIZAWRITE PC and the name of my nearest dealer.

Name _____

Company _____

Address _____

PRC

THIS WILL DO NICELY!



Now you've seen the new (and vastly improved) Practical Computing, make sure you receive it regularly every month by returning this card.

You won't want to miss what we have lined up for the future – more applications features, more on multi-user systems, more

problems answered, more on communications and more view-points from industry leaders.

What more could you ask for? Except to receive it regularly, of course!

PRACTICAL COMPUTING

*Get it regularly –
send the card – today!*

News from the world of
Sinclair QL computing.

QL NEWS NEWS

The communications explosion takes shape!

Communications are now
the most exciting, essential part of any computer.

In the past six months alone, over 150,000
modems have been sold in the UK.

Now, the QL's own communications explosion is
taking shape ... and it has the potential to make
more of communications than any other micro!

Read on and discover exciting new ways to use
your QL ... with the QL modem ... telephony
unit ... and powerful interface options.



DAVID KARLIN

Why Q COM is everything you could wish for in communications.

The QL is now communicating – via Q COM! This exciting three-part peripheral presents QL users with a multitude of ways to exploit the world of communications.

Once connected to the QL, Q COM allows you to access the considerable number of phone-in databases, such as Prestel and QNet.

Q COM enables you to communicate with other computer users. Its facilities include electronic mail, data transfer from Microdrives and bulletin boards.

Through it you can link your QL to larger minicomputers. Q COM has full capability in this area, and allows the QL to talk to powerful mainframes.

Q COM's automatic dialling

and call acceptance facilities, together with the storage of messages from other modems, will revolutionise the way you use your telephone.

The next few pages of QL News tell you much more.

It's enough for me to say here that with the QL and Q COM,

you'll be exploring new openings in communications for some time to come!

David Karlin,
Chief Design Engineer.



The Q COM package

Three special parts to stack!

 **QL communications interface**

This multi-speed interface contains the sophisticated software used to set up QL communications – and to control the Q CALL and Q MOD units.

Q CON also comes complete with Microdrive-based software. This enables the QL to link to larger computers using VT100 and viewdata protocols.

The software will also run any standard modem – connected via Q CON's built-in RS-232-C port.

Most importantly, Q CON allows the QL to transmit and

receive at rates switchable from 75 to 9600 baud (encompassing the widely-used 75/1200 Prestel rates, and 1200/1200 half duplex rates for user-to-user exchange).

Q CON is specially styled to suit your QL – with similar fluting and ribs – and forms the base module of a vertical-stacking system.

It's supplied with full instructions, software on Microdrive cartridge, and connecting leads.

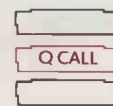
 **QL auto dial/answer unit**

Q CALL gives every QL user something out of the ordinary.

It's a module which links directly to your telephone, and allows auto-dialling at the push of a single key. In the same way, it will permit incoming calls to be

accepted automatically... and even trigger pre-programmed activity from the QL!

Q CALL is the central unit of the package. It plugs directly into Q CON – so there are no connecting cables to worry about.

 **QL modem**

Q MOD has all the powerful facilities expected of a modem, in a neat and simple unit.

It uses either V23 75/1200 or 1200/1200 baud rates, for Prestel, Micronet 800 and all the

viewdata services described alongside.

It also incorporates a telephone extension socket for manual dialling.

Q MOD is the top unit of



Q COM, and comes with a 9' built-in telephone cable.

All three units are available from Sinclair on (0276) 685311 and from selected Sinclair stockists.

The QL hooked on voice and data

The QL can now act as your personal address book and telephone operator!

Q COM allows you to store hundreds of personal or business numbers.

You can store lengthy passwords and account numbers – and recall them – at the touch of a single key.

And any information that's sent to you from other modems-owners can be gathered and stored on Microdrive cartridge, or incorporated into your QL Quill documents!



Exploring the world of QNet, Prestel, Micronet and more!

Thousands of QL users already enjoy the excitement of linking to a nationwide mainframe.

Q COM turns your QL into an intelligent terminal, allowing you to access many thousands of pages of information, software and communications facilities.

The services brought to you through Prestel can include Micronet 800, Viewfax 258 and QNet, the new QL database.

Membership of QNet will bring you free software, QL news and features, and all the wide-ranging services of viewdata!

If armchair shopping is more

your style, that's easy too. It's often possible to place a direct order using your QL! For dedicated QL owners, there's a daily selection of software reviews, chart toppers... and all the facts and figures you need to make buying peripherals simple.

With Q COM you can also 'download' software from the system directly into your QL and either use it immediately, or store it on Microdrive cartridge.

In fact the only problem you'll face with a viewdata service is finding enough time to explore its many features!

You can find out how to join QNet by phoning 01-278 3143.

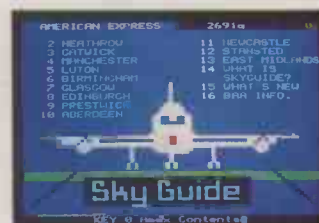
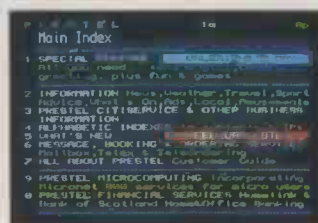
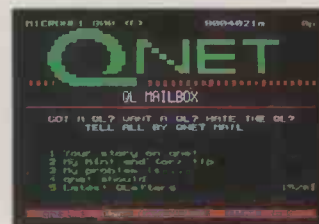
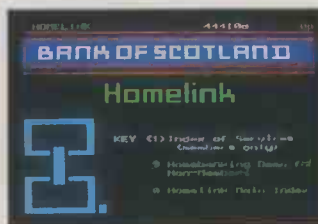

News... information... banking services and QNet. And only a fraction of the QL's new viewdata capability.

QL meets the mainframes!

The Q CON unit of Q COM turns your QL into a VT100 terminal, providing instant access to in-house computing services, both mainframe and mini.

Whether you are using your QL at home or at work, Q COM gives you access to electronic bulletin boards which provide help and advice 24 hours a day. You can leave messages or notices for friends or business contacts and even hold live discussions with them.

Additional benefits for the QL business user include easy access of in-house company software, and the interrogation of other data bases around the country.

There's also the opportunity of linking to British Telecom Gold – the widely-publicised and popular messaging service.

sinclair

QL Hardware

Microdrive cartridge price cut to only £1.99!



Sinclair Microdrive cartridges – up to 100K of programs and data on a medium so compact you can pop it into your pocket.

On February 1, the cost of Microdrive cartridges came down from £4.95 to £1.99 each.

Microdrive cartridges are the QL's own unique storage medium. Each stores up to 100K of information (that's 40 pages of A4 text), on a cartridge no bigger than a book of matches!

Over 500,000 cartridges are now being used throughout Britain.

You can store up to 50 different data files per cartridge, identified by titles of your own choice.

And QL Microdrives themselves are standard equipment on the new ICL One Per Desk micro, and British Telecom's new Merlin Tonto.

IEEE-488... the instrument connection

IEEE-488 is the interface standard set by the Institute of Electronic and Electrical Engineers for instrumentation control.

IEEE-488 – or General Purpose Instrumentation Bus – is a parallel interface specifically designed for high speed data transfer between a number of

different types of device.

It is commonly used for controlling instrumentation via a computer, allowing the creation of laboratory data acquisition systems, industrial control schemes, etc.

The QL now has a fully-fledged IEEE-488 interface from CST. It plugs neatly into the QL's RAM expansion port, and can control up to 16 instruments simultaneously.

It's available from CST on (0223) 323302.

New inte 3 1/2" or 5 1/4"

With new Q-Disk, you can transform the QL into a powerful small business system – comprising QL, monitor, disk interface, twin disk drives and printer.

Q-Disk upgrades the QL to disk storage. Fitting easily into the QL's left hand RAM expansion port, without the need for a special expansion box, it contains a Western Digital disk controller chip. Software is held in an on-board EPROM (so little of the QL's RAM is used).

Plug in Q-Disk, and the QL accepts one or two disk drives, sized 3 in, 3 1/2 in, 5 1/4 in, either 40 or 80 track, single or double-sided. Even when two drives are used, they can be different types!

Q-Disk offers up to 1.6 Mbytes of quick, reliable storage with a compatible disk drive.

It's made by Computamate, who also offer a full range of



An IEEE-488 interface slips discreetly into place.



QL to link students

Strathclyde University, in Glasgow, plans to have a campus network of 7,000 QLs linked to a central VAX minicomputer.

That's one QL for every student... a major investment project in a university which is now a leading centre for artificial intelligence work.

Sinclair is giving support worth £250,000 to the project. And it's likely that QL users

everywhere will benefit – the students plan to develop AI programs to run on the QL!

The QL has impressed Prof. James Alty of the University's Computer Science Department, who says *'only the QL could offer the computing power, range of applications, and above all the portability, at a realistic price.'*

ace to connect 3, disk drives

complimentary QL disk drives.
To contact Computamate,
phone (0782) 811711.



Single disk unit fitted with 5 1/4 inch drives and (inset) the Q-Disk controller.

The QL's high-tech spec

Dimensions

138 x 46 x 472mm
(5 3/8" x 1 3/4" x 18 3/4")

Weight

1388 gms (3.055 lbs)

RAM

Massive 128K standard RAM, externally expandable to 640K. Extra RAM is available in 64K, 128K, 256K and 512K units, from third-party suppliers.

ROM

48K, containing Sinclair SuperBASIC and the Sinclair Qdos operating system.

CPU

Motorola 68008 (running at 7.5 MHz) for all principal functions. (Architecturally, the 68008 is a 32-bit processor with an eight-bit data bus. One megabyte of non-segmented address space is available.)

In addition, an Intel 8049 controls the keyboard, generates the sound, and acts as an RS-232-C receiver.

Operating system

Qdos (developed by Sinclair Research) is a single-user multi-tasking, time-sliced system using Sinclair SuperBASIC as a command language with display handling for multiple screen windows; and device-independent input-output.

Language

Sinclair SuperBASIC, with the advantages of procedure structuring; extendability (including syntax); interpretation speed independent of program size; clean machine code interface; operating system facilities accessible from SuperBASIC; equal capability for strings and arrays; and full error-handling facilities.

Microdrives

The QL incorporates twin QL Microdrives, each with a minimum 100K capacity, 3.5 seconds average access time. Typical loading rate of machine code programs is 2-3K per second.

Video

High resolution graphics capability with colour or monochrome monitor (or TV) in two modes – 512 x 256 pixels (four

colours available) and 256 x 256 pixels (eight colours available). Normal character display format of up to 85 x 25 with choice of character sets available (TV format of up to 40 to 60 columns depending on the software).

Keyboard

Full-size, 65-key QWERTY keyboard featuring a space bar, left- and right-hand shift keys, five function keys and four cursor control keys. The keyboard can be angled by means of detachable feet.

Expansion

Excluding RGB monitor, power socket and TV port, eight peripheral/expansion ports are provided – one internal expansion, one Microdrive expansion, one ROM cartridge, two serial and two control channels, and the local area network.

Serial

Two standard RS-232-C communications interfaces for printers, modems, etc. Transmission at rates from 75-19200 baud or full duplex transmit/receive at seven rates up to 9600 baud.

LAN

For up to 64 QL computers. Data transmission over the net can be achieved at 100K baud.

Power supply

9VDC at 1.8A, 15.6VAC at 0.2A.

Joysticks

Provision for one or two devices for games or cursor control.

Applications Software

QL Quill – word processor
QL Abacus – spreadsheet
QL Easel – graphics
QL Archive – database
All four packages supplied with the QL.

Price

£399 including VAT, QL programs, full A4 manual, power supply, 4 blank cartridges and free Helpline service.

QL Software

Updated versions of Psion software now available!

QL Abacus, Archive, Easel and Quill are the four Psion programs supplied with every QL. They're now converted to 100% machine code, and as a result they load from Microdrive cartidge much faster.

The overlays present in Version One software have been removed, resulting in noticeably quicker on-screen performance.

With the compactness of machine code, there's a big saving in QL memory too – all four programs now cope with larger, more professional applications!

Version Two software is now supplied with every new QL. Existing QLUB members – see back page.

QL-Quill

QL Quill makes it easy to type in, correct and store your letters, memos and reports.

No training is needed – a beginner can be using QL Quill for word-processing within minutes!

QL Quill has the facilities of professional word processing packages: including word wrap, search and replace, justification, page headers and footers.



QL-Abacus

QL Abacus is a powerful, yet easy-to-use spreadsheet.

The program allows you to manipulate the contents of whole rows and columns by the names you assign them. There's no need to depend on confusing letters and numbers.

QL Abacus also incorporates a range of functions which let you carry out rapid 'what if' analyses on your data.



QL-Easel

QL Easel allows you to create graphs, bar charts and pie charts – at the touch of a key.

The program handles anything from lines and shaded curves to overlapping or stacked bars.

QL Easel designs and scales automatically or under your control. Text can be added and altered as simply as data.



QL-Archive

QL Archive is a sophisticated, powerful database program.

It includes a screen editor which allows you to design your own screen and format your reports, and a procedure editor which lets you tailor QL Archive to your own requirements.

QL Archive is ideal for all database uses, yet it's powerful enough to be used by many software houses to generate specific database applications.

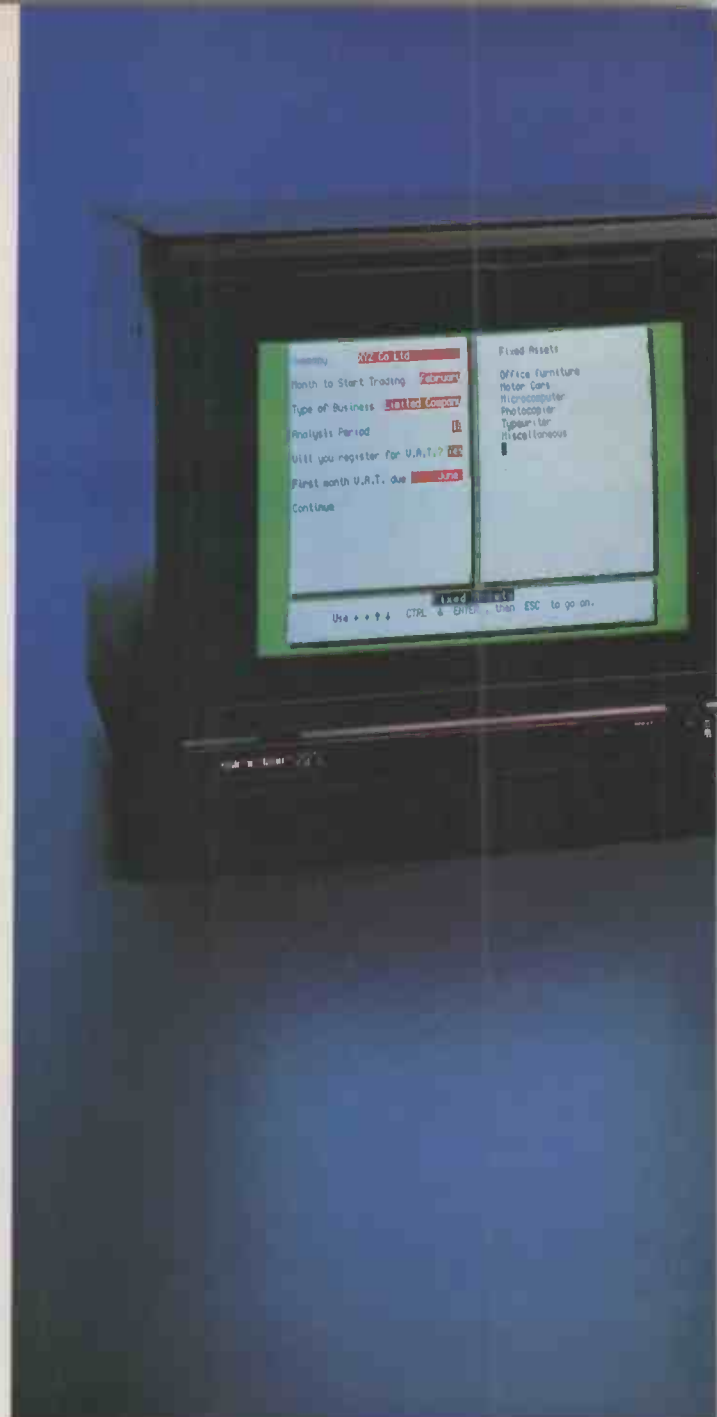
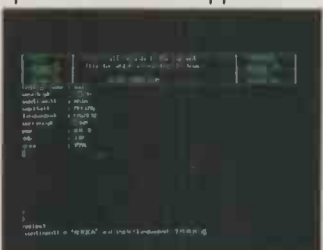

(Left to right) QL Entrepreneur, QL Project Planner and QL Decision Maker from Sinclair.

Coming soon- QL-Entrepreneur, QL-Project Planner, QL-Decision Maker!

Three new QL business programs – with a difference!

QL Entrepreneur, QL Project Planner and QL Decision Maker train you to apply new and exciting management skills – through original and powerful means!

An interactive teaching program gives you a thorough and enjoyable understanding of each subject – backed by a textbook and 'self-test' facilities – and an applications program helps you to use your new expertise for specific problems and projects.

All three titles will increase your understanding and extend your control – making involved subjects easy, stimulating and useful!

Non-members of QLUB can purchase new versions of the above software for £15 per title, or £50 for all four programs. Phone (0276) 686100 for details.

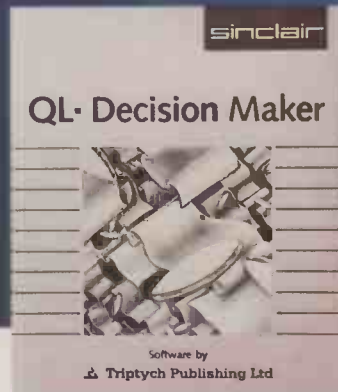
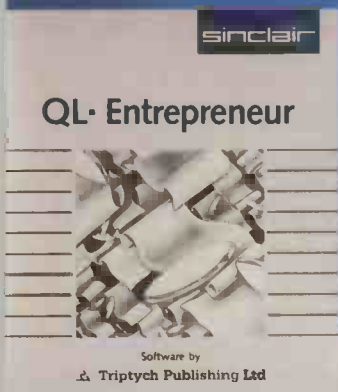
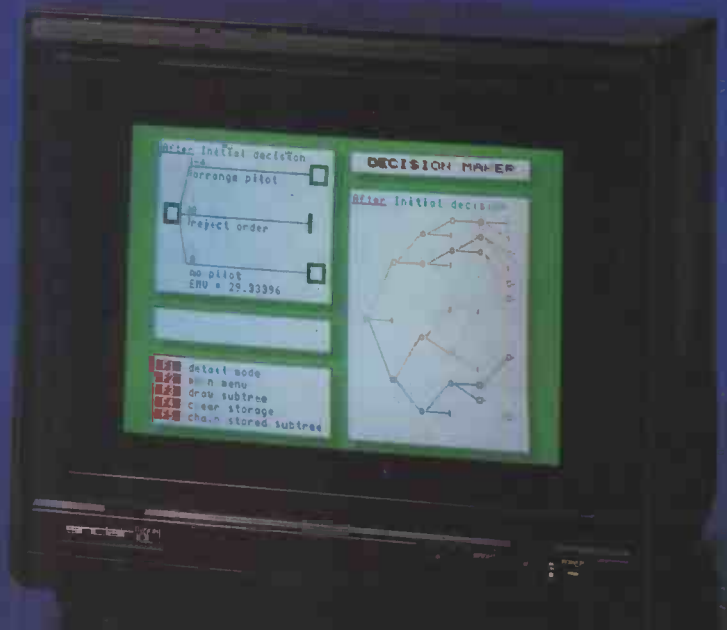

QL-Entrepreneur

QL Entrepreneur is an essential program for anyone preparing to start a new business – whatever it may be!

It uses a 'question and answer' format to help you build a workable business plan.

With the input you give, it works out the break-even point of the business; the first 18 months' cash flow, the type of finance needed; the year end Balance Sheet and Profit and Loss accounts... and more!

QL Entrepreneur builds your skills and techniques.

It's flexible too, so that you can ask complex 'what if' questions at any stage!

The program comes with a third blank Microdrive cart-

ridge and a comprehensive A5 manual.

QL-Project Planner

QL Project Planner will produce plans you can understand, monitor and more easily achieve.

First, you break the project down into its individual activities, telling QL Project Planner how long each takes and which are inter-dependent.

When you decide on a starting time/date QL Project Planner will tell you when each activity must start and finish and when the project will be completed.

Each activity is divided into its critically important stages – those which can safely be moved around without altering

the time taken by the project and those where movement will affect the completion deadline.

Whether or not you've used project planning systems before, you'll be amazed at the difference QL Project Planner can make.

The program comes with a third, blank Microdrive cartridge and a comprehensive A5 manual.

QL-Decision Maker

Whether you're thinking of buying a house, or taking on a new business contract, QL Decision Maker makes the choices clearer!

It lets you look at the possibilities – and their implications – through a decision tree.

Once you've set out the decisions and their probable costs or results, QL Decision Maker shows the outcomes which would occur from each particular route.

You can see how much money a decision could make for you... or cost you. Complex 'what if' questions are dealt with swiftly and graphically.

You can depend on the QL to highlight the best possible route!

QL Decision Maker comes with a third, blank Microdrive cartridge and a comprehensive A5 manual.

All three programs are available from Sinclair stockists, price £39.95 each, or Sinclair Research. Tel: (0276) 686100.

Now, buy a QL and you're a member of the QLUB-free!

QLUB is the special Users Bureau for Sinclair QL owners.

Already, there are well over 10,000 QLUB members . . . enjoying a whole range of information and advisory services.

Until now, joining QLUB cost £35 per year. From March 4, every new QL

owner can become a member – free of charge!

With your new QL, you'll find a post-paid form. Complete and mail it, and you'll soon be a member of the fastest growing computer club in the country.

And you'll enjoy all the helpful services listed here!

Special discounts

QLUB members also receive a range of special discounts, with savings of at least 20% on selected software products.

There are also special subscription rates for Personal Computer News and QL User.

Free Helpline service from Psion

All QLUB members are entitled to 12 months special assistance from Psion.

They're at the end of the telephone to answer any questions on using the QL Abacus, Archive, Easel and Quill programs supplied with the computer.

Help is also available on any aspect of using Sinclair SuperBASIC, Qdos, or linking your QL with major peripherals.

Psion will normally answer any queries within 48 hours.

QL program updates are no longer available free to QLUB members. They will be sold separately.

Good news for existing QLUB members too!

As one of the first members of QLUB, you should already have received one free update of each of the four QL programs – and a letter with your new membership details.

If for any reason you haven't, you should ring (0276) 686100.

You're a QL owner, but not a QLUB member?

Then joining QLUB is easy and free! Ring (0276) 685311 for full details. You can be a full QLUB member within a few days.

What QLUB membership offers you

Regular newsletters delivered to your door

One of the most important QLUB benefits is the special news magazine, appearing six

times a year. The magazine provides a forum for QL owners to exchange views and keep in

touch with all the latest developments.

Each issue is packed with updates on QL hardware and software, tips on applying the four QL programs, and news of how other people are using the QL.



Where to find the QL

The Sinclair QL is available at selected branches of Dixons, WH Smith, John Lewis Partnership, Currys, Greens in Debenhams and Ultimate, and larger branches of Boots, John Menzies and specialist computer stores nationwide.

Sinclair, QL, QLUB, Qdos, and SuperBASIC, are Trade Marks of Sinclair Research Ltd. Quill, Easel, Archive and Abacus are Trade Marks of Psion Ltd.

Sinclair Research Ltd
Camberley, Surrey, GU15 3BR
Tel: Camberley (0276) 686100.



Can ICL make it at last? Chris Bidmead tells the sorrowful tale of a stint with the new executive work station in pride of place in his office.

ICL has placed itself centrally in the U.K. micro market, so the success or failure of the radically designed One Per Desk is important — and not just for ICL but also for the cluster of firms which could thrive from supplying software and peripherals for a successful U.K. product. ICL needs a winner badly, following the disappointing sales of its PC, the badge-engineered Rair Black Box. It therefore gives me no pleasure to report that the OPD is the most disappointing machine I have ever had to review.

I use a pair of telephone lines. The OPD's single phone is able to service both, either by using the keyboard to shuttle between the two lines, or by reserving one line for data and the other for voice. Making the connection is simply a matter of unplugging your existing telephone, and plugging a pair of standard modular jacks at the ends of two cables that run off from the OPD.

The only other connection needed is the power supply which, rather unusually, runs to the screen. A single cable carrying power and data connects the screen to the cream and chocolate coloured combined keyboard, central processor and Micro-drive unit.

Small but legible

The OPD screen looks tiny beside my Cifer terminal. The Top Level Menu appears on the glare-resistant surface of the OPD screen, and as you explore the various other levels you come across a variety of character sizes, all of them shaped very like the printout from an Epson dot-matrix printer: readable but hardly elegant.

I am not a fan of menu-driven software but for those who are the OPD should be enough to confirm that some aspects of software design are not a matter of taste. There is such a thing as a bad, unhelpful user interface. Choosing functions from menus quickly palls once you understand the system. If they can be disposed of and you are able to revert to the faster process of hitting function keys or control-key sequences that are easily remembered, as in WordStar, the menus can be justified as beginners' aids. This is not to advocate WordStar as the bee's knees in software ergonomics, but it does show that command sequences can be made memorable through mnemonics.

But who can remember that the four-key sequence Start 551 allows you to search the OPD's Computer Services directory? All ICL's OPD software leans heavily on menus of functions which are accessed by hitting numbers and/or function keys. The OPD's menus are not even designed to disappear: when you enter the sequences quickly enough to out-strip the menus you also use up the almost non-existent keyboard buffer.

As an intelligent phone, the OPD has a great deal to offer.



ONE PER DESK

Using numbers to select functions is particularly silly on the OPD because the numeric pad also has to double as a telephone dial, a function-key pad and a set of telephone-function controls. It therefore sends clicks down the line while the phone is off the hook. You can take special action to reattach the numeric pad to the keyboard, or use the number keys positioned along the upper row of the keyboard instead, but it all helps to add to the confusion.

There are two kinds of phone call you can make from the OPD and separate telephone directories cater for each group. Voice calls are made by lifting the receiver and using the numeric pad to dial in the conventional way, or by calling up the directory and selecting an entry, which triggers the autodial mechanism. You can select either of the two lines to dial out on; the system defaults to line 1, which it prefers to think of as the voice line.

Line 2 is ordinarily the data line, reserved for sending and receiving text

through the dual-speed — 300 baud and 1,200/75 baud — modem built into the system. Again numbers can be dialed manually or activated by a directory. The Computer Services directory needs to contain additional data about transmission speed and format — whether it is Teletype or Viewdata. This is organised by keeping a look-up table in RAM that lets you give names, called profiles, to combinations of speed and format. To simplify the process of writing call signs and passwords, the Computer Services utility lets you encode strings of characters on to key combinations.

Calls can be automatically timed and costed by reference to an internally held table of call charges, and the system will also accumulate total costs. But I found the call-timing system of doubtful use in keeping a serious record of phone charges. Once the phone has been picked up, the OPD cannot tell whether you are dialling, connected with your contact at the other end of the line or merely listening to the ringing tone. The OPD begins timing the call after about eight rings, so that even if your recipient does not respond the OPD's internal accounting already shows a debit of one call unit.

Automatic messages

The voice-response feature was also disappointing. Inside a dedicated text editor you can assemble a limited vocabulary of words to form a message to be transmitted automatically down the telephone line in response to calls received while you are

(continued on next page)

(continued from previous page)

away from your desk. This ought to be useful, particularly as you can keep a glossary of messages and send out different ones at different times of day.

Putting the messages together was simple. The software helps by offering you a list of the words the sound chip knows how to pronounce. It also allows you to enter free-form text, and highlights words that lie outside the permitted vocabulary. Unfortunately, the output from this well-designed software module is a croaking Dalek-type voice which alienated some of my callers and sent others into fits of laughter.

Callers are disconcerted by the auto voice response because of the OPD's narrow bandwidth and because they expect to be able to leave a message after the tone, as you would on an answering machine. Possibly the system would have some internal use in a large organisation, but it is not something that outside customers or contacts should be exposed to.

When I set about making voice phone calls using the directory I discovered that for all its packaging as a communications system, OPD offers no way of getting names and phone numbers across from my old Almarc CP/M crate except by re-keying manually. The voice directory is rigidly structured, offering entry fields for Name, Title, Initial and Description. There is enough room in the description field for you to make notes, but an extra Remarks field would be useful.

Talking to each other?

Psion's Xchange applications software is available on ROM as an optional extra. The Xchange database system, Archive, allows the same sort of flexibility of structure as dBase II, and would be a more suitable vehicle for the built-in phone book but for one problem. It was here that I began to glimpse the gloomy depths of ICL's software design: Archive does not know it is running on a machine with a built-in modem. It does not even know that the OPD keeps a system date. The same is true of all the Psion software, so every time you write a letter you must manually copy the date from its permanent display at the bottom line of the screen.

At this point I discovered that opening a round bracket to enter parenthetical remarks into the phone directory, or anywhere else, made the system try to send out the screen contents to the printer. This was followed shortly afterwards by a beep and the message "Printer Inoperable" since there was no printer attached. This was obviously a bug so I phoned ICL who offered to come and fix it the next day.

The bug puzzled the ICL representative. The same problem had turned up in earlier versions of the software but had been dealt with long ago. He swapped the review machine for another and left me to continue my explorations.

I ran again through the configuration routine used to set up parameters such as the printer type and what programs you want to run automatically on power-up. The configuration routines are written in Basic, which, unlike on the QL, is not standing by in ROM but has to be hauled in from one of the Microdrive cartridges. Once Basic is in place it has to fetch the main system configuration menu, and it appears the process from start to finish takes three and a half minutes.

Remembering that the OPD is supposed to be a multi-tasking machine, I thought I would spend the time it takes to get into the configuration menu doing something else. So while Config was loading I hit the Start key to go back to the opening menu, and from there branched to the Xchange package to enter Quill, the Psion word processor.

I had written five words of notes when the word processor died with an "Out of memory" message. On returning to Config I found that Basic was having the same problem. Both routines had choked each other to death and I could find no way of recovering either program. I had to go into the Housekeeping routine, delete both from memory and start all over again. So much for multi-tasking.

I had to revise my feelings about the OPD's multi-tasking a couple of times during the course of the trials. The aspects of multi-tasking that work are certainly a persuasive argument against the plodding one-job-at-a-time approach of the more expensive IBM PC. If you have two tasks on the go — say, a word-processing task in Xchange and the saving to cartridge of a telephone directory — then the Resume key will toggle between the two. If more than two tasks are running, the Resume



Above: Sinclair ULAs are prominent on the ICL-designed main board.
Below: The Xchange ROM cartridge.



key gives you a menu of them and lets you pick the one you want to activate.

The literature claims that up to eight tasks can be run simultaneously. This claim is justified if the tasks are small and carefully chosen. But in everyday use two problems arise: some of the ICL software is not written to run alongside anything else, and memory constraints are rather tight.

If you are in the middle of updating your telephone directory and need to break off to see some details in a Quill file, you might expect to be able to move a section of text simply and easily from the word processor to the telephone directory. In fact, you can't. More seriously, when you return to the telephone directory by hitting Resume, you find you have dropped back on to the main menu. If you climb up into the phone directory again by hitting Start 12, you discover that your partial entry has gone, together with the details you have already entered.

The OPD's 128K of RAM sounds generous by the standards of a BBC Micro or a CP/M-80 machine but it is a tight constraint on a more ambitious operating system. First, the screen takes up a quarter of the memory even if you are only working in monochrome. The operating system grabs another 16K, leaving a user space of approximately 80K. This has to be shared between program and data because the philosophy of the OPD is only to use the slow Microdrives as end-of-day backup. A further invasion on the space is that the Xchange suite grabs 22K of RAM every time you activate it.

Yet another limitation is that memory becomes fragmented as blocks are allocated and erased in the course of running

Specification

CPU: Motorola 68008
Memory: 128K RAM with 32K used for screen; 2K battery-backed CMOS RAM for system parameters; 144K to 352K of ROM containing systems software, OPD Basic and applications programs
Keyboard: 73-key QWERTY including telephone-style numeric keypad
Display: 9in. monochrome or 14in. colour screen
Sound: TI 5220 speech synthesiser with 152-word vocabulary in ROM
Cassette: two built-in 100K Sinclair Microdrives
Interfaces: RS-232 printer port, as Sinclair QL
Modem: BT-approved autodial/autoanswer
Dimensions: control unit is 440mm. (17.3in.) by 250mm. (9.8in.) by 95mm. (3.7in.); weight, 3kg. (6.6lb.)
Price: monochrome version on £1,195; colour version £1,625; Xchange £130 extra
Supplier: International Computers Ltd, ICL House, London SW15 1SW. Telephone: 01-788 7272

Screen, keyboard and Microdrives

The ICL software divides off the bottom three lines of the screen as a noticeboard area, where the time, date and aspects of the system status can be posted. Several intensities are displayed: two shades of grey in 80-character mode and six shades in 40-character mode; with the colour monitor they appear as separate colours. Some of the lower intensities are not easy to read. Unlike the excellent Olivetti M-24 monochrome monitor there is no easily-got-at contrast adjustment to compensate for this, and all you have is brightness control. The screen automatically turns off if you stop using it for 10 minutes or so. Hitting any key turns it on again instantly.

The keyboard is bright and responsive, and I found it very nice to type on, despite the eccentric layout. The standard typewriter keys are brown. There is no colour distinction between these and the control key or OPD special keys like Start, Resume and Recall, which are used for switching between tasks. The cursor keys, also brown, are split on either side of the space bar, which I found distinctly annoying.

The Escape key is also brown but unlike most computer keyboards it does not have the key-top to itself. Instead it is Shifted above the asterisk key that is part of the numeric keypad. There is another asterisk

shifted above the 8 at the top of the keyboard so there is no lack of choice. The awkward two-finger access to the Escape is far from handy when it is so frequently used as the get-out key throughout the whole Psion package.

The numeric keypad is red and has the function keys mapped on to it, the Alt key being used to shift between the two. In conjunction with the Shift key the numeric keypad is also used to drive some of the telephone functions, and somehow the Caps Lock has got mixed in there too. There is one bright green key on the keyboard, Enter. This is unfortunately the same size as an ordinary character key, but it is within comfortable reach of the home keys — one up on the IBM PC — so touch-typists should adapt easily.

The two Microdrives perch over the keyboard in a housing that looks like a large bar of Toblerone. The system calls them L: and R:, standing for Left and Right. Memory is also treated as a file-storing device called M:. This is a great improvement on the long-winded MDV1 format that the QL insists on. However, when you power-up what is supposedly ICL Basic — and is in fact a minor revamping of Sinclair's excellent SuperBasic — the drives revert to their full QL names and the concept of M: disappears.

different processes, and the operating system has no automatic mechanism for rescuing isolated slivers. The only way to crunch memory is to save everything to tape and restore it again.

The result of this is that as long as you are not doing anything else and you are not trying to save any other files in memory you can reckon that Quill will throw in the towel with an out-of-memory message at around 5,000 words, so you can almost write a 10-page report single-spaced.

Long waits

It is possible to extend this size by overriding the default that makes Xchange store its files in memory, so larger jobs can be tackled if really necessary. However, you will have to put up with long waits during saving and loading because Microdrive activity takes over the machine entirely.

I also found that, as on the QL, Quill sometimes gets into a twist offering a message like

Unable to start Quill
Press Space to continue
Press Esc to abandon Quill

Pressing Space simply repeats the error message, and abandoning Quill is the only course of action. Even this is not enough as Quill's data area in memory is damaged and the only way to repair it is to abandon the whole Psion package and reactivate it.

Quill on the OPD is strictly a glass-typewriter word processor: that is, simple to get to grips with but inadequate for extensive text editing. I cannot help feeling these are still early days for games house Psion in its venture into serious software, for the whole package has some very

curious shortcomings that betray this inexperience. For example, there seems to be no way to make a copy of a portion of text in Quill and send it out to another file.

I decided reluctantly that I would have to go back to my old machine to write this review, and was presented with the task of transferring the couple of pages of notes I had already gathered together in Quill. I felt confident that I would be able to transfer the text to a familiar environment should the need arise, presuming that if the worst came to the worst I could always send the text down to Telecom Gold over the built-in modem and retrieve it again on the other machine.

However, the worst did come to the worst because as with the telephone directory, the OPD offers no help in

uploading or downloading data from another machine. So I turned to the modem link. I was flabbergasted to discover that there is no way of transmitting text created in Quill over the modem, and that it is equally impossible to use Quill to edit text received in the same way.

In the end I got the notes across, using some RS-232 jiggery-pokery to pretend to the OPD that the Almarc was a printer. It was none too soon. Later that afternoon I discovered the screen was displaying an attractive flickering pattern like psychedelic wallpaper. Something had zapped the RAM. Both telephone lines had died, and the RAM data, the telephone directories and the last traces of my review notes had all evaporated.

Conclusions

● As an intelligent phone the OPD has a great deal to offer. Voice contact is highly automated, and the best features of the system work well. Connection with such widely differing systems as The Source and Prestel is simply a matter of menu selection.

● ICL makes much of the multi-tasking capability, but this turns out to be strictly limited. Memory can be a problem: of the 128K theoretically available, 32K is reserved for the screen and further large inroads are made during use.

● Design limitations on the multi-tasking are curiously set. For example, if the phone rings while you are formatting a tape, the format is instantly abandoned. I kept running into design and memory limitations on the multi-tasking that left the OPD with no significant advantage over single-tasking implementations of the Xchange suite.

● The overall software ergonomics are dismal. Psion's contribution on this front is moderate but not inspired. ICL's numerically selected menus betray a main-frame mentality that the company will have to shake off if it wants to stay in the micro market.

● Psion's software and ICL's software seem to have been written on different planets, from the point of view of both function and ergonomics. It's a pity that Psion's database and spreadsheet cannot call on the system date. It is astonishing that Quill has absolutely no access to the data transmitted and received over the modem.

● The basic project is a sound design idea and a promising marketing proposition. The formidable list of shortcomings that currently severely limits the use of the machine can be whittled down, given the will and effort from the ICL team. 

THERE ARE THREE main reasons why the Tandy 1000 is important. It is IBM PC compatible. It is cheap: prices start at well under £1,500. And it will be sold in High Street shops, not in the slightly intimidating specialist dealers.

In the 1000, Tandy has produced a truly universal computer. Not only does it outperform many of the micros currently used in large corporations and small businesses, it is ideal for the one-person business and for business/home use.

It can become a major contender in this market, as it will be sold through Tandy's own High Street computer stores. While many ordinary people may be overawed by specialist computer dealers' shops, no one is scared of going into Tandy.

The 1000 is largely compatible with the standard IBM PC. There will undoubtedly be many badly behaved packages that it does not run, but it does run the Microsoft Flight Simulator, Lotus 1-2-3, Multiplan and other popular programs.

Joystick and colour

Unlike ordinary IBMulators, the Tandy is also designed to be largely compatible with the IBM PC Junior. Thus it has built-in colour graphics and other extras such as a light-pen port and two joystick ports. This means it can run the very large range of IBM PC games and educational programs, including most of the American Top 30

However, many users will find that most of their needs are satisfied by Deskmate, the integrated software package supplied free with the Tandy 1000. Deskmate offers word processing, a spreadsheet, a filing program, telecommunications and a calendar/diary program on a single disc. It will be reviewed in depth next month.

The Tandy 1000 is built in Fort Worth, Texas, and a U.S. production sample was supplied for this review. There is no reason to believe U.K. machines will be substantially different.

In appearance, the 1000 is very like the well-known Tandy 2000, but much smaller. In the basic version the 1000 has two parts: a system box with a Teac 5.25in. floppy-disc drive, and a keyboard. You have to add either a colour or monochrome monitor. You can have a second built-in disc drive, and one was fitted to the review machine.

The system box contains a single board with 128K of RAM and an Intel 8088 CPU. It has a keyboard port, two joystick ports

TANDY 1000

Has the universal computer arrived? Jack Schofield discovers that Tandy's cheap, colour IBM compatible may be coming close.

and a red Reset button on the front. There are ports for a parallel printer — actually, this is just an edge connector — a light-pen, RGB monitor, and composite video/audio output on the back. There is no RS-232C port, so it will require an extra expansion card from Tandy if you want to add a modem.

No parity checking

Removing the top of the case reveals the motherboard, which is mostly hidden under the well-shielded disc-drive enclosure. However, it includes both the colour-graphics and floppy-disc controller circuitry, both of which are on separate expansion cards in the IBM PC itself. There is apparently no 8087 co-processor socket, and no sign of either a DIL switch or a DMA chip. The memory is made up of 16 64Kbit RAM chips, with no ninth row of chips for parity checking as on the IBM.

The main board has three free expansion slots, claimed to be IBM compatible. The system box is too short to take standard 14in. IBM cards, so clearly the compatibility is limited. The review sample had a Tandy-made RAM expansion card already fitted. This had several interesting features: it had 128K of RAM soldered directly to the board, plus sockets for a further 128K; it also had a DMA chip to

Specification

CPU: Intel 8088
RAM: 128K, expandable to 640K
ROM: 16K
Storage: 360K disc drive
Keyboard: 90-key detached with numeric keypad, 12 function keys, four cursor keys; LEDs on Num Lock and Caps Lock keys
Sound: one voice via internal loudspeaker; three voices via external speaker
Interfaces: RGB and composite video, parallel printer port, light-pen port, two DIN-plug joystick ports
Expansion: three IBM PC compatible expansion slots, limited in length
Software in price: MS-DOS, GWBasic, Deskmate integrated software
Dimensions: 415mm. (16.3in.) by 335mm. (13.1in.) by 150mm. (5.9in.)
Price: single-floppy system with keyboard, £1,099; monochrome screen, £159; colour monitor £499; second disc drive, £269; all prices exclude VAT
Supplier: Tandy, Tameway Tower, Bridge Street, Walsall, West Midlands. Telephone: (0922) 648181
Availability: U.K. deliveries scheduled for the end of April

speed up memory access with larger amounts of RAM.

The single-board construction obviously reduces cost at the expense of flexibility. Dropping the IBM's parity checking is another obvious cost-cutting measure. That said, the quality of the design and construction appears to be very high.

The keyboard is the one part of the Tandy 1000 that causes alarm. It is just not the same as the IBM PC version. It has more keys, and many of them are in different places. There are 12 function keys instead of 10, and four separate keys for cursor control.

Some changes represent minor improvements. The Caps Lock key has been resited, and given an LED; the Backslash key has been moved from its ill-conceived position between the left Shift and Z. Also,

Screen mode options

Mode	Colours	Resolution	Text width	RAM used
0	16	80 x 25	40 or 80	2K or 4K
1	4	320 x 200	40	16K
2	2	640 x 200	80	16K
3	16	160 x 200	20	16K
4	4	320 x 200	40	16K
5	16	320 x 200	40	32K
6	16	640 x 200	80	32K

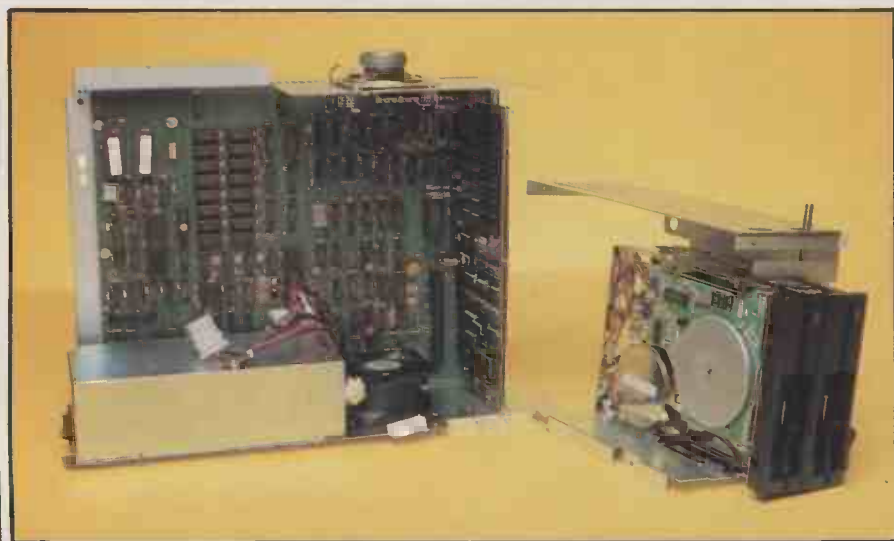

Inside the machine virtually all the components fit onto a single large motherboard.

the keyboard plugs into the front of the system box, instead of the back.

As the IBM PC keyboard is software definable, rather than hard-wired, there is no real reason why the IBM PC layout should be followed exactly. However, the Tandy 1000 keyboard clearly looks, feels and is different. With some packages this may reduce the level of IBM PC compatibility. The alphanumeric keys seem to be the same, but who can tell what effect function keys f11 and f12 will have in packages not designed to use them?

Keys feel good

In absolute terms, however, the Tandy 1000 keyboard is very good. The keys are sculpted and properly sprung, and a touch-typist is likely to prefer them to many other compatibles.

There is 32K of video RAM, though only the two 16-colour higher resolution screen modes actually use all of it. The standard character set is identical to the extended ASCII of the IBM PC.

No problems were encountered running a small selection of software from IBM PC discs, although the Microsoft Flight Simulator and Sidekick would only produce monochrome. Lotus 1-2-3 ran happily in colour, and ignored f11 and f12. TK!Solver also ignored the keys; Multiplan recognised them but responded firmly with "illegal option".

The 1000 started the IBM PC diagnostics disc, though it could only find 240K of the 256K of RAM installed, and never actually got to any of the diagnostics routines. This suggests that, in the end, the 1000 will prove adequately IBM PC compatible, rather than outstandingly so.

Inferior display

Unlike the best compatibles, such as the Olivetti and Compaq models, the Tandy 1000 does not provide a combined monochrome/colour screen display. In fact it does not offer the equivalent of the IBM's green screen at all, just the equivalent of the colour-graphics adaptor. The point is that the IBM provides exceptionally good stability and legibility on the monochrome screen. At the lower resolution of the colour display the characters are not very tightly formed, and this is how the Tandy displays all text.

The Tandy 1000 has many advantages over the IBM PC, and it provides more for a lot less money. It certainly has the edge over the normal IBM PC in providing colour-graphics facilities. However, for intensive word processing or spreadsheet use the less fatiguing display of the IBM green screen takes a lot of beating.

For many people this factor may not be decisive, and this is where the Deskmate software might tip the balance. Good integrated packages commonly cost from £200 to £500, and the fact that it is included with the machine makes the 1000 an attractive proposition. Just how good the software is we will be investigating next month.

WYSE PC

IBM PC COMPATIBLES do little to raise the blood pressure these days, and a new machine needs some special claim to fame if it is to turn any heads. In the case of the Wyse PC the company has chosen to package the machine in a box little thicker than the average software manual. It is an impressive feat of engineering, but unfortunately the slimness of the case does little to improve the machine's overall ergonomics. The unit is so low that with the keyboard placed on the desk in front of the main box access to the disc drives is impeded.

The review machine was an almost "full-house" colour version with 10Mbyte hard disc and 512K RAM. The Seagate hard disc is mounted to the right of an Epson 360K floppy drive of the type fitted with a rather cumbersome locking button. A totally unprotected on/off rocker switch is also rather foolishly on the front, where the rear edge of the keyboard could easily knock it into the Off position.

On the rear panel the cooling fan outlet, mains sockets and other interfaces are tidily arranged. An auxiliary supply for the monitor is included, so only one mains cable is required. The Wyse is well endowed with interfaces: in addition to the monochrome connection, the standard machine has two RS-232C ports and one parallel port. This is a far better spec than the IBM, where even a single RS-232 port is an extra. The only criticism is that the parallel port is fitted with a non-standard socket.

Well laid-out inside

The Wyse is manufactured in Taiwan, but it would be a mistake to assume that it is of second-rate construction. The reverse is true, a fact which becomes apparent immediately the robust case is removed. Although there is not a lot of room the internals are beautifully finished and well laid-out. The power supply occupies one-quarter of the machine on the right-hand side, and the motherboard takes up all the remaining space on the base plate. Above the motherboard are the disc drives and expansion chassis.

It is rather sad to have to report that the Wyse only uses the standard Intel 8088 CPU running at the same conservative 4.77MHz as the IBM. It does seem like a missed opportunity not to have opted for the full 8086, or at least an 8088-2 running at a faster speed. The standard Wyse is supplied with 256K of RAM, which can be expanded to 512K without using up either of the precious expansion slots.

One of the penalties of the Wyse's trendy low-profile design is that expansion is rather awkward. The expansion cards have to lie flat over the motherboard, so

Compact, elegant and thoroughly compatible — what more could anyone want from an IBMulator? Robert Piper puts this handsome 8088-based desk-top machine through its paces.

there is only room for two slots on the basic machine. The hard-disc colour model has no vacant slots, as the hard-disc controller and colour/graphics card consume a slot each.

Wyse tackles the problem by offering a multi-function backplane which not only increases the total memory to 512K but also adds a real-time clock with battery backup. For £320 you can also buy a separate four-slot expansion unit which connects to an expansion-bus controller card occupying one slot in the main unit. For a net gain of three slots this does

Specification

CPU: Intel 8088 running at 4.77MHz
RAM: 256K expandable to 640K
ROM: 8K ROM bootstrap and diagnostics
Dimensions: system unit 476mm. (18.75in.) by 368mm. (14.5in.) by 63.5mm (2.5in.)
Keyboard: 83-key IBM layout, 10 function keys
Mass storage: two 5.25in. 360K floppies, or one 10Mbyte hard disc plus one 360K floppy
Interfaces: two RS-232C serial, one parallel
Prices: with dual 256K floppy discs, £1,925; one floppy and 10Mbyte hard disc, £3,400; monochrome monitor, £250; colour monitor and card, £795; backplane extension, £465; expansion chassis, £320; all prices exclude VAT
Manufacturer: Wyse Technology, 3040 North First Street, San Jose, California
U.K. distributor: RTS Technology Ltd, Unit 12, St. Pancras Commercial Centre, 63 Pratt Street, London NW1 0BY. Telephone: 01-267 7541

Basic Benchmarks

The table shows the time in seconds to run the standard Basic routines — see *Practical Computing*, January 1984, page 102. With the same CPU as the IBM PC, the Wyse PC is just slightly faster.

	BM1	BM2	BM3	BM4	BM5	BM6	BM7	BM8	Av.
Wyse PC — 8088	1.3	4.7	10.2	10.5	11.4	20.4	31.8	33.8	15.5
IBM PC/AT — 80286	0.5	1.9	4.6	4.7	5.2	9.1	14.6	13.5	6.8
Olivetti M-24 — 8086	0.5	2.0	4.6	4.7	5.2	9.4	14.8	16.1	7.2
IBM PC — 8088	1.3	4.8	11.8	12.2	13.4	23.6	37.6	36.6	17.7

seem an unnecessarily cumbersome and expensive way of expanding a system. The expansion unit is designed to sit under the main processor box, which does give the added bonus of raising the disc-drive slots to a more practical position. The Wyse can be fitted with the Intel 8087 arithmetic co-processor, if required.

The keyboard closely follows the IBM layout, with one commendable exception: the three function, QWERTY and numeric keypads have been separated by about 15mm. Unfortunately the Wyse also perpetuates some bad aspects of the IBM keyboard. There are no LED indicators on the Num and Caps Lock keys and no separate entry key for the numeric pad. There is a robust tilt bar which can be flipped out to raise the rear edge of the keyboard if required. I found the key action acceptable, but it does not have the same substantial feel as the IBM.

Futuristic looks

A striking appearance has now become something of a trademark for the Wyse monitors. They boast a very futuristic, angular look which makes them seem a lot less bulky than they actually are. Both the monochrome and colour monitors adopt the same philosophy in their design and feature 14in. screens instead of the more conventional 12in. variety.

A tilt/swivel base, which costs an extra £21, fits into an off-centre retaining recess on the top of the PC box. A single edge-wise brightness control is cleverly concealed on the lower right-hand corner of the screen bezel. Wyse monitors are interchangeable with IBM versions and offer a very similar performance. Text appears a little grainy, but this is more by virtue of the larger display than any intrinsic hardware fault. Sitting further from the screen should get round this problem. Colour, graphics and screen-update performance are all up to the IBM standard.

The MS-DOS version 2.11 supplied with the Wyse is very much a standard implementation which includes all the usual utilities and no extras. Rather strangely, however, the DiskCopy command does not format as well; this operation has to be

(continued on page 82)

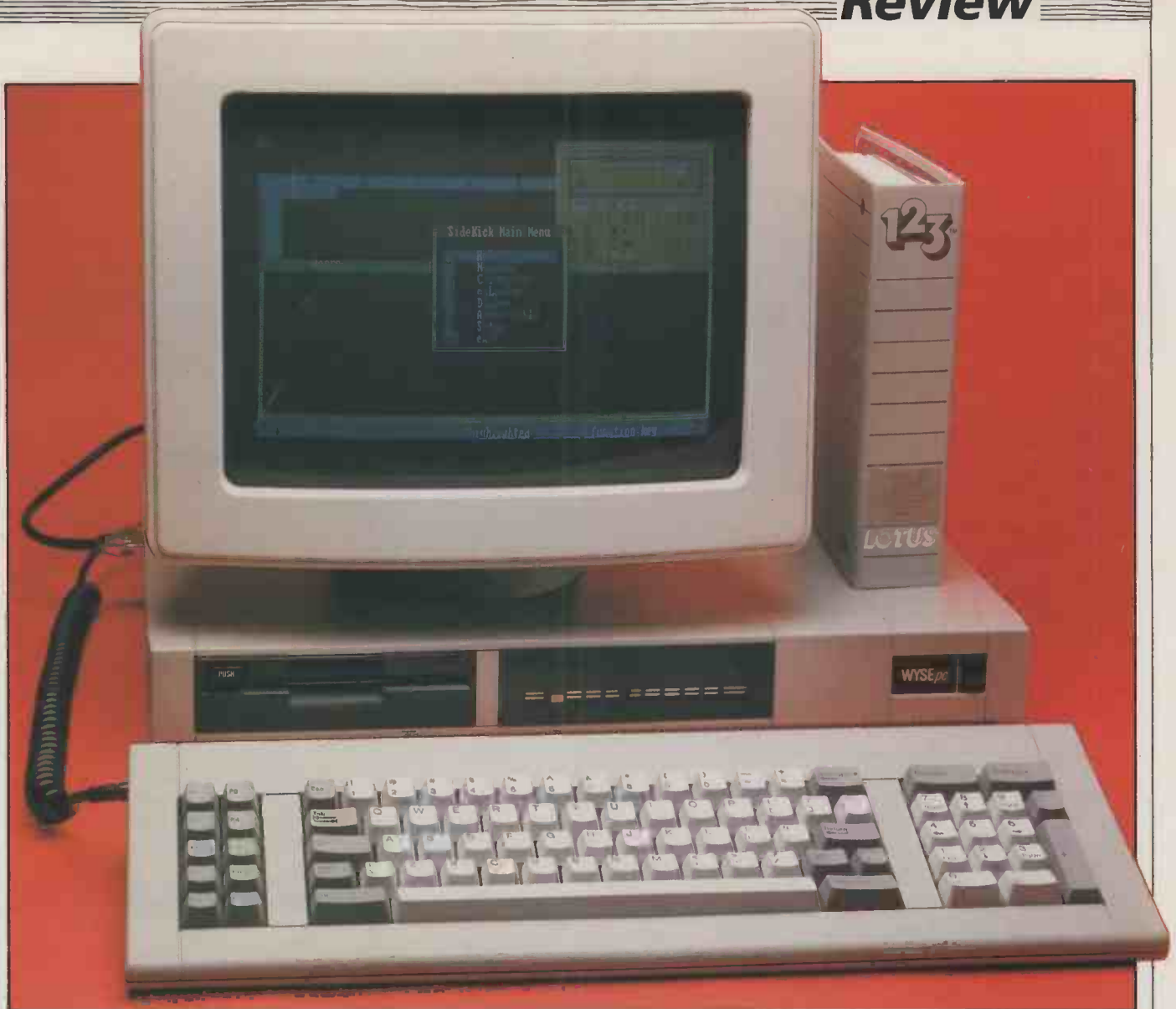

Above: The Wyse PC shown running standard IBM versions of Lotus 1-2-3 and Sidekick. The screen fits into a recess which is offset to the left; the free area on the right is where the power supply is sited internally.

Right: Inside the Wyse PC. The power supply and fan are on the far left, and the hard disc in the middle over the main board. Accessory cards, which would normally be upright and run front-to-back, here lie flat and run from side to side. The topmost card is the colour-graphics adaptor, which feeds the video signal out of the side of the system box. Ports on the back are: power point for monitor, monochrome display, Centronics printer, two RS-232C and keyboard.



Bagshaw Benchmarks

The table shows the time in seconds to run 14 Benchmarks designed by Eric Bagshaw of the National Computing Centre to show the speed of loading programs and making disc accesses — see *Personal Computer World*, November 1984, page 180. The three machines here were all tested using the 10Mbyte hard discs fitted.

	BM0	BM1	BM2	BM3	BM4	BM5	BM6	BM7	BM8	BM9	BM10	BM11	BM12	BM13	Total	Rank
Wyse PC	20	9	10	15	3	20	10	25	11	5	6	76	44	13	267	3
Apricot XI	16	6	7	11	7	26	1	27	2	4	9	50	20	6	192	1
IBM PC/XT	19	5	19	15	3	22	8	27	8	3	3	76	31	15	254	2

(continued from page 80)

carried out separately. There are also some limitations on the use of the Mode command, but they are unlikely to trouble many users.

Microsoft's GWBasic interpreter is included on the system disc. As well as GWBasic itself there is a batch file called Basica, which simply calls up GWBasic, so that any calls IBM software may make for Basica can be met.

The first aspect of the Wyse you are likely to notice is the amount of noise it makes. The diminutive fan, the floppy drive and hard discs all contribute to the din, but whether it will still be audible above the general mayhem of the average office environment is doubtful.

To all intents and purposes, the Wyse PC performs just like an IBM PC. The Basic Benchmark tests BM1 to BM8 average out to 15.5 seconds, which is marginally faster than the IBM. The time taken reading and writing to disc is likely to be of more serious significance in practice so we also ran the Bagshaw Disc Benchmarks. In these tests the Wyse turned in a performance which was to all intents and purposes identical to the IBM PC/XT's. The Apricot XI is significantly faster than both of them, romping home in around 190 seconds.

Compatibility with IBM software is excellent. The Wyse PC ran every package we tried without any problems. Even some of the more sophisticated packages with

complex copy protection loaded up and ran without any difficulties. The only problem we encountered was with Microsoft Word version 1.1, which loaded and ran as normal but displayed a rather strange border around the text-entry screen.

Prospective customers can choose any package intended for use on the IBM confident that there will be no niggling compatibility problems. Wyse itself has compiled a list of 250 packages tested on its PC. They include famous names like WordStar, Lotus 1-2-3 and Symphony, dBase II and VisiCalc.

The Wyse PC will be distributed and supported in the U.K. by RTS Technology. The warranty period is a mere 90 days — hardly competitive in this day and age of reliable electronics.

Two double A5-format manuals are provided: a combined user guide and operating-system guide, and a separate GWBasic reference manual. The user manual is divided into eight sections covering every aspect of operation from "Getting Started" to "Systems Error Messages". There are several appendices, one of which gives some honest guidance on potential compatibility limitations. Coverage is good, but the manuals would have been improved by being bound more robustly. The GWBasic manual is best considered a reference book, although chapter 1 does deal with the rudiments of programming.



The drive slots are so low down that the keyboard inhibits access.

Conclusions

● As an IBM PC look-alike the Wyse PC is hard to fault. It is pleasing to look at and well made, and is compatible to a high degree with the IBM machine. Documentation is above average.

● The low-profile processor box looks superb but detracts from the functional efficiency of the machine. Access to the disc drives is restricted and hardware expansion is made more expensive than it is with more conventionally designed machines.

● It is regrettable that a faster processor has not been built into such a latecomer to the PC-compatible market. There are now faster machines which offer equal levels of compatibility at a similar price to the Wyse. PC

Have you put a **CLIP** in your Winchester?

CLIP — Compressed Library Interchange Program

CP/M CP/M-86 PC DOS MS DOS £95.00

- **Backs up a Winchester on to floppies.**
- **Compresses text or data to less than half size.**
- **Large files can span multiple discs.**
- **Selective backup or retrieval, on an inclusive or exclusive basis.**

CLIP has no equal in reputation, convenience, power or economy.

EFFORTLESS BACKUP

You can save commands for later use, or type commands directly.

CLIP has its own menu, with seven prepared commands. Customise the commands if you wish, or edit the menu text with a word processor. Or keep the standard forms. All your housekeeping — save/restore/review — by pressing two keys.

CLIP comes standard with Winchester systems supplied by **British Telecom, Olympia, Cifer Systems, Research Machines and Philips.** And is highly recommended by other major manufacturers



KEELE CODES LTD

University of Keele, Keele, Staffordshire, U.K. Tel: (0782) 629221 Telex: 36113

All prices excl. VAT, post free in U.K.
Most popular disc formats from stock.

● Circle No. 119

Electronequip

(Authorised BBC Micro Dealer, and Econnet service centre),

*EPSON

RX-80FT £225.25 + VAT

FX-80 £320.88 + VAT

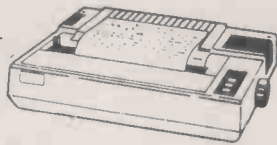

Printer price includes paper and BBC cable
Screen dump rom available for £11.50

*

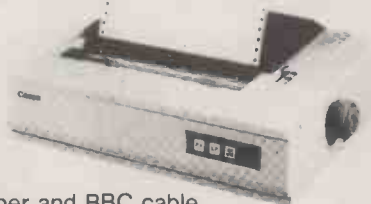

Printer price includes paper and BBC cable
Screen dump rom available for £11.50

VOLTMACE JOYSTICKS

*10% off list prices



		Discounted price
JSVOLT14	Voltmace Delta 14B Joysticks	inc. VAT 13.46
JSVOLTAD	Voltmace 14B/1 Adaptor Box	13.36
JSVOLT3B	Voltmace Delta 3B Twin Joysticks	18.09

SIDeways

SIDeways FITTED

"SIDeways" rom board for BBC Micro. No soldering required

£33.44 + VAT



NORDMENDE

14" TV/Monitor
£173.04 + VAT



BBC MODEL B £359.10 inc VAT

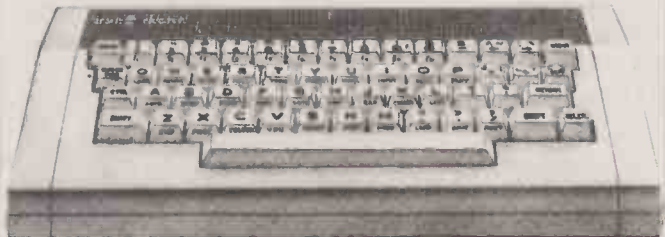

Electronequip is an authorised Acorn service centre and has been an Acorn dealer since the introduction of the Atom. Our demonstration facilities include 20 station Econnet and Torchnet systems.

	Ex VAT	Inc VAT
ANB02	BBC Model with Econnet Interface	389.14 446.00
ANB03	BBC Model with Disc Interface	409.14 469.00
ANB04	BBC Model B with Disc & Econnet Interface	450.01 516.00
ANC01	6502 Second Processor	174.35 199.00
ANC04	Z80 Second Processor	348.26 399.00
ACBBITST	Acorn Bit Stik (ANF04)	327.39 376.50
ACBTELET	Teletext Receiver (ANE01)	195.65 225.00

3" Micro Disc £89.00 (inc. VAT)

Disc Interface & Drive
£181.30 (inc. VAT)

Micro Disc Drive for the BBC Micro

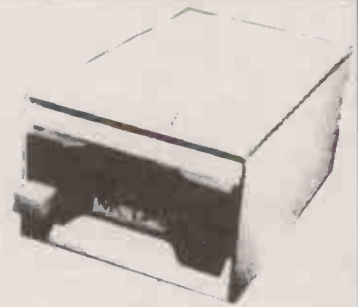

The Micro disc drive offers a method of low cost quick access to programs. The drive is essentially a small version of a 5¼" disc drive and offers similar features to the larger drive. The data is stored on a 3" disc, this is enclosed in a protective hard plastic cassette which features a write protect switch. The micro drive requires the standard Acorn disc interface, but a new disc filing system rom. Acorn DFS may be exchanged for the micro DFS for £2.30. The new micro disc filing system can read and write to Acorn DFS discs. Thus if a 5¼ inch and a micro floppy were connected on the same cable files could be transferred between them.
Capacity: 80.64 K bytes **Transfer Rate:** 125k bit/s.

All offers subject to availability
Prices subject to variation without prior notification
Prices for monitors & printers include BBC cable
TRADE ENQUIRIES WELCOME
Access & Barclaycard Accepted
Large Stocks — 24 Hour Despatch Carriage 46p

BRANCHES
MAIL ORDER: 36-38 WEST STREET
FAREHAM, HANTS. (0329) 230670
SHOP/TECHNICAL: 59 WEST STREET
FAREHAM, HANTS. (0329) 230671
KINGS LYNN: 17 TENNYSON AVE. (0553) 3782



Electronequip

BBC

36-38 West Street, Fareham, Hants (0329) 230670

The most famous name in word processing is now attached to a new product for the IBM PC. With so many competing programs now available, Roger Cullis assesses the newcomer's chances of living up to its predecessor.

MICROPRO HAS TAKEN a leaf out of the detergent manufacturers' book. Although the name on the package stays the same, the new, improved automatic word processor inside is a completely different product.

WordStar dates from the days when computers were not endowed with large memories, and so it was designed to use the minimum amount of RAM. Modules such as Help screens were kept on disc and loaded in as overlays when required. The result was painfully slow, and you waited for what seemed like years for the computer to complete its disc accesses. Another difficulty was that WordStar was hard to learn, since every operation involved you having to press a multiplicity of keys.

Neither of these shortcomings prevented WordStar becoming a runaway success. Over 1.25 million copies have been sold worldwide, and maybe four or five times as many pirate copies are in circulation. Like other authors of a successful package, Micropro has had to tread a careful path between the devil and the deep blue sea: to choose between frequent and major updates which keep it abreast of the latest developments, or to maintain the uniformity and freedom from change beloved of dealers and end-users. In the past Micropro has opted firmly for stability.

New features

In WordStar 2000 it has produced an entirely new word processor. The aim has been to keep all WordStar's best features and to add new ones where required. It is written from scratch in C on a Unix-based system. This approach should facilitate porting to new processors, but WordStar 2000 has so far only been implemented on the IBM PC. Old-fashioned WordStar will continue to be sold alongside the new product for this machine as well as for the eight-bit micros for which WordStar 2000 is not available.

WordStar 2000 comes in a bulky package which includes four manuals entitled *Installation Guide*, *Getting Started*, *Training Guide* and *Reference Guide*; their respective thicknesses form a Fibonacci series, each one being approximately equal to the sum of its



WORDSTAR 2000

Specification

WORDSTAR 2000
Maximum file size: 8,192,000 bytes
Number of lines that can be sorted: 150
Right margin: cols 10-240
Left margin: cols 1-70
Lines per page: 3-500
Maximum number of characters in locate/replace string: 40
Maximum number of founts: 8

CORRECTSTAR
Main dictionary: over 65,000 words; 310,912 bytes
Personal dictionary: up to 1,500 words
Maximum word length: 32 characters

MAILMERGE
Maximum variable length: 31 characters
Maximum file size: 8,192,000 bytes
Number of files you can chain print: unlimited

SYSTEM REQUIREMENT
Operating system: PC-DOS v.2.0, 2.1 or 3.0
Memory: 256K
Discs: two, at least 360K each

two predecessors. There are six discs: Installation, Program, Dictionary, Conversion and two Tutorials — the last so that you do not have to read the four manuals.

The spiral-bound manuals themselves are clearly written and well presented, with strategic use of bold printing and rubrics to make them easy to follow. You also get a plastic overlay to clip on to the keyboard of your PC to remind you of the default

settings for the various function keys.

Most of the discs can be readily duplicated. The program disc has a built-in counter which only allows you to make three copies, but this is not a serious limitation since you can recover the copy and reset the counter if your working disc wears out. It does mean, however, that you cannot transfer the program to a RAM disc to gain enhanced operating speed.

Installation is a simple two-part procedure, requiring eight blank formatted discs or alternatively 2.1Mbyte of hard-disc space. First, you make backups of discs 2 to 6 using the normal DOS Copy program. Then you insert disc 1 in drive A and type

ins-1 floppy

or

ins-1 hard

according to your disc system configuration. After this you simply follow the on-screen instructions.

After your working copies have been made, the second part of the installation process sets up the default system configuration. This enables you to choose colour or monochrome displays and set up the features of a graphics card. Printers can be chosen from a wide list and you can select features such as alternative founts, print colour and pitch.

Only one printer driver can be accommodated on the program disc, so you cannot easily use, for example, a dot-matrix for drafts and a daisywheel for the final copy. An Advanced Modifications

Left Page Annotations:

- Annual Sale ← Header (^OH)
- LETTER-PERFECT PRINT SHOP ← Underline (^PU)
- It's time once again for stocking up on business cards, memo pads, printed stationery, and other custom-labeled business supplies. This year we are offering a 10% discount on all orders of \$25.00 or more. ← Justify On (^OJ)
- Here are some samples of typefaces you can request: ← Single-space (Format and ^PH)
- Our service is fast, reliable, and accurate. OUR SERVICE IS FAST, RELIABLE, AND ACCURATE. Our service is fast, reliable, and accurate. ← Change font (^PF)
- You can select paper in any of these colors: ← Sort (^BS)
- Antique white ← Footnote reference (^ON)
- Lemon yellow
- Pale blue
- Rose ← Change left margin (^TL) or indent (^TI)
- LIMITED OFFER, WHILE SUPPLY LASTS ... ← Change right margin (^TR)
- Bond paper in pale blue or yellow. 14 per sheet with letterhead! ← Strikeout (^PS)
- Overstrike (^PO)
- HURRY AND TAKE ADVANTAGE OF THIS SPECIAL OFFER! ← Double underline (^PN)
- 1000 business cards \$19.95
- 2 dozen memo pads \$11.95
- 2000 sheets, letterhead paper \$19.95
- 2000 envelopes \$39.95
- Tab stop (^TS)
- Total \$91.80 (plus 6% tax) ← Arithmetic (^BA)
- NOTICE OF POLICY CHANGE
- Beginning June 1, we will change our payment terms from net 60 days to net 30 days. ← Double-space (^PH)
- ← Justify Off (Format and ^OJ)
- Sale ends August 1, 1985 ← Footer (^OF)
- 1 ← Page numbers (Format, ^OF, and ^OA)

Right Page Annotations:

- New page (^OP)
- Annual Sale ← Header (^OH)
- Here's a list of just a few of our most satisfied customers who have kindly allowed us to print their names: ← Hyphenation (Format and ^O-)
- Dentoni "Always 72" Home Insulation Company
- Higgins Hardware
- CO Mineral Water Bottlers ← Superscript (^P+)
- We are anxious to do business with you. Come in, phone, or mail your order to: ← Subscript (^P-)
- Letter-Perfect Print Shop
- 4444 Fourth Avenue
- Great Falls, Montana 59401
- (406) 511-4444
- Insert boilerplate text such as your address; type short form only (^KD, ^KU)
- 1. 2% additional charge ← Footnote (^ON)
- 2 ← Page numbers (Format, ^OF, and ^OA)
- Sale ends August 1, 1985 ← Footer (^OF)

Sample pages showing WordStar 2000 commands.

phase permits you to adjust a number of WordStar 2000's default settings, and lets you do things like reprogramming the function keys. All the installation is menu driven — a far cry from the original WordStar, which required you to be expert in assembler to set up even relatively minor modifications.

Five formats

Starting up is simple: type WS2 to boot WordStar 2000, E for Edit when the opening menu is displayed, and away you go. Following normal conventions file names consist of eight characters plus extension. For each file, you can choose one of five formats: justify, memoform, manuscript, normal or ragged. Alternatively you can design your own for the specific application. The advantage of coupling a format with a file is that next time you come to edit it no time need be spent on setting items such as tabs and margins. Format files are set up by answering a standard series of questions about the top margin setting, lines per page, line spacing, etc.

Text may be entered in either Insert and Overtyping mode. Cursor movement is achieved either by using the cursor keys or Ctrl-C — C for cursor — followed by a mnemonic character: B, beginning; E, end; H, home; L, left; R, right; T, to specified character. Deletion also follows this convention. Ctrl-R, for remove, is followed by similar mnemonic characters. The cursor can also be moved to a specified page number.

A major new editing command, Ctrl-U for Undo, permits you to reverse the previous deletion and replace the characters removed. Fast typists will find this invaluable. When the session is finished, the prepared text is saved by Ctrl-Q for quit.

The screen display commences with a status line which shows the editing command currently in use; the name of the file you are editing; the page, line and column number of the cursor; Insert/Overtyping option setting; and vertical/horizontal arithmetic mode setting. The menu area shows the possible choices of action. Below this, instructions tell you how to use the menu. A ruler line shows the margins and tab stops, and a flag column at the far right of the screen contains an entry-type indicator — end of paragraph, end of text, page break, etc. Your text appears in a window; up to three may be in use at any one time.

Not WYSIWYG

Unlike WordStar, where what you see is what you get, WordStar 2000 always displays text with a ragged right-hand margin. I hesitate to say that I can see the justification for this, but it does have the advantage that you can see where you have put hard spaces. A serious shortcoming is that, if you are not using a 10 character/inch printer the text does not match up with the ruler line.

One of WordStar 2000's powerful

features is its ability to manipulate blocks of text which are marked with

Ctrl-B B

at the beginning and

Ctrl-B E

at the end. A marked block can be moved or copied to another location, or removed or written to a file. In addition, an existing file can be read in as a block to the cursor position. This can be very useful if you want to read in skeleton text for modification. The block transfer can be reversed with the Undo command.

Another feature of the block commands is the ability to sort and to carry out elementary mathematical operations. To commence sorting, WordStar 2000 is set in the Block Vertical mode with a

Ctrl-B V

command. The block is marked with standard block markers. A Block Sort command

Ctrl-B S

is issued and, depending on whether an A or D command follows, the lines within the block are sorted in ascending or descending ASCII order. For arithmetic, the appropriate symbol is added to the text, the default operation being addition. A decimal tab can be selected for currency calculations.

With an appropriate printer, commands may be embedded in the text to change the printing characteristics. Bold, underlining, subscript, superscript, strikeout,

(continued on next page)

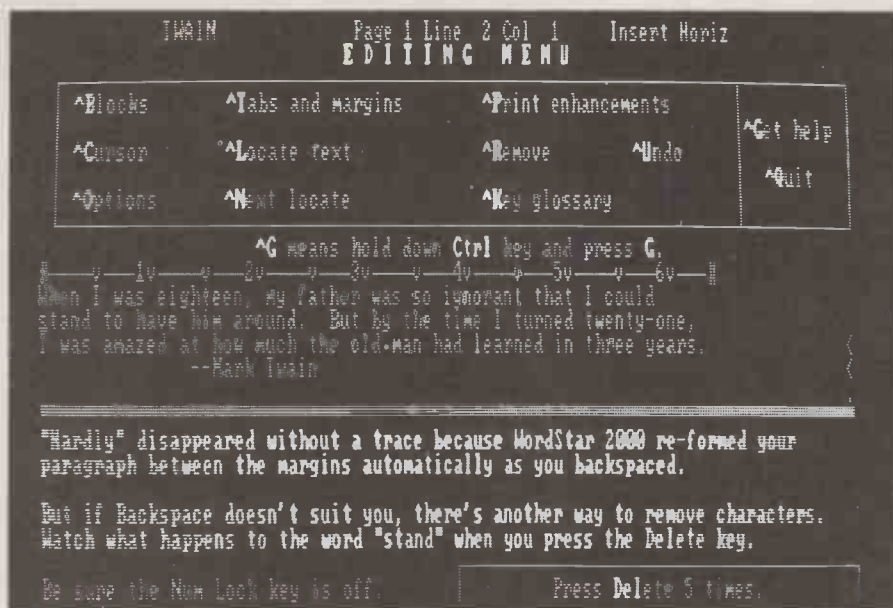

The editing screen displays a command menu and a ruler to show margins and tabs.

(continued from previous page)

emphasis, line spacing, typeface, ribbon colour and paper trays are features which may be selected. Selected words such as a title or a proper name may be linked together so that they always print on the same line.

The format file associated with an editing file when it is created carries the initial setting of margins and tab stops, but they may be reset in the body of the document. The ruler line display which shows their positions acts like a command tag for any other change in the text, such as the insertion of a superscript. Indents may be created and text may be typed in columns. On-screen formatting is instantaneous if the margins are changed.

Key glossary

For text which includes regularly used groups of words an abbreviated version may be used by constructing a key glossary which contains the corresponding long and short forms. The glossaries are stored in key files, each of which may contain up to 20 key definitions. A long form may include up to 560 characters and the corresponding short form from one to 15 characters.

WordStar 2000 includes a Typewriter mode, in which keystrokes are immediately echoed at the printer. This feature is useful for envelopes or filling in forms.

WordStar has always had the ability to spool printer output by allocating part of the available memory for this purpose. With much more memory now available, the opportunity presents itself to edit more than one document simultaneously or simply to display text for information. By using windows, WordStar 2000 permits you, for example, to type new figures into a spreadsheet, extract figures from another document, look up page numbers, or move paragraphs from a first draft to a reorganised second draft.

Only the document in the window with

the cursor may be edited, but the cursor can readily be moved from window to window. If you wish, more than one window may be opened in a single document, but the same limitations on editing applies. Text may be moved from one window to another using the block move facility.

You can mark pages with headers and footers, which may include page numbers if you wish. You can create a footnote at will. WordStar 2000 prints the footnote number in superscript in the text and the footnotes in consecutive order at the end of the text. On the screen the number is highlighted or coloured.

You can create forms by adding text to a format file, and it will be offered as an option with the other formats in the opening menu. Text may be typed in two ways, depending on how the form is to be used. One way is to leave adequate space for information to be typed, the other is to mark the blanks with a character and to type the information in Insert mode.

WordStar 2000 comes with Correctstar, a powerful spelling checker. Its 65,000-word dictionary is offered with English as well as American options. Individual words may be checked during an editing session, and when Correctstar finds a mistake it will suggest an alternative. You can check the spelling of a paragraph or the entire document, or if you have only changed a part of a document you can instruct Correctstar to bypass the remainder. The default dictionary can be supplemented by an extra personal dictionary which may contain names or technical terms.

Mailmerge is a feature of WordStar 2000 that lets you create master documents which can be used for a variety of printing tasks. It produces personalised form letters by taking information from various sources such as data files, operator input or other text files. You can use it to print two or more files consecutively to create a

Compared with WordStar...

New features

- Remove a sentence or paragraph without defining it as a block
- Restore the previous alteration
- Use preset formats, embed ruler lines
- Use up to three windows in the same or different files
- Mnemonic commands
- Pre-programmed function keys
- Short-form entry of key terms
- Go directly to specified page
- Perform simple arithmetic
- Sort blocks of numerals or text
- Typewriter mode
- Automatic reformatting when you change margin settings
- Boldface and underline screen display
- Underline between words
- One-command indenting of both margins
- Add footnotes
- Use up to eight type founts
- Select page-numbering position
- Select paper trays
- Select print enhancements

Exchanging files

WordStar 2000 has an automatic facility to convert WordStar files to the new format. It goes through the file, changing commands it recognises to the equivalent WordStar 2000 command. Dot commands which have no equivalents, and other WordStar commands not translated, are flagged with explanatory comments. To complete the conversion it is necessary to go through the file, removing these flagged comments and making any further changes manually. A similar program is provided to change WordStar 2000 files to WordStar format.

continuous document, like the chapters of a book. You can produce a mailing list with alternative versions of a form letter, selecting your data according to preset criteria.

Conclusions

- WordStar 2000 is not WordStar — both the command set and the file structure are different. But like the original product it does a lot — it is a very complete word processor.

- At present WordStar 2000 runs only on the IBM PC and close look-alikes. It is easy to install and makes good use of the IBM function keys.

- Compared to other modern word processors running on the IBM PC WordStar 2000 is really not that exceptional. But Micropro has done as competent a job for 16-bit word processing as the original product did for eight-bit. It is probably enough to say that I liked it and would use it myself.

- WordStar 2000 costs £440 plus VAT. It is distributed by Micropro, Haygarth House, 28-31 High Street, London SW19 5BY. Telephone: 01-879 1122.



Mail used to be a sticky business.

Sticky indeed. Inconvenient too. But expensive mistakes were unusual. Now?

While communicating has got simpler, choosing the right system hasn't.

Enter the BRAID MAIL MANAGER. A quiet unassuming office assistant with a touch of pure genius.

Running on a standard office micro, the BRAID MAIL MANAGER speeds up and simplifies the whole process of message despatch and retrieval. All in the background of the PC's normal activities. Imagine the luxury of timed transmissions, automatic dialling and retry, automatic mailbox emptying, complete logging, and foolproof menu-driven operation. And into whatever service you choose, or direct from PC to PC.

All at the touch of a key. The BRAID MAIL MANAGER: tailor-made to your electronic

mail needs, and fully approved by British Telecom.

Get in touch with us right away, by telephone, telex or even old-fashioned pen & ink.

From now on you won't come unstuck.

Please send me details of the Braid Mail Manager.

NAME: _____

POSITION: _____

COMPANY: _____

ADDRESS: _____

TELEPHONE/TELEX NO: _____

Post to: Braid Systems Ltd, 130 Buckingham Palace Road, London SW1W 9SA. Telephone: 01-730 0736. Telex: 297218.

braid

**A Microcomputer Systems House
Specialising in Telecommunications**

dBase II lives on

Users of Ashton-Tate's established database package will continue to be well supported by third-party products, as Mike Lewis discovers.

WHEN Ashton-Tate released dBase III last year, a minor shock wave hit the dBase community. If, as seemed likely, the new product was to be the definitive database package for the years ahead, what would happen to the vast investment in dBase II applications and systems? Many thousands of newcomers to computing had struggled to master dBase II, and few of them could have relished the prospect of starting again with a new, incompatible language, however superior it might be. Worse, the new product was to be available to the MS-DOS and PC-DOS world only. Would the army of CP/M-80 users be left in the cold?

To find the answers to these questions, I have been talking to Ashton-Tate and taking a look at the sub-industry that has grown up in the shadow of dBase II. If the entrepreneurs and authors who flood the market with dBase add-ons, training aids, books and consultancy services are anything to judge by, there is still considerable faith in the future of the original dBase II. What is more, the people at Ashton-Tate's HQ are bending over backwards to reassure customers of their continuing support.

dBase II compiler

Perhaps the most exciting development of recent months has come from a small software house called Wordtech Systems. The company has answered the prayers of system developers by releasing the first-ever compiler for dBase II. This alone is certain to keep the language at the forefront of its field for a long time yet.

With dB/Compiler, dBase programmers can convert their applications directly to an executable form and then run them independently of dBase. This immediately gives rise to three main benefits, although there is a major snag too.

The first benefit is speed. In any programming environment, a compiled program will nearly always run faster than an interpreted one. This is because the time-consuming work of decoding the source program is done once only, during compilation, rather than each time the program is used. In Basic, it is not unusual for a program to run 20 times faster once it has been compiled.

Although the speed-up produced by dB/Compiler is less dramatic, you can still expect a healthy improvement in running times. Moreover, the compilation process is pretty quick, and you can compile and link an entire application — command files, report forms, format files and so on — in one pass.



I have compiled over 50 dBase programs and in most cases have found improvements of 25 percent to 50 percent. Large, complex programs seem to give the greatest savings. The main problem area is with tasks involving heavy computation, where compiled programs run only slightly faster, and in some cases slower, than the originals. This is partly because dB/Compiler performs all arithmetic to 30 decimal places, against 10 in dBase II. However this is not likely to cause too many difficulties because database applications do not usually involve extensive calculations.

You have to balance such time savings against a possible increase in space. With 16-bit versions of the compiler, the minimum size of an executable suite of programs is 90.6K, consisting of a fixed-

length root module and two overlays. In eight-bit environments the root is smaller but there is more overlay swapping. This arrangement works to your advantage if you have a large suite of integrated programs but it makes the compiler less attractive for small, free-standing command files.

The second benefit of dB/Compiler is confidentiality. A software house can distribute copies of its work without worrying about prying eyes discovering its secrets. Admittedly, previously they could achieve the same end by using Ashton-Tate's Runtime. This crunches dBase code to an unrecognisable form, but means spending £65 on a Runtime licence for each copy of the application sold.

And so to the third of the benefits: price. Once the software house has laid out £675 for dB/Compiler, it has no further royalties to pay and there is no need for it to supply its customers with dBase itself or a Runtime licence. Consequently off-the-shelf dBase applications are more attractive, which benefits the entire dBase community.

The major snag for software developers relates to copy protection. Every time you invoke dB/Compiler in a 16-bit environment you must do so from the original floppy disc on which it was supplied. You can then remove this disc and

dB/Compiler timings

Programs in dBase II will run much faster once they have been compiled with dB/Compiler, but the extent of the speed-up varies considerably from one type of program to another. In general, complex programs working on large databases appear to do well, especially if they involve heavy string manipulations. Routines with extensive calculations fare less well. Here are some typical timings in seconds, all of which were carried out on an Olivetti M-24, with floppy discs, under MS-DOS.

- T1. Update a database of 150 records and four fields. For each record calculate the square root of one of the fields, a two-digit integer, by iterative methods — five iterations — and place the result in another field. Display all values on the screen.
- T2. Update a database of 10 records and two fields. For each record, generate a Simplex code of one of the fields — 30 characters — and place the result in the other field. Display both fields on the screen.
- T3. Update a file of 150 records and 16 fields. For each record, calculate the mean of two fields and place the result in a third. Test the values of substrings of four fields and store the result as a logical value in a further field.

It takes dBase II and dB/Compiler 45 seconds to compile all of the above routines as a set of linked command files, and 56 seconds to link the above routines — this increases slightly with the size of the programs. The total size of the source files is 1,500 bytes, to which approximately 72K should be added for dBase II itself. The total size of the executable file and overlays is 93K.

	T1	T2	T3
dBase II	50	32	78
dB/Compiler	41	21	43

dSort timings

The following show how much faster the free-standing dSort program runs compared to the built-in Sort and Index commands. In each case, the database being sorted had 114 records, each of which was 207 bytes. The key field was 25 bytes. All tests were performed on a Superbrain with floppy discs; the timings in seconds do not include program invocation.

dBase internal sort command	115
dBase internal index command	80
dSort program	35

continue with a working copy, but if the original becomes worn or damaged you are well and truly stuck. I am fully alive to the arguments for anti-piracy measures, and I only mildly object to copy protection of luxury programs like spelling checkers. But if a software house commits itself to dB/Compiler, the product will be its bread and butter, and it will have to think very carefully before putting itself in this position. Happily, there is no copy-protection on eight-bit versions of the compiler.

There are a number of other snags with dB/Compiler, mainly arising from minor differences in the language supported, but most of them are easily overcome. In general, the compiler accepts all the language features of dBase 2.4, except those that are normally invoked only from the dBase dot prompt, such as Modify and Help, or the interactive forms of Create,

Append, Edit, etc. Also, it is not possible to use Debug, Echo, Step, Talk and the like — these are always disabled. Neither can you Peek and Poke or call machine-language subroutines.

The most serious difficulty I have had with the compilable language is the inability to use macros in the names of command files. I like to use a macro containing the drive designation as part of a file name. This simplifies the transfer of programs to machines with different disc arrangements. But this is impossible with dB/Compiler, since it must know at compile time where all command files, etc. reside. Fortunately, this restriction does not apply to databases or memory-variable files.

Given the undoubted boost that dB/Compiler will give to dBase II, Ashton-Tate's aloof attitude towards it is surprising. A spokesman said that the company acknowledges the existence of the compiler but has decided not to recommend it, which is especially strange considering that it is almost impossible to develop any useful applications with the compiler alone. If nothing else, you must buy dBase II to create and modify your database structures.

Improved dBase II

Ashton-Tate's answer to the shock waves caused by dBase III was to declare a policy of continuing enhancement to dBase II. With excellent timing, the people at Culver City released an improved version of dBase II, labelled 2.41, in the same month that dBase III was announced.

At first sight version 2.41 is something

of a non-event since most of the enhancements are fixes of very obscure bugs. The only notable new features were the ability to choose different opening and closing delimiters for Get fields, so you could use > and < signs if you prefer these to the simple colon. There is also a very superior Quit command which allows you to exit to a non-dBase function and then return to dBase at the point where you left it, with all memory variables and parameters intact, although databases are not kept open. This facility is available in MS-DOS and PC-DOS versions only.

First-time users

The real selling point of dBase 2.41 is not its programming features, but the assistance it claims to give to the first-time user. This user-friendly front end does not form part of the official release of dBase 2.41, but was added by Ashton-Tate's European offshoot based at Stony Stratford in Buckinghamshire. Both this and the U.S. version are designated 2.41 and are circulating in the U.K. If you obtained your dBase as part of a software bundle with your computer, you probably have the American version.

When you invoke the European 2.41, you are greeted with the message 'If you are not a programmer, please type Do Menu' and hit Return. The assumption is that you are either familiar with the dBase programming language, or are a newcomer to computing and therefore content to use the pre-written command files called from Menu.Prg. This is silly because most users will fall somewhere between these extremes.

(continued on next page)

dBase II books

Rose Deakin first introduced me to dBase II, back in 1981. As well as being an accomplished writer, Rose is an enthusiastic dBase user, so when I heard that she was writing an introductory book on the subject I expected something worth reading. I was not disappointed. Her *dBase II Explored* is one of the best of the many books on dBase to appear over the last year or so. It is well organised and easy to read. It is one of the few books of its type to emphasise properly the need to plan the application in detail before you get your fingers on the keyboard.

Working with dBase by Mario de Pace is another well-written beginners' text. This and *dBase II Explored* are the only British books on dBase that I have seen, which is a strong point in their favour, as it is refreshing not to have to put up with American terminology and examples.

Of the remaining books about dBase, most provide little more than the material you get for free in the dBase manual. *Understanding dBase II* by Alan Simpson is slightly more adventurous, with some useful sections on interfacing dBase with other software and on producing business graphs from within dBase.

On the other hand, Adam Green's *Advanced dBase II User's Guide* goes far beyond the manuals. It is packed with sample programs, tricks of the trade and esoteric information about the inner workings of the product. As



its name suggests, the book is not for the beginner. It is certainly a big improvement on Mr Green's earlier *dBase II User's Guide*, which was one of the most sloppily written computer books I have ever seen.

Of all the books on this subject, the first is still the best: *Everyman's Database Primer* by Robert Byers. This is not a book on dBase, but rather an introduction to the whole subject of manipulating data within a computer. However, dBase II is used for all the concrete examples, and the book is so well written that it can probably teach a novice more about dBase than the official manual can.

(continued from previous page)

In fact, the Menu system is nothing more than a simple set of command files which carry out common flat-file functions, such as creating and updating a database, printing a report and the like. It is a very useful, if limited tool, and a newcomer to dBase might learn a little about the language by studying the source programs. But apart from this it is difficult to see how it will help the user once he or she needs to go beyond these basic tasks.

A better feature of the European 2.41, also aimed at the novice, is an on-screen tutorial called Welcome. You tell the system what you want to do by selecting an option from a menu, then follow the instructions displayed. You see a dBase command being built up on the screen as you proceed. Finally, the command is executed. It provides an effective, if somewhat tedious, way of learning about dBase, especially for people who hate reading manuals.

dBase II Teach Program

Welcome compares favourably to a similar learning aid called The dBase Teach Program, which comes from the Reston Computer Group. The dBase II Teach Program takes you through the elements of database design, entering and updating data, and producing reports. The information is presented on a series of screens, which you have to plod through in the preordained sequence. Occasionally the program gives you the option of going over the last chunk of material again, but most of the time the computer sets the pace, not the user.

However, the program does a creditable job of simulating an actual dBase session, getting you to type commands at a dot prompt and then displaying the results in true dBase style. But it would be a lot more useful if it went a little further and tried to diagnose your errors, or at least made you try to work out for yourself what to enter. No doubt many people will find it a good way of learning about dBase, but they would probably find Ashton-Tate's Welcome program better still.

Copies of dBase 2.41 originating in the U.S. have neither Welcome nor Menu, but they do have a useful program generator called dGen. Like most programs of its type it can only produce fairly basic single-file applications, but I was very impressed with its ease of use and with the quality of the generated command files. I managed to produce a fairly sophisticated mailing system in 90 minutes without a single glance at the manual. I recommend dGen, which is free with dBase, in preference to Fox & Geller's £200 Quickcode generator.

I also recommend the external sort program, dSort, which is included in both the U.S. and European versions of 2.41. This program is run from the operating system prompt rather than from within dBase and is supposed to sequence a database a good deal faster than dBase's

Suppliers and prices

dBase II version 2.41; distributed by Ashton-Tate, Cofferridge Close, Stony Stratford, Buckinghamshire; available for CP/M-80, CP/M-86, PC-DOS, MS-DOS; £365.

Upgrade from dBase II versions 2.4 to 2.41; distributed by Ashton-Tate; availability as dBase II; £50.

dB/Compiler; distributed by P&P Micros, Todd Hall Road, Rossendale, Lancashire and Micro Minder Consultants Ltd, 36 Replingham Road, London SW18; available for CP/M-80, PC-DOS and MS-DOS; £675.

Expressbase II; distributed by Software Ltd, 251 Goswell Road, London EC1; available for CP/M-80, CP/M-86, PC-DOS and MS-DOS; £125.

The dBase II Teach Program; distributed by Prentice-Hall, 66 Wood Lane End, Hemel Hempstead, Hertfordshire; available for IBM PC and compatibles only; £66.87.

internal Sort or Index commands. My own timings confirm this — see box. Also, like Index, dSort allows you to sort on concatenated fields, while the internal Sort limits you to one field at a time.

One final plus point for 2.41 is the hope that it holds out for the eventual implementation of record locking within dBase II. Long ago, Ashton-Tate stated that it would one day provide this feature, opening up the possibilities of multi-user and multi-tasking applications. Version 2.41 does have Lock and Lockndx functions and an Unlock command. They do not actually do anything, but they are at least accepted by dBase II without syntax errors being reported. So an application developer can insert the necessary hooks for record locking into existing systems for use when these functions eventually become available.

The technical people at Stony Stratford say that they are pushing ahead with multi-user versions of dBase II. The first will be for IBM's Ethernet implementation, with versions for Concurrent CP/M and Turbodos also in the works. However, their colleagues in the marketing department are more cagey, saying that no firm decision has been taken about releasing any of these products.

Meanwhile, third-party add-on programs and dBase II enhancements are still being released at a brisk pace. Since we last reviewed this sector of the market — "Enhancing dBase II", *Practical Computing*, December 1983 — many new products have become available, some genuinely useful, others just gimmicky. Ashton-Tate now circulates details of these independent offerings and of the many off-the-shelf packages written in dBase II.

One third-party add-on which stands out from the crowd is Salamanca Software's Expressbase II, an improved

version of which has just been issued. It is something between a program generator and a macro pre-processor, with a few of the features of a good text editor thrown in. Its main aim is to reduce the amount of coding and typing needed to develop a dBase application, but there is a lot more to it than that.

At its simplest, Expressbase lets you abbreviate common dBase syntax to two-character strings: AF for Append From, SS for Select Secondary, and so on. Some of them generate entire statements. For example, N6 gives

```
@ 23,0 Say "Please Wait — Printing in Progress"
```

Other abbreviations operate on lists of fields specified by the programmer.

The real strength of Expressbase is its use of a library of pre-coded dBase routines, which you can add to and modify yourself. The program line

```
&. DD/MM/YY,Invdate,84,90
```

will pull in a routine that validates the specified variable, Invdate, for proper DD/MM/YY format, checks that it is in the range 1/1/84 to 31/12/90, and produces all the necessary operator messages.

There is also a feature for painting screens, which looks like dBase's Text/Endtext but lets you include Say and Get fields. You can copy chunks of code from one dBase command file to another, altering selected strings on the way. Also there is a global Search and Replace function which operates on a user-supplied list of files. Other features include insertion and removal of indentations, and stripping comments and blank lines from command files.

The program's author, Piers Mahoney, claims a saving of keystrokes of over 50 percent using Expressbase. In favourable cases, I would think that even better savings are possible. Expressbase is a thoroughly useful development tool that should appeal to every serious dBase programmer.

Conclusions

- Ashton-Tate seems determined to carry on supporting and enhancing dBase II. The immediate upgrade to version 2.41 was its first move in this direction.

- New features in dBase II are concentrated on helping the first-time user come to grips with the program.

- Wordtech's dB/Compiler will give a boost to off-the-shelf applications written in dBase II. It provides faster running times, protection of source code and lower distribution costs. But the fact that it is copy-protected in its 16-bit versions will hamper its acceptance by software houses and large users.

- The market continues to be assaulted by dBase add-ons from independent suppliers. One of the best is Expressbase II, which can do wonders for a dBase programmer's productivity. 

Let Fujitsu give you all the info on the Micro 16s at INFO '85, Level One, Stand 161/168

If you can't visit us at Olympia 2 then telephone
Maidenhead (0628) 76100 today for your personal
presentation pack on the FUJITSU MICRO 16s

How to find us at Olympia 2



How to find us at INFO '85

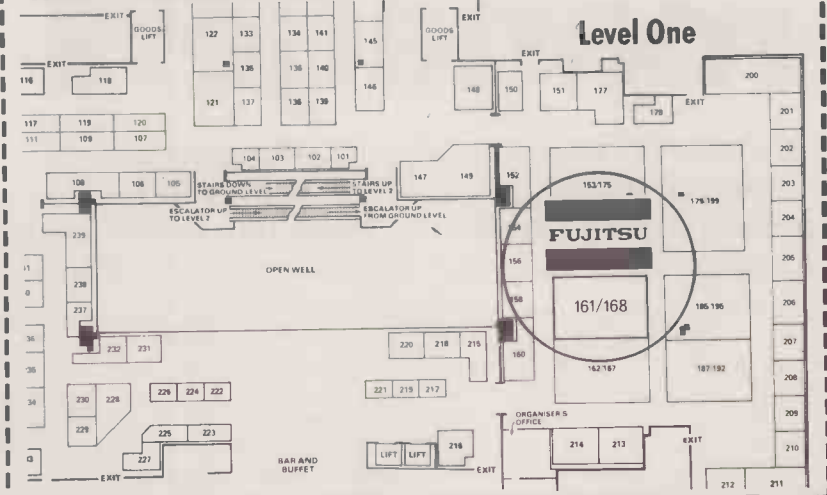

FUJITSU
MICRO 16s

FUJITSU

**FUJITSU Mikroelektronik
MICRO COMPUTER SYSTEMS**

Hargrave House Belmont Road
Maidenhead Berks SL6 6NE
Tel: 0628 76100 Telex: 848955

● Circle No. 117

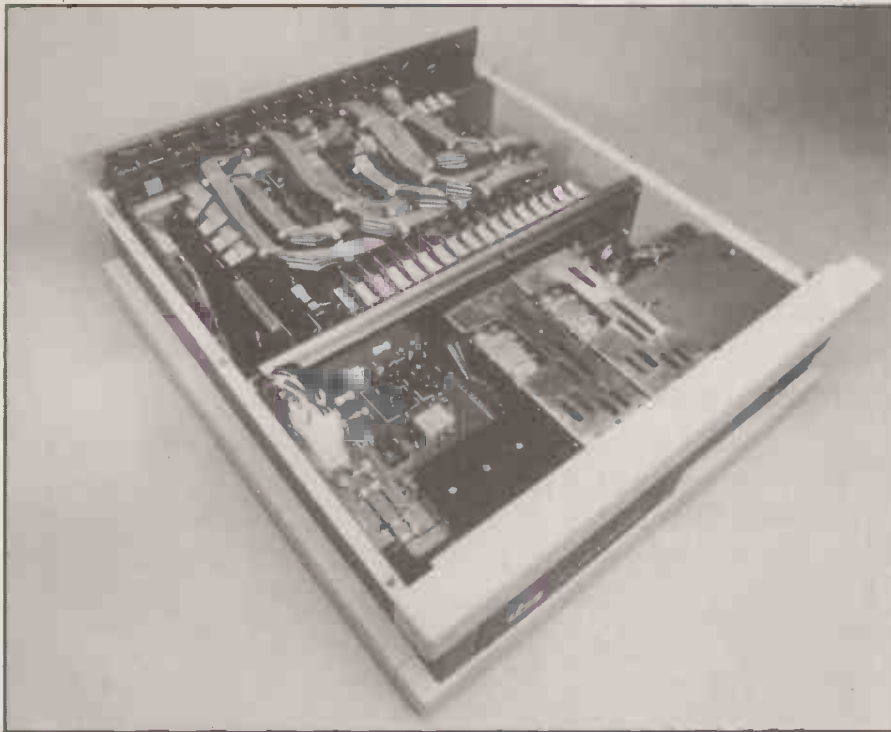

A good way to build a multi-user system is to use an S-100 bus design and provide each user with their own processor card. Here an IBS Ultraframe is shown equipped with 16 such cards, which means that each user does not degrade the system's performance for the others. A similar system is used in other 16-bit British micros such as the HMS Minstrel and Bromcom Superstar.

As far as the operating system goes, the candidates in common use are Xenix, Unix, Idris — Whitesmith's proprietary Unix — and Multi-User Concurrent CP/M. The operating system has to do a number of tricky jobs. This and the hardware requirements almost guarantee that if it is to work at all a multi-tasking system has to be well designed, but it also tends to make it expensive and over-specified for the user who wants to start small and build up to bigger things.

Users share programs

Under a good multi-tasking operating system, it is also possible to make several users share the same programs. The data areas of each user's programs are kept separately, but they share the same machine-code instructions. This gives some economy in memory at a cost in development time and complexity.

The second possibility for implementing multi-user operation has been seen more in eight-bit machines than 16-bit ones. In it each user is given their own processor, which is linked to the central file server by some fast cable. If the processors are physically in the same box they can share a data bus; if they are physically separate they communicate with the file server by more or less sophisticated and expensive wire.

In many ways this was a good solution. The processors were cheap and as more users were added they did not degrade each other's processing power. Moreover, it was usually quite easy to grow the system as the number of users increased.

Multi-user database managers

As databases get larger, and the programs to manage them more sophisticated, multi-user operation becomes almost essential. Peter Laurie examines the problems of putting it into effect.

FOR A WHILE one wondered why God, in his infinite wisdom, had sent us the 16-bit micro. It didn't do word processing or spreadsheet calculations any better than the eight-bit machines. In fact, it often did them more slowly. It had been developed more hastily than the eight-bit machines, by less expert people under more savage commercial pressures. All this showed. It started life as a flawed beast.

However, the divine plan is now beginning to emerge. The obvious use for a big-disc, multi-user 16-bit micro is to hold large amounts of information which are shared around between a small group of, say, six to 12 co-workers. The 16-bit micro is to become multi-user, get socking great discs tacked on and run huge database management packages. As publishers of one of the very few multi-user database-management packages around, my

colleagues and I at Southdata naturally approve of this celestial scheme.

All the serious computer shows in the past six months have been infested with multi-user hardware. Multi-user software has been less in evidence. It is interesting to ask why this should be so.

Multi-user operation manifests itself at a number of levels and in a number of forms. It is important to get clear in one's mind the different ways in which it is achieved in hardware before you can talk sensibly about the software. There are three main ways of doing the trick.

The first is multi-tasking, in which a computer is switched between users in such a way that each user thinks that he or she has a computer of his or her own. There obviously has to be a powerful processor and a proper multi-tasking operating system.



The idea seemed to go out of fashion along with eight-bit micros, though suitable 16-bit machines are now becoming available.

In the final method, using a local area network, each user has a stand-alone micro; they may, in the most horrific case, be by different manufacturers. All the machines are connected physically by a network, and logically by more or less sophisticated software. In the simplest case, the dependent machines can read the discs of one other, designated the file server. In more sophisticated examples they can send messages to each other, read each other's discs and, in extreme cases, use each other's RAM. I do not wish to seem cynical, but few examples of this sort of thing working in practice come to one's attention.

Although the different schemes present very different problems to the machine builder and the system software programmer, they all work surprisingly alike at the level of the database manager. The main thing to remember about a multi-user database is that all the data, both in and out, flows through the disc's read-write heads. Processing is relatively unimportant: however powerful and sophisticated the micros, disc access is the limiting constraint.

Some problems

From the point of view of database management there are a couple of problems which arise in multi-user computer systems. The first is known as record contention. When user A alters a record, it must be locked by the database manager so that user B cannot alter it at the same time. This sounds quite easy to do but in practice most database managers are written so that the fields of each record generate parallel files in some sort of way, which are buffered up to reassemble the record.

No doubt this architecture had its origins in the early tape-storage devices,

when each field had a tape or a track to itself. Although the hardware has changed, the philosophy has stayed the same. The buffers cannot accurately reflect the current state of the disc, so to lock a record you effectively have to lock all the fields. In a database with several hundred fields per record this means writing to several hundred files — or several hundred places in a single database file — to do the lock. This is not very practical and seems to be why there are so few multi-user database managers.

Blissful ignorance

Happily for us, when we started to write our multi-user database we knew nothing about database design and did not use the traditional architecture. A record to us is a text string with markers separating the fields. It is easy to lock such a record by altering one bit in a header byte. The clever stuff that makes the database do its thing all happens in the indexes, which are separate.

A problem specific to local area networks is that of disc buffering. Networked machines usually run single-user operating systems such as CP/M-86 or MS-DOS, with a bit of code tacked on to handle communications on the network. The single-user operating systems seem to speed up disc access by copying a chunk of disc into a buffer every time it is read.

The argument is that the user will probably want to access a neighbouring portion of the disc next time, and will be agreeably surprised to find that it is already in RAM. Conversely, when the user's program writes to the disc it actually writes to a buffer in memory and from time to time that buffer is flushed on to the disc — thus, again, producing an apparent increase in disc speed.

This is no good at all when the machines are accessing a multi-user database because each machine keeps an image of the database in its buffers and quite certainly the images will not agree with

The HMS Minstrel 2 is, in effect, a multi-user network in a box. Each user has their own processor, which can be eight-bit or 16-bit, and all are joined to the hard disc by the S-100 bus.

reality. To make single-user machines work multi-user in a network, the operating system's buffering has to be disabled, which naturally makes the machines work less quickly.

Another problem is that single-user operating systems are not written to cope with the rigours of multi-user life. Programs are much more likely to run amuck, and there are no impermeable barriers between them and the crucial disc-status information held in RAM. This can get corrupted, with horrible results to the communal database next time that machine writes to the file server.

Even Multi-User Concurrent CP/M does not handle this properly: the file-control blocks are exposed within RAM, waiting for a morsel of errant code to wreck them. The next time someone writes to the disc you end up with a smashed database. The answer is to use a properly written multi-user operating system like Unix which raises an impenetrable barrier between applications programs and the operating system.

A more academic problem is the so-called deadly embrace. This arises in a relational database when the user wants to alter a virtual record made up of records type 1 and 2. User A gets a lock on record 1, while user B gets a lock on the type-2 record. They both then try for the other and fail, and so on indefinitely. There are a number of solutions: you might, for instance give priority to the user calling for a lock whose first locked record is nearer the head of the file.

Nothing is free

On the other side of the CRT screen there are more troubles. The salient fact about a big database is that it is big. Making one and living with it imposes its own set of problems. The first is that nothing is free, even the all too evanescent database record. It can hardly cost less than 50p to acquire, type in and verify each record in a real-life database.

People agree to this proposition and then airily talk about 70,000-record databases — for instance, an MP's constituents and how he or she has changed their lives in a way that can be vote-catchingly drawn to their attention at election time. When you point out that such a database can hardly cost less than £25,000 — considerably more than the hardware and software needed to run it — the hopeful customer is dismayed.

And then, unless you are cataloguing the major fixed stars, the data is going to slither about. People move in, move out, are born and die. Customers appear and disappear and change their spots. Even the fixed stars move slowly about the sky. Any big database needs to have its data massaged and polished.

It is sensible to think of having to work on at least 10 percent of the records per year, which can be a full-time job and

(continued on next page)



(continued from previous page)

another substantial cost. And, of course, if someone is working full-time maintaining the database, it has to be running on a multi-user machine so that users can get some virtue out of the thing at the same time.

A further problem people stumble over in moving from paper to electronic systems is that computers are far more nervous than paper. An electronic database with the years of work it contains can disappear utterly in the twinkling of an eye. It needs far stricter backup discipline than a paper system, which hardly needs any.

How many times have I had tearful phone calls saying "It seemed to be working so well we didn't bother about the backups. . . ." Data entry, too, needs to be much more tightly controlled. Most of a database is out of sight and it is certainly out of mind. Because no one has to look at entries to perform most functions, mistakes in the data can propagate like weeds and produce hideous blunders.

Act is unclear

A further hassle will soon be introduced by the Data Protection Act. This is a badly drafted statute which seems to assume that characters written on a disc have magical qualities not possessed by the same characters on paper. It is far from clear who is allowed to do what under the Act and what will happen to them if they do or don't do it. This is not the place to try to analyse it, but the effect on many people will be to force them to be seen to be keeping their databases in some sort of security.

This means that the software has to provide password protection, probably down to field level. It will impose all sorts of aggravating restrictions on access to hardware and software. Once the system is up and running, a printout of the databases registered under the Act —

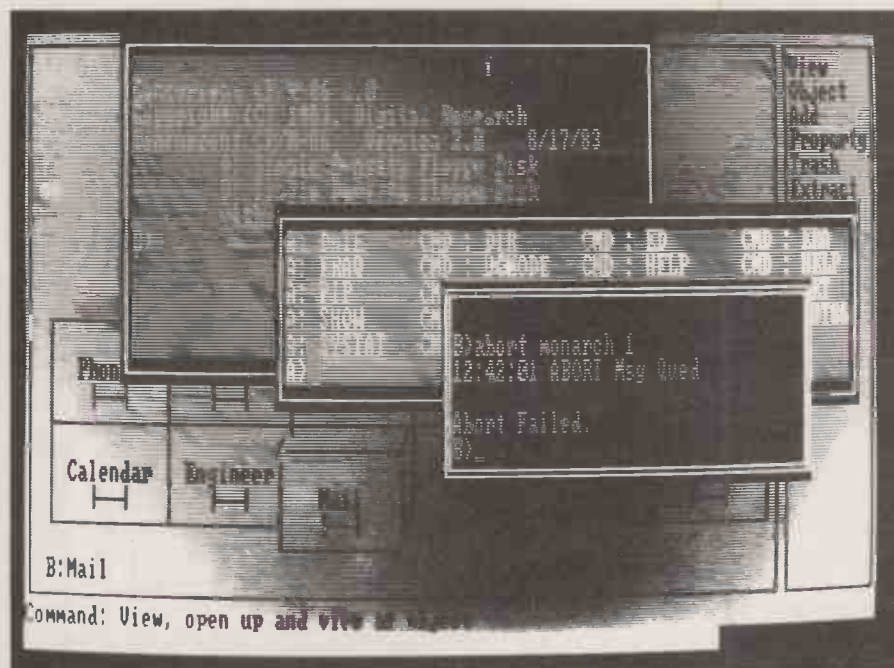

Screen display using Concurrent CP/M with windows. One user can run several programs at once and switch between them at will.

which has to be given to anyone who asks — will, I estimate, weigh something like a ton and take several months to read through.

This is not to say that big databases on 16-bit micros are all bad. They just have downsides to their upsides, as do most things in this troubled world. What they do give is instant access to quite large amounts of data, searching if necessary on hints, clues and whispers. They provide small groups of people with almost instant communication. The costs of storage are dropping, but are still way above paper archives, so designers of big micro databases have to make a sensible trade-off between completeness and paring the data

down to what is actually worth keeping on-line.

If and when the new laser discs come into general use our philosophy about database management will have to change again. The problem is that to be useful data in a database has to be indexed. This imposes a lot of disc writing, which will take a long time on laser discs. To make the thing useful, a vast database which is slow to access — and mercifully hard to destroy — will live on the laser disc. A smaller auxiliary database will live on big hard discs to facilitate access and to provide a temporary store for new and altered records.

AI and databases

In the more immediate future it seems that people want database managers to broaden out to accept text data as well as the conventional short database fields, and also to accept pictures as special database fields. Developments are happening in other directions too. Southdata has already released an artificial-intelligence package the function of which is to run about a Superfile database and try to discover rules hidden in it. The first serious applications seem to be to investigate creditworthiness criteria among the payment records of customers of banks and big public utilities.

Whatever happens, it seems sure that the stimuli of powerful 16-bit hardware and a rapidly increasing market for data-handling software will give the art of database management a great deal of encouragement and evolve many hitherto unsuspected software products. 

Peter Laurie is managing director of Southdata Ltd, publisher of the Superfile multi-user database.

Multi-user systems suppliers

	CPU	Major OS	Comments	Phone
Alpha Micro 1000	68000	Amos	Up to seven users	(0753) 821922
Altos 8600	8086	Unix		(0990) 23377
Armstrong Multi-Micro	68000	Unix	Also for science/education etc	(0384) 233433
Bleasdale 68000	68000	Unix		01-828 6661
Bromcom Superstar	80186	IMPOS	Multi-processor system	01-697 8933
Cifer 9000	68000	Unix and CP/M Plus	Four to eight users	(0225) 706361
Country C-4000	80186	Concurrent CP/M	Up to four users	(0527) 29826
Crystal 68000	68000	Unix, Plick	Up to 12 users	021-359 4861
Equinox 8000-S	80186/Z-80	Turbodos	Multi-processor system	01-729 4460
HMS Minstrel	various	Turbodos	Multi-processor system	01-209 0911
IBS Magnum	80186	Turobdos	Multi-processor system	01-222 4701
IMP-68	68000	Unix or Idris	Also six optional Z-80 slaves	(0207) 503481
Jarogate MP-5	80286	Concurrent CP/M	Up to 16 users	01-671 6321
Newtons Accron	68000	Concurrent CP/M	Multi-processor system	01-874 6511
Positron 9000	6809	OS-9		(09252) 29741
Rair BC II	8086/Z-80	Concurrent CP/M	Up to four users	01-836 6921
Systime S-300	8086	MPS, BOS	Up to five users	(0532) 702277
TDI Pinnacle	68000	p-system	Up to seven users	(0272) 742796
Torch Unicorn	68000/Z-80B	Unix, p-system	Can network BBC Micros	(0223) 841000

How much persuasion do you need to buy a world beating business computer?

New 80286 Super Micro with Massive Memory and Networking as Standard

Incorporating Intel's new IAPX 286 high performance chip, up to 6 Megabytes of main memory, 256K of disk cache buffering, multi-user and Ethernet networking facilities as standard - Sprite is a fully developed business machine packed with state of the art technology.

CCP/M86 and IBM PC AT Compatible

Sprite was designed specifically to support concurrent and multi-user processing. The next generation of increasingly sophisticated, faster, more productive software packages will demand more computer memory and processing power. Sprite will run these new programmes effortlessly, under concurrent CP/M86 with PC mode or Xenix for IBM PC AT compatibility.

Technical Specification

- 6MHZ 80286 Main Processor
- 2 to 18 users
- 512K to 6Mb main memory (no wait state)
- 21 to 140 Mb 5 1/4" Winchester disk
- 790K Floppy (IBM PC compatible)
- 256K byte intelligent cache buffer
- 80287 Arithmetic co-processor option
- Ethernet controller as standard with 'Cheapernet'
- IBM PC compatible colour graphics option
- 4 RS232 ports with synchronous & modem support
- 3 parallel ports, centronics compatible
- Intelligent 8 port RS232 expansion option
- S100 and IBM PC bus compatible
- Digital research multi-user CCP/M86 with PC mode, windows, GSX and DR-NET
- Microsoft Xenix (for IBM PC/AT compatibility)

1 Year's Free Maintenance

In the unlikely event of your Sprite breaking down, our free maintenance contract guarantees an engineer at your site within 24 hours.

Based on Proven Technology

Sprite has been developed by Jarogate, a leading force in the specialist computer market. Clients include: Marconi, Duracell, Vauxhall and other leading names. Companies not easily persuaded.

Excellence at an Ordinary Price

Starting at £4,995 Sprite costs no more than its rather ordinary rivals, it's just technically far superior. We're confident that a demonstration will provide all the persuasion you need to make the right decision. Compare Sprite's performance, price and support package with anything else. Then decide. For further details return the coupon now, or telephone: 01 671 6321.



I'd like to know more about Sprite: (tick as appropriate)

Please arrange a demonstration Please send me more information

Please send me your dealer pack

Name _____ Title: _____

Company _____

Address _____

Tel: _____ PC4/85

Return to Jarogate Ltd., 197-213 Lyham Road, Brixton, London SW2 5PY.
Tel: 01 671 6321 Telex: 8950094



Computing ahead of its time

All software products described are covered by trademarks of the companies of origin.



Progress by stealth

Glyn Moody visited a City broker, where he discovered the use of micros slowly spreading after a cautious start doing routine accounts.

NEW YORK based Drexel Burnham Lambert is America's 10th-largest brokerage company, with equity capital of over \$320 million. The firm has a London arm as a base for European operations. As well as handling securities and commodities trading on local exchanges, the London office is responsible for expense control and reporting.

The commodities section in London employs about 250 people, most of whom work on the desks that handle different groups of commodities. For example, the tropicals desk deals with transactions in cocoa and coffee, the grains desk in potatoes and soya beans, and the energy desk in oil and gas.

In an environment that places such a high premium on communications and availability of information, computers have had surprisingly little impact. A mainframe in New York is used to process transaction trading and there are a number of dumb terminals displaying on-line services from information providers such

as Reuters. Otherwise, micros are conspicuous by their absence.

However, one small corner of the large and bustling fifth-floor office is gradually being colonised. A year ago the accounts department depended on a lone 256K IBM PC with monochrome screen. Now it has progressed to an additional three 640K machines with full-colour graphics, and a hard-disc unit with tape streamer backup. An IBM PC/AT is on order.

1983 changeover

The road to computerisation began back in 1983, when there was a move towards profit-centre accounting. Costs were to be allocated to each of the 14 individual commodities desks. The man who bore the brunt of the changeover was Jim Reardon, the systems accountant. As he says, "We started off manually, but it just became too much."

First, there was an Apple III, which arrived in a typically ad hoc fashion. "It was purchased originally for some of the

Micros are conspicuous by their absence on the main commodities floor.

management secretaries to use for word processing. They couldn't or wouldn't use it. So it got swabbed off on to the accounting department. They said 'here's a computer, see if you would like to use it'."

After this inauspicious start, Reardon began investigating what could be done on the Apple using VisiCalc. "I started playing with it, learning what we could do. Until all of a sudden we started doing more than VisiCalc was capable of." An accounting package was needed that would meet the company's special needs.

When nothing was found for the Apple III, the company started looking further afield. Again, the acquisition pattern was slightly arbitrary. The financial controller, Chris Lang, read about the Sunaccounts package, in a magazine, and according to Reardon "just followed it up from there." Similarly, the IBM was chosen because it seemed to be the machine to use with the package. Although they took no independent consultants' advice, Lang and Reardon were careful to put the system through it paces.

After the system was purchased, the supplier, Merchant Systems, gave a morning training session on the accounts package and how to use the demonstration ledger. This proved sufficient to get Reardon into the system. "It was just a matter of sitting down and using the demo ledger. I worked through that and then took it from there."

In implementing the changeover from a manual system to a computerised one Reardon was helped by previous experiences. "We were pretty careful when we



The accounts department uses the IBM PCs for spreadsheet calculations.

implemented it, probably because two or three years ago I was involved with the implementation of a new accounting system. I'd learnt a little about the pitfalls and the need to take it slowly."

In particular, Reardon emphasises the importance of parallel runs using a full month's data. "Given the experience of what can happen without lengthy parallel runs, I wanted to give ourselves a good chance by having a good parallel run. I knew that we had to test it completely on the month-end reports rather than taking some invoices and running them through and seeing if the system worked with them." The system was set up in January last year, with parallel runs in January and February. It went live in March.

No shock horror

Compared to some of the horror stories that such changeovers generate, things went very smoothly. Once the system was being used full-time, one or two shortcomings emerged that had passed unnoticed at the time of evaluation. "There were a couple of things we thought it would do at the time of buying it, which it still is unable to do," says Reardon. For instance, it turned out that there were more cost centres than the system could handle. A possible solution was to have some new code patched in by the author of the package, Systems Union. But as Reardon says. "We approached Systems Union about writing that in and they gave us a figure of £1,500. So we said forget it."

One thing the company is having written is a batch-file facility, similar to the batch

option available under MS-DOS "so that you can run a whole lot of reports one after another. At the moment Sunaccounts lets you run one report, then you go back to the main menu."

In fact this proved to be the main problem with the new system. "One of the big shocks for us once we got the system up and running with data was how long it took to run some of these reports. We've adjusted to it now, but we didn't realise just how long it was going to take our month-end reports. They're usually about four to five hours each in running. It's basically an overnight job, that's why we needed the batch files."

In general, the response time of the system varied according to the particular use. "Posting journals isn't too bad, but with enquiries into accounts that have a lot of data in them, like the telephone account for instance, there's a two- to three-minute delay in getting the information up on to the screen. It's a bit slow."

Speed is quite a common problem with new systems but at least is predictable in terms of its effects. Another difficulty encountered by Reardon was more capricious. "I'm not sure whether it's the machine or the building or a combination of the two, but they seem very susceptible to static. We had a lot of systems failures due to static. We've got static mats down, but it doesn't seem to help a lot."

This is something they have learnt to live with. It has at least had the advantage of encouraging full and frequent backups to be made. Larger maintenance problems are covered by a maintenance contract with Merchant Systems, which Reardon considers indispensable.

Once the Sunaccounts system was

working smoothly, people's thoughts turned to other applications. "We read a little about Lotus 1-2-3 and figured that for the price it was probably worth it. We were doing a lot of spreadsheet work on the Apple III with VisiCalc."

The additional facilities of 1-2-3 have proved of real worth. "We use the graph function, we use the data sorting. We're using Lotus just about as much as it can be used. In fact we've got Symphony now." The extra features of Symphony have also been useful. "Symphony is more user-symphathetic," says Reardon. The graphics facilities of both packages are used to enhance management reports.

Partly as a result of the activity in the accounts department, it was decided to begin computerising the personnel section. Reardon had been using Silicon Office for another project but it proved too slow. "But for the personnel function we found it ideal. It's working really well." It took Reardon about a month to set the system up. He found it quite straightforward even though his programming skills were still quite slender: "Silicon Office is a kind of idiots' Basic."

According to Reardon, it is still too early to judge the cost-effectiveness of the personnel system. However, he says "Probably the personnel department would have needed to take on an extra employee this year, whereas now they won't. So probably it will have paid for itself inside the first year."

Definite success

As far as the main system is concerned, Reardon is more definite. "We just couldn't have handled manually the amount of work we're handling now. We've basically got the same staff that we had when we were producing entity accounts and nothing else, which involved maybe 10 foolscap pages a month going to New York. We now produce something like 100 pages of management reports every month. The figures that we're producing now are actually quite meaningful. The figures that we were producing two years ago were accurate, but as a management aid were not really a lot of use."

With such a marked improvement on the past, what does the future hold? Once the IBM PC/AT on order arrives, Reardon thinks that the company will be "looking at networking very seriously. We're waiting to see what PC-DOS 3.1 provides in terms of networking."

Beyond that, there is a longer-term plan for the London accounts department to take over the expense reporting for all the international commodities offices, effectively bypassing the New York branch. The final expense accounts would be sent direct to the mainframe using the PCs as terminals. "New York are obviously trying to hold on to as much as they can, but basically we in London have proved we're completely capable of handling the cost-accounting side of the operation." 

ARE YOU ASKING TOO MUCH OF YOUR CURRENT SOFTWARE?

Come along to Software 85 and discover how to make your software stretch much further.

Professional users will find a host of new software applications to make your business computing more versatile and more efficient. Just about every innovation on the market today will be at the show.

What's more you'll be able to see all the software you're interested in actually running on the stands, and its applications being explained by informative salesmen.

To underline the importance of Software 85, we're also staging a conference where you'll hear industry experts discussing the latest software developments, and what potential they hold for your business.

Don't miss this unique chance to see all the latest in business and professional software.

Entrance to Software 85 is FREE by business registration only, so make sure you send for your tickets today.

If you're serious about software don't miss Britain's only dedicated software event.

**Earls Court,
London.**

**June 4-6, 1985.
Open 10am-6pm.**

**Software 85
will run alongside
The Business
Computer Show.**

Sponsored by:
**Computer
Weekly
and
NCC**

software 85 EXHIBITION & CONFERENCE

Return to: Software 85,
Reed Exhibitions, Surrey House, 1 Throwley Way, Sutton, Surrey SM1 4QQ

Please send FREE tickets for Software 85
Please send me further information on the Software 85 Conference
Name _____
Company _____
Address _____

Battery portables grow up

Computing power you can carry around — our top 10 selection, introduced by Ian Stobie.

BATTERY-POWERED portable computers are finding a new and more ambitious range of applications as they become more powerful. The earlier generation of portable machines were used mostly to collect data, doing relatively little with it before passing it on to a larger system or to the human user. All the machines surveyed here can do much more, often equalling the office-bound desk-top machines in their ability to process data themselves.

But portable machines are suited to more than just giving greater geographical freedom to familiar tasks like word processing and spreadsheet analysis. Using software developed by the GLC, home-help supervisors in London are now taking Husky portables along with them on visits to elderly housebound people; they are using the system to check if the client is receiving the correct level of welfare benefit.

The army has been experimenting with the same machine to work out the optimum siting of radio trucks in the field, working out the signal-strength loss from a map of the terrain contained in the machine. Wycliffe Bible Translators has been taking Sharp PC-5000 into remote parts of the world to analyse and document little-known local languages.

What all these applications have in common is the need to store large amounts of data in the portable machine, as well as a program to help the machine's operator make proper use of it. These are so-called knowledge-based or expert systems: the portable has a great advantage because it can be taken to where the knowledge or expertise is required.

To be genuinely portable a computer has to be battery-powered, and for this survey we mean genuinely battery-powered — any machine that cannot survive a typical seven-hour working day without a recharge is excluded.

All the machines here have proper full-size keyboards suitable for touch-typing, except the two machines designed for ultra-rough treatment. Since the Fieldwork Fifty and the Husky Hunter are both powerful systems capable of running CP/M programs like dBase II it is absurd to lump them in with slow, calculator-like pocket computers. The Husky and Fieldwork Fifty sacrifice the standard keyboard design in order to enhance their ability to go almost anywhere.



Suppliers

DG One: Data General, Hounslow House, 724-734 London Road, Hounslow, Middlesex TW3 1PD. Telephone: 01-572 7455

Epson PX-8: Epson U.K. Ltd, Dorland House, 388 High Road, Wembley, Middlesex HA9 5UH. Telephone: 01-902 8892

IBS Fieldwork Fifty: Immediate Business Systems plc, 3 Clarendon Drive, Wymbush, Milton Keynes MK8 8DA. Telephone: (0908) 568192

HP-110: Hewlett-Packard Ltd, PC Group, King Street Lane, Winnersh, Wokingham, Berkshire RG11 5AR. Telephone: (0734) 784774

Husky Hunter: Husky Computers Ltd, PO Box 135, 345 Foleshill Road, Coventry CV6 5RW. Telephone: (0203) 668181

Olivetti M-10: British Olivetti Ltd, PO Box 89, 86-88 Upper Richmond Road, London SW15 2UR. Telephone: 01-785 6666

NEC PC-8201a: NEC Business Systems (Europe) Ltd, 35 Oval Road, London NW1 7EA. Telephone: 01-267 7000

Sharp PC-5000: Sharp Electronics (U.K.) Ltd, Sharp House, Thorp Road, Manchester M10 9BE. Telephone: 061-205 2333

Tandy models 100 & 200: Tandy Corporation, Tameway Tower, Bridge Street, Walsall, West Midlands WS1 1LA. Telephone: (0922) 648181

TI Prolite: Texas Instruments, Manton Lane, Bedford MK41 7PA. Telephone: (0234) 67466

Small, inexpensive calculator-like machines are produced by firms like Casio and Sharp, and now have good Basic interpreters and reasonable amounts of RAM. But these machines are clearly aimed at a different section of the portables market to the full-blown computers we restrict ourselves to here.

Obviously you pay a price for the ability to move independently of the power supply — portable computers are often slower or have less available storage than a mains-driven machine. But this price is declining very rapidly as portable technology improves. In this survey we have two portable 16-bit IBM compatibles — the DG One and the TI Prolite — and three portable eight-bit CP/M machines which are in many respects as good as anything you may find on an office desk.

The major improvement since our portables survey last year has been in storage. The most powerful machines now have 3.5in. Sony disc drives, and most of the others have substantial amounts of battery-backed RAM, which is no longer prohibitively expensive. Bubble memory is still favoured by a few manufacturers, chiefly those whose machines are intended for rugged outdoor use.

The one remaining area of real limitations is the display. Portable machines obviously cannot use the heavy and power-hungry cathode-ray tube, and none of the alternatives are as good. But things are changing and LCD panels are becoming larger and easier to read.

The modern battery portable has already acquired the ability to run much more than the small calculating programs, data-capture programs and limited text editing which were typical to pioneering machines like the Sharp PC-1500 and the Epson HX-20. Word processing with a full-scale word processor like WordStar, spreadsheet analysis with Multiplan, database management and report generating with dBase II are more characteristic applications for the latest machines.

Since these machines are portable, and mostly have adequate storage, they are also ideal for knowledge-based systems in the widest sense. This is the area where portables are likely to prove pre-eminent in the future. Jack Schofield takes a look at the more traditional area of word processing on portables on page 110 of this issue.



DG ONE

£2,490

Extremely powerful battery-powered portable computer offering genuine IBM PC compatibility, but at a price. Weighing 9.5lb., Data General's One has a very large LCD panel measuring 10in. diagonally, which can show 80 by 25 lines of text or 640- by 256-dot graphics. The QWERTY keyboard layout feels slightly cramped but Data General claims it to be full size. Inside the One has a CMOS 80C88 processor, 128K of RAM expandable to 512K, and 64K of ROM containing text editor and comms software. A Sony 3.5in. 720K drive is built into the side of the machine, with a second optionally available. MS-DOS is included in the price. Lotus 1-2-3, WordStar and dBase II are available on disc.

For. IBM compatibility. Large memory. Built-in disc.

Against. High price. Poor display contrast on earlier examples.



EPSON PX-8

£798

Powerful A4-sized portable, with CP/M and WordStar included in the price. Weighing just under 4lb., the PX-8 has a fold-away LCD which shows eight lines of text across a full 80 columns or 64- by 480-dot graphics. Inside is a CMOS Z-80 look-alike processor running at 2.5MHz, and 64K of RAM. CP/M 2.2 comes built-in, together with WordStar, Microsoft Basic, Cardbox Plus and Micropro's Calc program on plug-in ROMs. A built-in microcassette drive offers 32K per side storage. A £200 clip-on expansion unit adds 128K of RAM, treated by CP/M as a silicon disc. Other options include a battery-powered 3.5in. microfloppy disc, printer and acoustic coupler. A similar machine with a 40-column display is available from several OEMs.

For. CP/M and WordStar. Big display. Optional silicon disc.

Against. Display is hard to read in poor light.



FIELDWORK FIFTY

£1,760

Tough, light portable that runs CP/M software and uses bubble memory instead of discs. Intended for use in harsh environments, it is waterproof and floats. Weighing 3lb., the machine has a two-line by 40-character LCD with backlight for night-time use. The keyboard is slightly less than full size, and available in various layouts. The processor is a CMOS variant of the eight-bit Z-80, and the machine comes with 56K of RAM. The standard 64K of bubble memory is expandable to 256K. It comes with Microsoft Basic and a CP/M-compatible operating system, which makes it possible to run CP/M 2.2 programs such as dBase II. A full RS-232C is fitted, and several micro to mainframe comms packages are available, as well as a bar-code reader.

For. Very tough. Runs CP/M software.

Against. High price. Small display.



HP PORTABLE PC

£2,995

Powerful battery-powered portable with very good bundled software. The Portable PC has already gone under several different names in its short career: HP-110, Gypsy and Nomad. It weighs 6.5lb. and has a full-size keyboard. A fold-down LCD shows 16 lines of 80 characters or 126- by 460-dot graphics. Inside is an Intel 8086 processor and 272K of RAM, some of it configured as a silicon disc. The Portable PC comes with a massive 385K of ROM, containing MS-DOS, Lotus 1-2-3, HP's Memomaker word processor and comms software, as well as a similar user-friendly front end to that offered on HP's 150 desk-top machine. Options include a battery-powered 3.5in. Sony disc unit and acoustic coupling modem, which connect to the 110's HP-IL and RS-232 ports.

For. Lotus 1-2-3 in price. Good range of add-ons.

Against. Keyboard not perfect.



HUSKY HUNTER

£997

The extremely robust Husky Hunter is still the smallest machine running CP/M software. It has a cast aluminium case measuring 8.5in. by 6in., and weighs 2.5lb. The Hunter is built to stand up to harsh conditions, and the QWERTY-layout keyboard is not full size, but it is sealed and waterproof. The eight-line by 40-character LCD can also show 64- by 240-dot graphics. Standard RAM is 80K, expandable to 352K, some of it configurable as a silicon disc. A CP/M 2.2-compatible OS, Microsoft Basic, text editor and comms software to drive the RS-232 port are supplied in ROM. The Hunter's CMOS processor can run CP/M software as fast as a typical eight-bit desk-top system. Options include modems and a mains-powered disc drive.

For. Fast. Very tough. Large CP/M software base.

Against. Small keyboard.

Battery portables: top 10



NEC PC-8201a £299

The PC-8201a is built by the Japanese firm Kyocera, which makes very similar machines for Olivetti and Tandy. All three versions pack an eight-line by 40-character LCD and a full-size keyboard into an A4-sized package weighing under 4lb., and are built around the same eight-bit CMOS processor, the 80C85. A cassette interface lets you store programs and data on a domestic tape recorder. The NEC version starts with 16K of RAM, expandable to 96K. The optional RAM expansion cards are battery-backed and can be exchanged with their contents intact. The NEC's 32K ROM contains Microsoft-written text-editing program and a full Basic. There is a full RS-232 interface. Used with any suitable modem, the NEC is ideal for Telecom Gold.

For. Price. Good memory expansion. Good Basic. Nice keyboard.

Against. Few dealers.



OLIVETTI M-10 £399

Like the NEC and Tandy portable machines, the M-10 is built by Kyocera around the same eight-bit 80C85 processor but this time the base model comes with 8K of RAM, expandable to 32K. Physically the machine is very similar: A4-size, weighing under 4lb., with good-quality full-size keyboard and eight-line by 40-character LCD. The Olivetti's display pops up for better viewing and probably is the most readable of the three. The 32K ROM contains Microsoft's text editor, Basic, and simple address list and appointments programs. The Basic is good but slightly inferior to the NEC version. Olivetti is giving away a free mailbox on the Telecom Gold electronic mail service, a matching battery-powered acoustic coupler costs £250. Multiplan is available on plug-in ROM for £95.

For. Clear display. Olivetti name. Good support for Telecom Gold and comms.

Against. Less memory expansion potential than NEC. Pricey.



SHARP PC-5000 £1,195

Competitively priced battery-powered portable with MS-DOS and optional bubble memory. The Sharp PC-5000 comes with eight-line by 80-character LCD also capable of showing 80-by 640-dot graphics, and a full-size QWERTY keyboard. Inside is an Intel 8088 processor, 128K of RAM expandable to 256K, and 64K of ROM containing MS-DOS 2 and GWBasic. A plug-in 128K bubble-memory module adds £169 to the price, and is really necessary to do much with the machine. An optional battery-powered A4 printer, price £275, clips on to the PC-5000 to form a single neat portable unit. An external twin floppy-disc unit is available for £675. Some packages, including Supercalc, WordStar and Superwriter, are available on bubble cartridge or ROM.

For. Keen price. MS-DOS. Bubble option. Clip-on portable printer.

Against. LCD panel hard to read. Bubble software expensive.



TANDY 100/200 under £1,000

Tandy look like being first off the mark with the new Kyocera machine, the Tandy 200. This has a 16-line by 40-character LCD, 24K of RAM expandable to 72K and 72K of software in ROM, which includes Multiplan as well as an improved version of the text editor found on the Tandy 100. Like the earlier machine the Tandy 200 is built around the 80C85 chip, so there is no immediate prospect of CP/M compatibility. Tandy hopes to have British Telecom approval for a built-in modem when the 200 goes on sale in the U.K. around June. Tandy continues to sell the cheaper Tandy 100, which has an eight-line display and 8K of RAM expandable to 32K; it costs £303 and is basically the same machine as the NEC and Olivetti portables surveyed here.

For. Tandy 200 has large display, good memory expansion and Multiplan.

Against. Tandy 200 is not yet here, and looks pricey. Tandy 100 has limited memory expansion.



TI PRO-LITE £2,995

Expensive 16-bit IBM-compatible portable similar to Data General's One, but offering even more facilities. The Pro-Lite is heavier at 10.5lb. and has a larger 12in. LCD showing 80 by 25 lines of text or 640-by 200-dot graphics. Inside is the same 16-bit CMOS processor, the 80C88, but there is 256K of RAM expandable to 768K. However, the entry-level Pro-Lite is a mains-powered machine. TI is offering a 5lb. clip-on battery pack which provides eight hours of power for under £200. A 720K 3.5in. drive is built into the side of the machine, with a second optionally available. TI offers a PC interface cable which lets you transfer files from an IBM PC or TI Professional. MS-DOS is included in the price. Volume shipments to the U.K. are scheduled for March.

For. IBM compatibility. Large memory. Built-in disc.

Against. High price. Portable version is quite heavy. New.

ALL THIS AND MORE

No 1 source for software

SOFT OPTION SOFTWARE CENTRE

NOW IN STOCK
WORDSTAR 2000
by MicroPro

Word Processing

WORDSTAR 2000 _____ by MicroPro
 WORDSTAR _____ by MicroPro
 MAILMERGE option for Wordstar _____ by MicroPro
 WORDSTAR/MAILMERGE Combo _____ by MicroPro
 SPELLSTAR Wordstar Spelling Checker _____ by MicroPro
 STAR INDEX (Indexing for Wordstar) _____ by MicroPro
 WORDSTAR Professional _____ by MicroPro
 Audio Training Tapes for WORDSTAR _____ by Sound Training
 SUPERWRITER _____ by Sorcim
 EASYWRITER (IBM-PC) _____ by I.U.S.
 EASYSPELLER (IBM-PC) _____ by I.U.S.
 WORD _____ by MicroSoft
 WORD with MOUSE _____ by MicroSoft

Communications

MOVE-IT Communications for CP/M-80 _____ by Woolf Software
 MOVE-IT Communications for IBM-PC _____ by Woolf Software
 BSTAM Inter Micro Comms CP/M-80, 86, PC _____ by Byrom Software
 BSTMS (Terminal Monitoring System) _____ by Byrom Software

Data Base and Data Management

dBASE II Relational Database _____ by Ashton Tate
 dBASE III _____ by Ashton Tate
 FRIDAY Ashton Tate Data Management _____ by Ashton Tate
 GRAPHICS for dBASE II/dBASE III _____ by Fox & Geller
 dUTIL Utility for dBASE II/dBASE III _____ by Fox & Geller
 QUICKCODE dBASE Code Generator II and III _____ by Fox & Geller
 EASY FILER (IBM-PC) _____ by I.U.S.
 DATASTAR Data Entry/Retrieval _____ by MicroPro
 REPORTSTAR Datarstar Report Generator _____ by MicroPro
 INFOSTAR (Datarstar + Reportstar) _____ by MicroPro
 CARDBOX (Data Management) _____ by Caxton

Financial Modelling and Spreadsheets

CALCSTAR Spreadsheet _____ by MicroPro
 PLANSTAR (Financial Modelling) _____ by MicroPro
 MULTIPLAN Electronic Worksheet _____ by MicroSoft
 SUPERCALC Spreadsheet _____ by Sorcim
 SUPERCALC 2 Spreadsheet _____ by Sorcim
 SUPERCALC 3 Spreadsheet _____ by Sorcim
 EASYPLANNER Spreadsheet (IBM-PC) _____ by I.U.S.

Miscellaneous

STARBURST System Integration _____ by MicroPro
 MILESTONE Project Planning (CPA) _____ by Organic Software
 FLIGHT SIMULATOR Game _____ by MicroSoft
 FAST GRAPHS Graphics for IBM-PC _____ by Innovative S/W
 BRAINSTORM (Ideas Processor) _____ by Caxton
 HARVARD PROJECT MANAGER _____ by Harvard Software
 GRAPHSTAT 1 (Statistics-Graphics) _____ by Holdene
 GRAPHSTAT 2 (Statistics-Graphics) _____ by Holdene
 GRAPHSTAT 3 (Statistics-Graphics) _____ by Holdene
 DATA PLOT + Graphics _____ by Grafox

Integrated Packages

OPEN ACCESS _____ by SPI
 FRAMEWORK _____ by Ashton Tate
 SIDEKICK _____ by Borland

Programming Languages

CBASIC for CP/M-80 _____ by Digital Research
 CBASIC for CP/M-86 _____ by Digital Research
 CBASIC for IBM-PC _____ by Digital Research
 CBASIC Compiler for CP/M-80 _____ by Digital Research
 CBASIC Compiler for CP/M-86 & IBM-PC _____ by Digital Research
 BASIC Interpreter for CP/M-80 _____ by MicroSoft

BASIC Compiler for CP/M-80 _____ by MicroSoft
 BASIC Interpreter for MSDOS _____ by MicroSoft
 BASIC Compiler for MSDOS _____ by MicroSoft
 Business BASIC for MSDOS _____ by MicroSoft
 C Compiler for CP/M86 PC DOS _____ by Digital Research
 C Compiler for MSDOS _____ by MicroSoft
 COBOL Compiler for MSDOS _____ by MicroSoft
 COBOL Compiler for CP/M-80 _____ by MicroSoft
 FORTRAN Compiler for MSDOS _____ by MicroSoft
 FORTRAN Compiler for CP/M-80 _____ by MicroSoft
 PL/I-80 Compiler for CP/M-80 _____ by Digital Research
 PL/I-86 Compiler for CP/M-86 & IBM-PC _____ by Digital Research
 PASCAL MT + for CP/M-80 _____ by Digital Research
 PASCAL MT +86 CP/M-86 _____ by Digital Research
 PASCAL MT +86 (IBM-PC) _____ by Digital Research
 PASCAL Compiler for MSDOS _____ by MicroSoft
 PRO-PASCAL Compiler CP/M-80 (Z80) _____ by Prospero
 PRO-PASCAL Compiler CP/M-86 MSDOS (PC) _____ by Prospero
 PRO-FORTRAN _____ by Prospero
 MACRO-80 ASSEMBLER for CP/M-80 _____ by MicroSoft
 MACRO ASSEMBLER for MSDOS _____ by MicroSoft
 ASSEMBLER plus tools for CP/M-80/86 _____ by Digital Research
 CIS COBOL _____ by Microfocus
 LEVEL II COBOL for MSDOS PC DOS _____ by Microfocus
 M2C BASIC (translate MBASIC to CBASIC) _____ by Digital Research
 ECO-CC Compiler for CP/M-80 _____ by EcoSoft

Utilities and Programming Aids

ACCESS MANAGER for CP/M-80 _____ by Digital Research
 ACCESS MANAGER for CP/M-86 & IBM-PC _____ by Digital Research
 DESPOOL Print Spooler for CP/M-80 _____ by Digital Research
 DISPLAY MANAGER for CP/M-80 _____ by Digital Research
 DISPLAY MANAGER for CP/M-86 _____ by Digital Research
 CLIP file compression/Winchester Backup _____ by Keele Codes
 SUPERSORT I for CP/M-80 inc. REL ver _____ by MicroPro
 SUPERSORT II for CP/M-86 & MSDOS _____ by MicroPro
 WORDMASTER Screen Text Editor _____ by MicroPro
 EDIT Text Editor for CP/M-80 _____ by MicroSoft
 SORT (Sort Utility) _____ by MicroSoft

Operating Systems

Concurrent CP/M-86 for IBM-PC-XT _____ by Digital Research
 CP/M/86 for IBM-PC-XT _____ by Digital Research

Books

TECHNICAL SUPPORT MANUAL _____ by MicroPro
 dBASE II FOR FIRST TIME USERS _____ by Ashton Tate
 EVERYMAN'S DATABASE PRIMER _____ by Ashton Tate
 THROUGH THE MICROMAZE _____ by Ashton Tate
 dBASE II FOR EVERY BUSINESS _____ by Ashton Tate
 THE REFERENCE ENCYCLOPAEDIA FOR THE IBM PERSONAL COMPUTER _____ by Ashton Tate
 DATA MANAGEMENT FOR PROFESSIONALS _____ by Ashton Tate

RING THE SOFTLINE
Grantham (0476) 860171

All products are supplied complete with full originator's documentation.
 Please send large s.a.e. for full details.



Soft option SOFTWARE CENTRE

The Soft Option (UK) Ltd. Home Farm House Colsterworth
 Grantham Lincolnshire NG33 5HZ Tel: Grantham (0476) 860171

Word processing for all reasons

Susan Curran introduces this month's special section and explains which WP package to buy for what purpose.

AS THE WORD-PROCESSING market becomes more crowded, a number of software developers are aiming their WP products at more closely defined groups of users. If you frequently send out large mailings, for instance, you probably need a different range of facilities from a journalist, scientist or translator. If you only want to produce an occasional letter or memo you probably need a simpler and more easily remembered package than a frequent business user doing more complicated tasks.

On the next few pages we take a look at WP packages intended for different uses. On page 112 Ian Stobie writes about word processing on the Macintosh, a machine which seems to inspire software writers to come up with new approaches to the major computing applications. And on page 110 Jack Schofield asks how good is word processing on the machines you can take anywhere — the lightweight battery-powered portables. Elsewhere in this issue Roger Cullis reviews WordStar 2000, the new package from the company responsible for WordStar.

Whatever the special use you plan for your word processor, certain general principles of good ergonomic design apply. If you are a newcomer to word processing then it is these that are going to matter most. You will probably find you are better off with a package designed for easy operation than with a monster which has a manual as thick as the phone book.

Ideally, a word processor should allow you to switch on the machine and turn out a reasonable letter or memo in half an

hour at most, even if you have never used the package before. It should also enable you to produce complex work using most of the major features on an occasional basis. And you should be able to grasp every feature that the program offers without taking a year-long training course.

All these qualities depend upon good ergonomic design. Easy word processing has little to do with how much the program offers; it is not synonymous with limited word processing. But the practicalities of programming, and the minds of programmers, do often mean that the programs with a small range of features are easier to work with.

Easy to follow

If you plan to be a genuinely infrequent user, then your prime requirement will be an easy-to-follow program with plenty of prompts and help available. This too is not synonymous with ease of use. To the regular user, ease of use means streamlined, sensible command sequences. And the regular user should be prepared to put more effort into mastering the program initially, while the occasional one is really beginning from scratch each time.

For occasional users, the best approach is still the menu approach. Recently the trend has been towards pop-up menus on the main editing screen, not separate full-screen menus. Mnemonic letters are not always a good idea; in order to use all 26 letters, some programs resort to unlikely mnemonics, and the assignment varies widely from program to program.

You need reasonably full descriptions

of the features provided, not idiosyncratic or cryptic ones. If there is only room for brief descriptions they should be amplified in Help screens. There should also be a graceful and self-evident escape route from incorrect choices — especially those which have a drastic effect like Load, Merge, Delete, etc. Alphabetical menus are used on Select and Quill, among others.

A few computers have function keys labelled with word-processing functions — the Torch, the Wang Professional and the Eagle, for example. So long as the program is fully installed to make use of them, this is an easy approach, particularly for anyone who cannot touch-type. Touch-typists often find it difficult to locate function keys and prefer control-key combinations, such as Control-D for Delete instead of a special Delete key over on the side of the keyboard.

Keyboard templates are a necessary evil at best. It is not easy work with a template, particularly if it does not fit securely on to the keyboard. Occasional users waste a lot of time searching the template for the key in question.

Mice are less appropriate to word processors than to some other types of program, because you need to use the keyboard intensively to type text. But they do save having to learn complex sequences of Fast Move and Slow Move cursor commands, and they let you make menu selections quickly and easily. The mouse approach at its smoothest is in Macwrite, which is very easy to use, though not par-

(continued on next page)

Basic WP

	Micro	Supplier
Bank Street Writer	Apple, Atari, CBM 64, IBM	Softsel
Homeword	Apple, Atari, CBM 64, IBM	Softsel
Jane	Apple, IBM	P&P
Quill	QL, IBM, MS-DOS	Psion
Leading Edge	Apple, IBM	P&P
Macwrite	Macintosh	Apple
Multimate	IBM	Softsel, P&P
PFS Write	Apple, IBM	Softsel, P&P
Select	IBM	Mayfair
Vizawrite	CBM 64	Viza
Volkswriter Deluxe	IBM	Softsel
Wordwise	BBC	Computer Concepts

For authors and journalists

	Micro	Supplier
Macauthor	Macintosh	Probe
Macwrite	Macintosh	Apple
Microsoft Word	IBM, Macintosh	Softsel, P&P
Multimate	IBM	Softsel, P&P
Perfect Writer II	IBM, MS-DOS	Thorn EMI
Book Machine	ACT	Prefis
Superwriter	IBM, MS-DOS, CP/M, CP/M-86	Sorcim
Tea	CP/M	Colossum
Word Perfect	IBM, MS-DOS	Softsel, ACT
Wordpro series	CBM-64, all Pets	Wego
WordStar	CP/M, IBM, MS-DOS	Micropro
WordStar 2000	IBM	Micropro
Vizawrite	CBM 64	Viza

Scientific and foreign text

	Micro	Supplier
Arabstar	IBM	Aptec
Displaywrite II	IBM	IBM
Framework	IBM	Ashton-Tate
Lotus 1-2-3	IBM, MS-DOS	Softsel
Macwrite	Macintosh	Apple
Spellbinder	IBM, CP/M, MS-DOS	Sierra, Encotel
Spellbinder/Arabic	IBM	Sierra
Spellbinder/Scientific	IBM, MS-DOS	Sierra, Encotel
Symphony	IBM	Softsel
Superwriter	IBM, MS-DOS, CP/M, CP/M-86	Sorcim
Volkswriter Deluxe	IBM	Softsel
Volkswriter Scientific	IBM	Softsel
Vuman	ACT	Vuman
Wordwise with Languagewise	BBC	Computer Concepts

Output that impresses

	Micro	Supplier
Lisawrite	Lisa, Mac XL	Apple
Macwrite	Macintosh	Apple
Microsoft Word	IBM, MS-DOS, Macintosh	Microsoft
Perfect Writer II	IBM, MS-DOS	Thorn EMI
QXText	Epson QX-10	Epson

(continued from previous page)

particularly powerful. Microsoft Word is more powerful and correspondingly less easy to learn.

Disc-based training courses tend to be faster to use, more flexible and a more positive introduction to the program than a manual course can be. A manual course is a passable second-best: too many fat manuals do not provide one, and many more lack one that is suitable for users already familiar with other word-processing programs.

Simple disc-based courses are provided as part of the package with, among others, Select, Multimate and Volkswriter Deluxe. They provide a reasonable guide through the basics, and are adaptable in varying degrees according to evaluation of the user's progress and, of course, the user's choice of important features. Some independent companies offer training courses, either disc-orientated or more general hands-on, for other popular word processors.

Most people like the WYSIWYG — what you see is what you get — approach. In fact, there are three main classes of program. First, there are programs where everything is echoed on screen — the justification, the double spacing, the bold print and so on. No control codes are employed. This looks snazzy, but makes life very difficult if you want to do something that is not reproducible on screen. Frequently you find you can't. Microsoft Word and Quill work on these lines.

Secondly, there are programs which reproduce the general layout of the text on-screen without attempting to reproduce special print modes, which are handled by control codes. On many good programs, including the WordStar family,

Displaywrite II and Olivetti word processors, it is possible to choose between viewing the codes, or suppressing them to check on the final layout. This is my preferred approach. Some programs use graphics control codes whose meaning is not immediately apparent. A good program will provide an on-screen key to the meaning.

Finally, there are programs where all formatting is handled through control codes, or in a separate print-formatting routine. The screen display bears little relation to what appears on the paper. Though there are plusses in this approach for heavy-editing regular users, there are none for the occasional user. Avoid programs which do this, like Perfect Writer and others of the Emacs school.

It always helps to have a ruler on screen to show where tabs and margins are set.

Not all rulers show tabs and margins. Those on WordStar 2000, for example, do not handle different type pitches correctly. Ideally, a new ruler should appear in the text wherever the settings are changed, and the program will remember the settings for each section during subsequent edits.

It is very difficult to achieve true WYSIWYG on a 40-column screen, as used on many home computers; typical text lines contain more than 40 characters. Some programs try to achieve it by scrolling across the text, which does not make life easy when it comes to reviewing what you have written. Among the alternatives are a quick reformat between editing and printing — this works well in Vizawrite on the Commodore 64 — and a separate view screen or section to show how things will look, as used to good effect by Wordwise, on the BBC B, for example.

Boilerplating and mail-merge

	Micro	Supplier
Alphatext	Alphatronic PC	Triumph-Adler
Displaywrite II	IBM	IBM
Framework	IBM	Ashton-Tate
Microsoft Word	IBM, MS-DOS, Mac	Microsoft
Oliword	Olivetti M-20, M-24	Olivetti
Scripsit	Tandy	Tandy
Spellbinder	IBM	Encotel

Doing it on the cheap

	Micro	Supplier
Amsword	Amstrad	Amssoft
Atariwriter	Atari	Atari
Bank Street Writer	Apple, Atari, CBM 64, IBM	Softsel
Bonny Blue	IBM	Paperlogic
Easyscript	CBM 64	Precision
Homeword	Apple, Atari, CBM 64, IBM	Softsel
Merlin Scribe	BBC	Merlin
Quill	QL, IBM, MS-DOS	Psion
Scripsit	Tandy	Tandy
Tasword II	Spectrum	Tasman
View	BBC	Acornsoft
Vizawrite	CBM 64	Viza
WordStar — if bundled	Sanyo, Osborne, etc	Micropro
Wordwise	BBC	Computer Concepts

Suppliers

Aptec: 01-328 7272
 Acornsoft: Cambridge (0223) 316039
 ACT Pulsar: 021-501 2284
 Amsoft: Brentwood (0277) 230222
 Apple: Hemel Hempstead (0442) 60244
 Ashton-Tate: Milton Keynes (0908) 568866
 Atari: Slough (0753) 24561
 Colossus: 01-435 9321
 Computer Concepts: Hemel Hempstead (0442) 63933
 Encotel: 01-680 6040
 Epson: 01-902 8892
 IBM: 01-578 4399
 Mayfair Micros: 01-870 3255
 Merlin: Swansea (0792) 467980
 Micropro: 01-879 1122

Microsoft: Windsor (07535) 59951
 Olivetti: 01-785 6666
 Paperlogic: 01-935 0480
 Precision: 01-330 7166
 Prefs: Ware (0920) 5890
 Probe: 051-423 6666
 Psion: 01-723 9408
 Sierra Systems: Epsom (78) 29375
 Softsel: 01-844 2040
 Sorcim: Watford (0923) 46255
 Tandy: Walsall (0922) 648181
 Tasman: Leeds (0532) 438301
 Thorn EMI: Farnborough (0252) 543333
 Triumph-Adler: 01-250 1717
 Viza: Medway (0634) 813780
 Vuman: 061-273 5315
 Wego: Caterham (0883) 49235

We would like to thank RAK Computers Ltd of Norwich for the loan of machines to test programs for this feature.

For authors and journalists

SURPRISINGLY few word-processing programs are promoted particularly for authors and journalists; perhaps it is that we are a small market compared to professional secretaries and typists. However, we have quite different needs, and some programs meet them far better than others.

Most dedicated word processors are aimed at audio or copy typists who work through page by page, typing in prepared text, and then work through again sequentially to make corrections or revisions. The emphasis is on making this routine task easy.

Writers, by contrast, may want to start with rough notes and work slowly up to finished copy. Many expansions, revisions and changes of order may be made on the way. The program has to be robust enough to cope with massive changes in the text without either crashing or dropping to a snail's pace.

Popular WordStar

Whatever WordStar's other failings, it meets this requirement with ease — hence its continuing popularity. Superwriter does too, and the same applies to Perfect Writer once you have learnt to avoid the bugs. A few programs work in one direction only: for example, it is only possible to work forwards through long disc-based files using Spellbinder.

Many writers find it difficult to work with a page-based system, where it is impossible to see the bottom of one page and the top of the next on-screen at the same time. This is largely true, for example, of Displaywrite II and of several other recent word processors for the IBM PC. Page orientation seems to be in vogue. The plus point which may outweigh the disadvantage is the ability to go to any page without fuss, which is a real boon in a long document.

Journalists may value the offer of a separate scratch pad area on which notes can be stored. Several Commodore 64 word processors do this, including Viza-write and Wordpro 3 Plus/64. Multiple document handling is available with Perfect Writer and other Emacs programs, Microsoft Word and Macwrite. This offers a chance to compare drafts displayed in different screen windows and is an even greater help.

An interesting approach particularly aimed at writers is the tree-linked file system on TEA, a new program from Colossus Software which runs on the BBC with Acorn Z-80 processor, Research Machines 480Z and a motley collection of other micros. From here you can trace a loosely charted route away from word processing, via thinking-aid programs like Brainwave, into database territory.

Ideally it should be possible to hold your entire article, chapter, book or whatever in a single file. It is surprising how many systems will not handle long files, and many others will do so only reluctantly. For the author trying to wrestle a long chapter into shape, the ability to link short files in a print queue is really no substitute.

A common maximum length on RAM-based programs is less than 10 pages of single-spaced A4 text. The Gemini word processor for the BBC handles only two pages, and Macwrite will not cope with more than 10. It might be supposed that the trend towards larger memories would solve this problem, but it seems only to have led to longer and more loosely written programs. Over 100K of code is now quite commonplace, and memory can become scarce even on a computer with 192K or 256K. The problem is acute on the Sinclair QL, with 128K, nearly all of which is taken up by screen memory and Quill.

Safety first

If you handle long documents it is important to ensure that the program can deal with them safely. The Multimate approach, in which successive pages are safely stored on disc, is an excellent one. WordStar and many other programs that juggle text between memory and disc can leave you in the awkward situation where your edited file simply will not fit back on the disc. It is certainly no joke if that file represents a day's work that you thought was complete.

Equally important is the need for controls that let you zip around the text from page to page. Many programs suggest that you use Search and Replace for this purpose, but for my money it is not an ideal tool. Page-based systems score here, as is recognised in WordStar

2000, for example. If you opt to work with short, linked files, then it is important to ensure that the program can link them effectively, can Search and Replace through all of them, and can number pages on successive files, starting at 1 or at any other number you may require.

Equally valuable is the ability to merge data from different files, and to save parts of a file as separate documents. A few programs, like Tandy's Scripsit, make this impossible. Many are more orientated to a boilerplating paragraph approach and will object to shuffling very large blocks of text.

Double spacing

Authors and journalists need to double-space their manuscripts so it is important to find a program that will handle double-spacing efficiently. Double-spaced text on-screen is not always a help: it looks reassuringly normal, but halves the amount you can read at one go. Many publishers will accept one-and-a-half spacing, which saves a fair bit of paper. Not all programs offer it. On some programs, it is possible to switch the text from single to double spacing with a single command sequence. On others, it is necessary to reformat paragraph by paragraph.

A word-count facility is also important. Several programs are incapable of producing a word count quickly and effectively. Among them are WordStar and Microsoft Word.

Automatic footnote handling may sound tempting but in practice it can be difficult to set up. Not all programs handle footnotes in the ways that publishers like to see them. Such facilities tend to be orientated more towards word-processed reports than to typescript that is later to be set in print. Similarly, I do not find automatic indexing particularly helpful myself, as the typescript page numbering will inevitably differ from the proof page numbering. If you produce academic or scientific text you may find such features more of a help.

These features do come into their own, of course, if your publisher uses the same system for typesetting as you use for writing. One system that encourages this way of working is Prefis's Book Machine, a system aimed at both publishers and authors. The author version is a full-blooded word processor which copes with varied type styles and indexing, and includes a draft comparison feature. Pass it on to a publisher using the system, and your text can go straight on to typesetting equipment. The Book Machine runs on Apricot micros and is generally sold as a complete hardware/software package at around £5,600.



Scientific and foreign text

SCIENTIFIC REPORTS and foreign-language documents have one feature in common: they both make use of non-standard symbols and characters. If you produce this type of material you will need a word-processing system that specifically enables you to produce special symbols. Scientific word processing has some other special features too.

Characters appears in three different places: on your keyboard, on your screen and on the page that emerges from your printer. Ideally, you press a key marked with the character you want in your document, see it appear on screen, and have recognisably the same character appear on the printout. If a character you wish to use does not appear on your keyboard, you may be able to put it there by using a template or buying a foreign-language keyboard. It is often easier and cheaper for you to get used to pressing one key, and seeing a different symbol appear on screen. An alternative is to work with the same keyboard and screen symbol, and to generate the different symbol you want on the printed output only.

Alternative keyboards

International and fairly up-market micros like the IBM PC family offer different international keyboards. If you work all the time in Spanish, say, then the obvious answer is to order a Spanish keyboard; it may be simplest to buy a computer in Spain. You must then ensure that your word-processing program uses this keyboard configuration, and reproduces the right character on-screen, and that the printer driver reproduces it on the printer.

If you work only occasionally in Spanish, French, Norwegian or whatever, then you need a utility that allows you to select different key configurations on request. You press the same old key, but a different symbol appears from the screen onwards. Displaywrite II on IBM PCs is one program that does this. There is a choice of alternative key configurations, including European-style foreign-language characters, Greek letters and common scientific symbols.

A much cheaper system that has the same capabilities is the Wordwise/Languagewise combination for the BBC model B. Languagewise is a separate program from Dataware that works with Computer Concepts' Wordwise. It sets up additional accented and currency characters for 12 families of foreign languages, including Albanian and Turkish; it does not cover Greek, Russian or other non-Roman alphabets. The characters are substituted for less often-used keyboard symbols, and they appear properly in preview mode — but not in the mode 7 that

For this sample, I defined a box within the Easy Script program, and now use it to print with:
Is the capital of Italy:

- Florence
- Rome
- Naples

Tick the answer you choose.

User-defined outline boxes on the Epson FX-80 using Easy Script on a Commodore 64.

Paulin Ne troublez point le cours de votre renommée
Déjà de vos adieux la nouvelle est semée;
Rome, qui gémissait, triomphe avec raison;

Printing on an FX-80 set to the French character set, using WordStar on a Torch.

Here are the inbuilt Epson FX-80 (and similar printer) subscripts and superscripts. These neat half-sized fonts are very handy for printing simple equations, e.g.



	superscript		
Normal text		normal text	subscript
In an equation, this is less neat than the Epson version:			
CH	(COOH)	+ Br	-> CHBr(COOH)
2	2	2	2

There are two ways of producing subscripts and superscripts: by switching to a half-size font (top); or by feeding the paper up or down a line or half a line (bottom).

Wordwise uses for editing — and on an FX-80 printer.

A simpler option is to use the same old computer and program, but adapt your printer. You can get new characters on a daisywheel printer simply by slotting in a different daisywheel. New characters on a programmable matrix printer can be constructed by sending control codes or setting DIL switches. So long as the new character is accessed by a code that the keyboard generates, there is no problem.

Sometimes this is not the case, even with the humble £ symbol. Then you must send the ASCII code in a direct form. Some word processors allow you to do this; many, particularly the up-market ones aimed at secretaries, do not. Superwriter — son of Magic Wand by Peachtext — on

the IBM and compatibles will do it, for example; WordStar will not.

Most Epson printers and similar matrix machines have eight or nine international characters sets; some include Japanese Kana characters. You can select one either initially using DIL switches, or in mid-print using control codes. On programmable matrix printers you can design your own characters as well, using either keyboard or non-keyboard codes for them. You run a program to set them before using your word processor. Amend the printer initialise routine, if necessary, so that your good work is not undone.

Most reputable word processors handle subscripts and superscripts. If you think you will need them, check that your chosen package will produce them. For complicated equations, it can be useful if you can set up several levels, using sub-subscripts and super-superscripts.

The programs most inclined to include simple maths are those derived from dedicated word processors, like Displaywrite II and the Wang WP program. There is also a touch of the calculator in Wordsworth for the BBC model B. My feeling is that these features are not much use to scientists. The maths is strictly orientated to simple report production: averaging and totalling columns, for instance. In general, there is more to be said for a program that can import calculations from a spreadsheet. Many will do so, though with varying ease, and of course there are word-processing elements in spreadsheet-orientated integrated packages such as 1-2-3, Symphony and Framework.



Output that impresses

WITH SOME word processors, the accent is on giving the user as much freedom as possible to compose and edit a document. With others, it is very firmly on high-quality presentation, and a variety of systems are available which emphasise the appearance of the printed document.

Presentation on-screen is important, particularly for those who handle electronic mail. For most users, though, it is printed presentation which matters. Not all programs which pay detailed attention to print make any attempt to reproduce the print styles and/or the final format on-screen.

Letter-quality print primarily means daisywheels, though there are other types of up-market printer, such as expensive ink-jets and laser printers. Daisywheels provide high quality at the expense of some versatility. They are not suitable for graphics-orientated output.

With a daisywheel, you can only reproduce the characters that are available on the print wheel. Good printers offer a variety of different wheels, and there should be a fair range of scientific symbols, foreign-language characters and so on available on specialist wheels. The most common variation is in fount.

Limited range

Basic print commands vary little, but the control codes for accessing special print features tend to very specific. A word processor that supports special features will do so only for a limited range of named printers. The ranges vary from program to program: among the most popular are the NEC Spinwriter, Qume Sprint, Diablo and Xerox machines. They are all comparatively expensive. Cheap daisywheels do not offer the same type of feature, and you will not be able to extract similar quality output from them.

Most WP/printer combinations can handle simple justification by dint of adding extra spaces between the words, distributed along the line as evenly as possible. A much neater effect is created if the letters can be distributed evenly along the line, using smaller spacing increments. Many printers manage spaces as small as 1/120in., compared to the 1/12in. of an ordinary 12-pitch space. This is known as microspace justification and is offered — on a limited range of printers — on most up-market WP programs.

A more advanced form of micro-space justification handles proportional spacing, and will leave less space around an i than around w. This is not a common feature. It is available on some specialist print programs, such as the U.S. Magic-print which links to most MS-DOS word processors.

Most matrix printers offer a few alter-

With daisywheel printers, a switch of daisywheel gives you a new font. On mine, it's possible to select the pitch independently, so that this passage, although in Prestige elite which is intended at as 12-pitch typeface, is printed in 10 pitch.

This paragraph is in Courier, a popular 10-pitch font. Contrast passages in a slightly different font like this could be used as a subtle way of enhancing presentation.

Tile Italic font can be used at either 10 or 12 pitch. I find it useful as a 'computer-like' font for program listings, as well as for normal italic contrast.

Most printers which support proportional spacing have a pitch setting switch of some kind. This is printed from Wordstar on a Tandy daisywheel using the Madeleine proportional spaced font. Wordstar is set to normal 10-pitch output, but the printer setting overrides this, and proportional print emerges. As it is not possible (at least on my system) to justify proportional spacing, this passage is not justified.

Top: On daisywheel printers you have to physically exchange daisywheels to change founts. More subtle effects can be produced by altering the pitch, or number of characters printed to the inch.

Bottom: Proportional spacing is handled as a printer-controlled feature on many daisywheels, and you need no special word-processing capabilities to produce it. The example shows proportionally-spaced type on a Tandy daisywheel using WordStar set to 10-pitch type.

native type styles, such as pica, elite and italic. On a programmable matrix printer it is possible to produce other type styles by bit-image programming. Though the result can be quite snazzy, it still has a dot-matrix look to it which does not appeal to many business users.

You can get a lot out of a matrix printer by Basic programming, but comparatively few word processors will do the hard work for you. The task is much simplified on the Epson QX-10, with its 16-fount on-screen and on-printer capability. QXText handles the lot with reasonable aplomb.

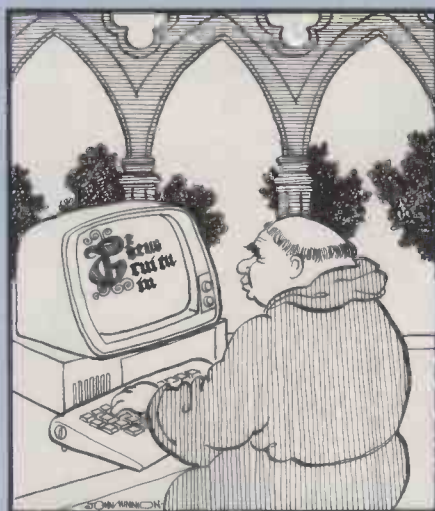

More popular nowadays is the Apple Macintosh, which produces amazing output on-screen and on the Apple Image-writer. Among Macwrite capabilities are a variety of fount styles and print sizes, and stylistic variations such as italic, outline and shadow printing. It is also possible to combine Macwrite output with diagrams and illustrations produced by the Macpaint package.

Special requirements

Electronic mail has some special requirements. The ideal output is a simple ASCII text file, unadorned by unlikely control sequences. It should then be possible to read it both on your own word processor and on a quite different word processor that your recipient may be using, or directly from the operating system as a text file. Some word processors will produce output files in two flavours: with control codes for printing, and in ASCII format without control codes for electronic mail or for use in other programs. This is a handy feature, even if you see no immediate need for it.

Reports intended for distribution in typed form will be much improved if your word processor can handle a variety of different headers and footers. A feature missing from some programs is provision for alternate odd/even-page headers and footers. Useful too are alternate odd/even left and right wide margins to simplify binding.

Some programs orientate themselves particularly towards report production, and will handle automatic numbering of paragraphs, automatic footnote placement, and the compilation of contents pages and indexes. Perfect Writer is a prime example. It is powerful, but not very transparent, and only an experienced user will avoid the occasional nasty surprise.

Boilerplating and mail-merge

SOME FIRMS produce form letters on a truly monumental scale. These suggestions are mainly for those doing it more modestly, not for credit-card companies or magazine promoters.

"Boilerplating" is the name given to glueing together a selection of standard paragraphs to produce an individual document. It is quite different from mail-merging, in which you merge a skeleton letter with a file of variable information giving successive names, addresses and other specific information to be incorporated into it. At the top of the scale, the two combine to produce sophisticated capabilities where different form letters can contain different sequences of paragraphs.

Large-scale boilerplating comes into its own in solicitors' offices, where very similar documents are built up repeatedly out of standard paragraph building bricks. On a smaller scale, most word-processor users find that they repeat the same text again and again in different contexts. We all have regular correspondents, for instance, whose names and addresses do not alter from letter to letter.

Repetitive letters

Take, for example, a pretty typical word-processing task: a business letter. The date will be repeated on maybe 20 letters written that day. The correspondent is a regular client to whom a letter is written perhaps once a month. The first couple of paragraphs are unique, but the third — perhaps details of a new product or of new credit terms — needs to be repeated more or less verbatim on all letters to clients over a fixed period. Taking all these elements together, a large proportion of the letter content is repetitive. Producing the letter can be simplified if the date, the address and the standard paragraphs are all held on disc in files that can be accessed with a minimum of keystrokes.

It is possible to combine sections of text on most word processors simply by giving a Merge Files command and then the name of the file in question. But often the number of keystrokes involved and the time taken are disproportionate to the length of a short piece of text, such as an address. A handy way of simplifying the job is by using a special quick-access library of words, phrases or paragraphs.

On some systems, short words or phrases are referenced by simple keystroke combinations such as Control-number or Escape-number combinations. There will be a maximum of maybe 10 or 20, enough to allow you to set up a few short pieces of frequently used text, which may be from a long word to an address in length. They are held in RAM, though ideally they

should be stored on disc too, and can be called up instantly. I used this system on Scripsit and have mourned its lack on most other word processors ever since. I have also encountered it on Alphatronic and Olivetti word processors.

The Olivetti system is one of several that uses double-level access. You set up both a short-phrase library and a larger disc-based long-paragraph library with up to 100 entries. This can be used for a fairly small library of standard text paragraphs, for instance, or for a small database of names and addresses.

Space-saver

Some such systems read the stored text into a new document. Others don't bother: the document simply lists cues for printing the sequence of paragraphs. You do not get a preview of the print layout with this method, but it does cut down the size of documents and saves disc space. Displaywrite II works on these lines.

You can handle simple form letters manually on just about any system by setting up a skeleton letter file on disc, reading it into memory, and then typing in the variable information. It helps if the word processor has an Overprint mode, so that the original layout is preserved.

Doing this, you need to type all the names, addresses, etc., or to read them individually from other files. A more efficient arrangement sets up a name-and-address file, from which data is read set by set into the letter skeleton. This is what is generally meant by a form letter or mail-merge capability.

The simplest such systems expect your variable information file to be strictly sequential. Each word or sentence from it is used once, and slotted into the letter skeleton in the order in which it is read from the file. The cheapest workable system that I know of along these lines is

Wordsworth for the BBC, which costs around £22.

The system has one strict limitation: data from the variable file can be read into only one place in the skeleton, though it can be of any practicable length. More advanced systems allow you to reproduce the same information from the file at several points in the letter, or to shuffle the order. This capability is available on most business-orientated word processors.

This approach is not much use if you want to vary the list of addressees to whom you will send letters: picking, say, clients with overdue bills, or clients who do more than a certain amount of business, or club members whose subscriptions are due in a particular month. Good systems allow you to set up a single variable list and then to mark sets for inclusion or exclusion in a particular form-letter run. This can be done manually by typing an Ignore symbol before unwanted entries in the file, or by keying Yes/No as the addresses are displayed on screen. Alternatively, it can be done automatically, according to the If-Then criteria you give.

Like a database

The more sorting and selecting you need to perform on your variable list, the more it comes to resemble a database. In fact, the common approach is to leave sorting and selecting to a database program, and to have it compile a variable list which is fed into the word processor. You can do this either with sets of inter-related programs, or with all-in-one programs combining word processor and database, or with some unrelated programs that use a basic ASCII file structure.

Many mailing-list orientated database programs do themselves provide sufficient word-processing capability to allow you to turn out a short form letter. Busipost is a good business-orientated example. Few will handle letters over a page in length, and editing facilities tend to be primitive. Some mailing-list programs actually produce addresses on sticky labels only and it is difficult to compile a sequential file from them. Several BBC programs are prime offenders here.

Mail-merging sounds straightforward enough, but the way in which it is implemented makes it a horrendous task on some systems. Ease of use is an important criterion. If the program does not have the in-built capabilities you want you can sometimes program them in. Programming facilities that could produce tailor-made mail-merging are included in Spellbinder, using the Macro approach, in Framework and some other integrated packages, and in programmable databases such as Superbase on the Commodore 64 and newer Apples.



Doing it on the cheap

IF YOU ARE a truly lousy typist, any word processor may be better than nothing. At least it will help you to turn out a mistake-free letter. For regular use, though, there is a minimum below which no sane person would drop. The systems mentioned here all come above that minimum. Though not up to professional office standards, they serve well for serious home applications, for small businesses operating on a shoestring, and for hard-up authors and journalists.

In order to word process you need a disc drive or two, or at a real pinch a Microdrive; cassette storage will not do. Add to that the cost of the computer itself, a monitor, a printer and possibly extra cables and interfaces. Budget for all these, and for your program. Do not economise too much on the program; a good program with a cheap printer is better than a lousy program and a more expensive printer.

To start with the cheapest of the cheap, the only WP program under £20 that I have ever tested and would use myself is Tasword 2, which runs on the Spectrum and Spectrum Plus. It sets up a 64-column screen which is just legible on a portable TV and handles interfacing with Centronics printers.

Though not sophisticated, it does make editing practicable. Using Tasword 2 with Microdrives and a cheap matrix printer you could set up a basic system for somewhere around £500. A full 80-column version of Tasword, called Amsword, is also now available for the Amstrad CPC-464.

I have tried many other cheap programs for home computers, and cannot recommend any of them. They make editing a real chore. Even the more passable in the £20 to £40 range, like Wordsworth on the BBC and Simply Write on the Commodore 64, are markedly less efficient than those costing more.

Commodore 64

The drawback of the Commodore 64 is its 40-column screen. It is possible to get an 80-column adaptor, but it is expensive. Doing 40-column word processing is much harder work than using 64 or 80 columns as you never see all of what will appear in print at once, in its final layout. Its substantial memory makes the Commodore 64 a fair, cheap word-processing computer. I recommend a non-Commodore printer with an interface. The interface may cost up to £100, but you can keep using the printer when you upgrade the computer, as you surely will. Unfortunately, there is no practicable alternative to the dreadful Commodore disc drives.

Several 64 programs do not provide wordwrap, which makes reviewing text

more difficult. Otherwise, the standard is generally good. Vizawrite is my own favourite: it has wordwrap, scrolls sideways, reformats quickly and easily, and reads files from other programs. Easy Script is also very usable. The all-time turkey is Quick Brown Fox — not recommended at all.

Atari

The Atari machines have never figured seriously as serious home or cheap office micros in the U.K. But their prices are low, their word processors good, and their disc system a great improvement on Commodore's. Among the worthwhile offerings are Atariwriter and Bank Street Writer.

BBC

If only the BBC had more RAM free, it would be a clear winner even at its exorbitant price. As it is, 80-column word processing is only possible with a memory extension like the Aries RAM board, or an expensive second processor. A few programs offer 80 columns without either: however, they handle only a couple of pages of text at a time.

The ROM programs are generally the best, the easiest to use and the most expensive. Wordwise is well supported with spelling checkers, language extras and the like. It is simple, fairly powerful and reliable. View has recently been improved and scores for its handling of form letters. Merlin Scribe copes with long files on disc. All three are recommended.

QL

QL word processing currently means Quill, the Psion program bundled with the machine. It has been much maligned, and indeed the early versions were too bug-ridden and too slow to be recommendable.

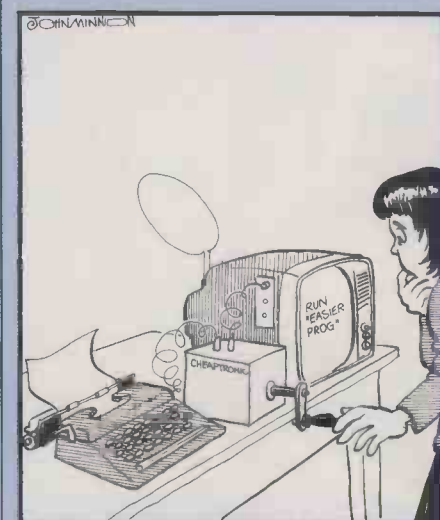

However, the program is superbly designed, with clear menus, good help facilities, sensible editing commands and an excellent and versatile screen display. If the faults are reduced on subsequent issues, Quill could yet make it as a major contender in this field.

CP/M

With the switch from eight-bit to 16-bit machines in the business market, the original eight-bit CP/M operating system has gone down-market. The Z-80 based computers supporting CP/M are not much more expensive than the more home-orientated micros mentioned, and they make excellent choices as cheap word-processing engines.

Quantities of competent CP/M word processors emerged in the late seventies and early eighties, and most of them compare very favourably with the home-computer opposition. The drawback is the price. Hoary old WordStar for CP/M still costs £295, which is way out of line with the likes of Wordwise at £46. Hence it makes a lot of sense to locate a bundled package with word processing, spreadsheet and the like thrown in.

An obvious choice as a cheap CP/M micro is the Amstrad CPC-464 with a disc drive, but there are no freebies currently on offer here, which is important. The Sanyo MBC, for example, costs around three times as much on the surface, but the difference is much less when you add on disc drives; WordStar and many other goodies also come free with the Sanyo. Another option is the BBC Micro with an Acorn or Torch Z-80 second processor. Both provide bundled software.

WordStar is not easy to learn, but it is powerful and very reliable. A great many letters, articles and books — mine included — have been written using it. I prefer it to the opposition, but most of the popular programs are perfectly adequate.

Bargain basement

If you have no urge to run 1-2-3 or other recent marvels on your micro, you can find bargains among outdated CP/M machines. Be cautious in arranging servicing deals, particularly with bankrupt stock or second-hand machines, unless the computer is so cheap that you can afford to throw it out when it goes wrong.

Tandy has recently offloaded much of its stock in the wake of the recent Apricot tie-up, and can be relied upon to keep servicing its products efficiently. Some Tandy computers may still be around at rock-bottom prices. Most of the bigger machines run CP/M or MS-DOS, but on those that do not Scripsit is a worthwhile in-house alternative.

On the move

Waiting time can be made productive if you take your computer with you. Jack Schofield investigates word processing on a portable.



DG's battery-powered One runs full-scale office word processors.

IF YOU SPEND much time in airports, railway stations, small hotels or travelling in the back of a cab, a portable micro can quickly pay for itself by turning wasted time into productive time. One of the ways it can do this is by providing the opportunity for text entry, or even word processing, while on the move.

Portables vary greatly in range and power — see Top Ten Portables on page 99. However, they can all be used for word processing, as long as they have a good-quality keyboard. The other useful attributes for word processing on the move are battery power, a legible screen and a ROM-based word-processing program. A built-in modem can also be an advantage, but because of the time and cost involved in securing approval for modems they are not as common as they might be.

Batteries for mobility

Battery power is important because the need to rely on mains power greatly restricts the range of places in which a portable can be used.

Screen legibility is especially important. Most portable micros use LCD, liquid crystal display, screens which are not self-illuminated like standard monitors and electroluminescent displays. The legibility of an LCD screen depends almost totally on the quality of the ambient lighting. The lighting in trains, boats, planes and even hotel rooms is generally far below office standards.

A ROM-based word-processing program is also a great advantage because this makes the software instantly available. With some machines you can be ready to type a document within two or three key-strokes of turning the power on.

With ROM-based portables, the text is often held in battery-backed RAM, which also adds to the convenience. When you need to stop writing you can just turn the power off, without needing to save the text to tape or disc. It is saved automatically for as long as the batteries last.

The major disadvantage of this approach is, of course, that RAM quickly gets full, which is where the modem comes

WordStar will run on the Epson PX-8; the 80-column screen is a major plus.

in. Using a modem or an acoustic coupler with an ordinary telephone you can upload your documents either to a public electronic mail service such as Telecom Gold, or to another computer fitted with an auto-answer modem at your home or office.

However, if this is not possible, a portable micro will save documents to a standard cassette recorder. Some of the Walkman-type personal stereo products and microcassette recorders intended for dictation can be used instead, as long as a suitable cassette cable is available.

At the simplest level, a portable micro can be used as a text-entry device for typing in notes, parts of reports and the substance of letters. Using a null modem cable — a modem cable with lines 2 and 3 crossed — the text can later be transferred to a desk-top machine for word processing and the final printing out. There are two reasons for adopting this approach. First, portables tend to have only small screens. Second, ROM-based word processors tend not to have very many facilities, especially when it comes to print formatting.

Only 50 words

The main limitation of lightweight portables like the Kyocera-built Tandy 100, Olivetti M-10 and NEC 8201a is that the screen provides only eight lines of 40 characters. This means you can only see about 50 words at once — roughly a single paragraph. The narrow width makes it difficult to compose anything which requires a formal layout. A business letter, for example, will normally be at least 64 characters across and be laid out to print across 80-column paper. The limited depth of only eight lines makes it difficult to compose a report of any length, simply because of the difficulty of seeing the overall shape and scope of your work.

The word-processing programs built into small portables like the Tandy 100 and Olivetti M-10 do not offer all the features of, say, WordStar. This is hardly surprising as they pack the word processor, a simple file-handler, the Basic language, an operating system and a telecommunications program into a mere 32K. Thus they provide only for relatively simple text operations such as Save and Load, Find, Select, Cut, Paste and Copy. The cursor can be moved by letter, by word, by line and by a screen at a time, but not by sentence, by paragraph or by page. You can jump to the top or the bottom of a text, but finding anything in the middle can be tricky. One technique is to use Find to search for a remembered phrase.

If more sophisticated facilities are required, they can be added by loading a program from tape. If the text has already been entered you can use Autopen from Microtime International, or M-10/Texted from Olivetti, to format it for printing. There are also numerous enhanced word



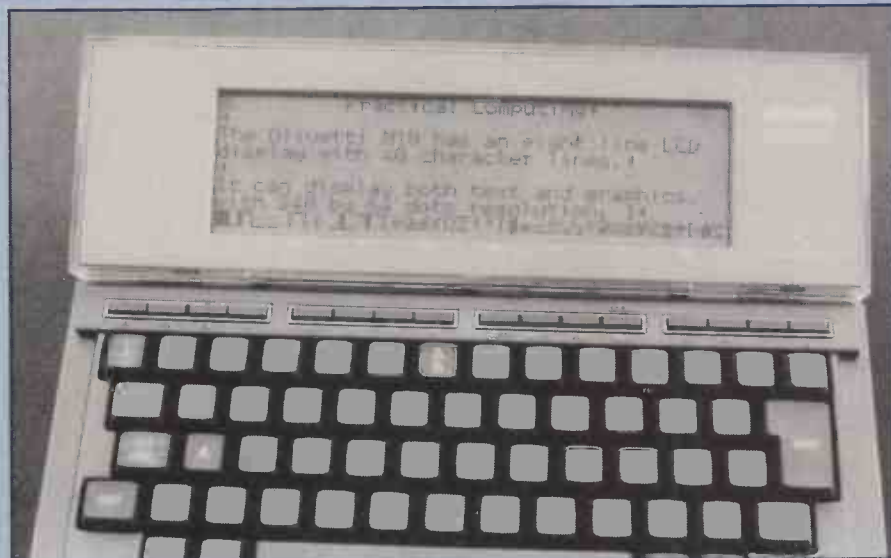

The Kyocera-built portables are light and cheap, but the display is restrictive.

processors such as Travelling Writer from Microtime International, and M-10/Word from Olivetti. Most of the Microtime packages run on all three Kyocera-made machines.

If you use your portable to send electronic mail or telexes via, say, Telecom Gold, the lack of formatting facilities is unimportant. Electronic mail is sent as a stream of ASCII characters, and the shorter the better. Formal letter layouts are not required; in fact they are a distinct disadvantage.

If your writing has a rigid structure, a portable can be used even for long texts. For example, I wrote a 5,000-word glossary for a book quite easily on an Olivetti M-10. The entries were in alphabetical order, so they were easy to find, and almost every definition was less than a screenful of text. Moving from section to section using Find was particularly easy. Of course, writing a 5,000-word feature would be a completely different matter.

There are now a number of portable micros on the market which provide virtually the same facilities as a desk-top model, and may indeed be software compatible. Examples include Data General's One and Toshiba's T-1100, both of which emulate the IBM PC, albeit using a 3.5in. disc instead of the standard 5.25in. size. The advantage of these machines is that they have a full-size screen which displays 80 characters by 24 or 25 lines. This means standard software can be run with little or no modification, which makes a powerful program such as WordStar the obvious choice for word processing.

Thus word processing on the move can be achieved without sacrificing any of the main facilities of word processing in the office. However, there are three major disadvantages. First, LCD technology is simply not up to the task of providing a legible 80 by 25 screen. Even the Data General screen, which is divided into four

sections to speed up the display, is practically unusable for word processing in all but the best lighting conditions.

Second, the more powerful portables are inevitably much heavier at around 10lb. instead of around 4lb. While they are certainly small enough to fit into a briefcase, they are much too heavy to carry around all the time. In my experience even the lightweight portables like the Kyocera models can become a burden if you have other things to carry, and anything that discourages you from taking the machine along somewhere defeats the purpose of the exercise.

Expensive peripheral

Third, the full-screen portables are too expensive for most people to buy as a second machine. Yet the limitations of LCD technology mean they are simply not good enough for use as the sole or main machine. Prices are in the £2,000 to £3,000 range, instead of £300 to £500, which is a lot of money for what is essentially a peripheral.

The other major competitor in the marketplace, the Epson PX-8, suffers from the same problems only less so. In size, weight and price it comes between machines like the Tandy 100 and the One. Although it lacks a full-size screen, offering 80 characters by eight lines, its major advantage is that it runs WordStar. The problem with WordStar on the PX-8

Text entry and Email are two useful applications.

is that like its brethren on larger machines it insists on keeping .Bak, or backup, files of everything, and this unnecessary duplication of files rapidly fills the available RAM store.

If you are looking for a machine just to use for word processing on the move, the PX-8 therefore offers no great advantages over the cheaper machines for its extra weight and cost. However, the PX-8 is certainly more sophisticated and more powerful, and if other tasks have to be done as well, such as running a small accounts program, spreadsheet or vertical-market package, it does offer real advantages.

Most computer manufacturers see a large potential market for portable micros, both for word processing and other simple tasks. Insurance agents, teachers, journalists, scientists and engineers, programmers and practically every type of salesperson are reckoned to be potential purchasers. However, the technology still has some way to go, particularly from the point of view of producing more legible screens. There must also be further attempts to reduce the size and weight of these machines.

Certainly it should be possible to make portable micros that are lighter and thinner than they are today. However, the major constraint on size is the keyboard, which has to be close to normal typewriter size if you want to type on it. Thus from a practical point of view, machines like the forthcoming Tandy 200 and NEC 8401a Starlet represent close to optimum facilities for word processing on the move, and even then the advantages over existing models like the Tandy 100, Olivetti M-10 and NEC 8201a are at best marginal.

Therefore it would seem that the next breakthrough will come when the keyboard can be dispensed with — and that means voice entry. Voice recognition and other artificial intelligence projects are under way with the aim of producing speech-to-text software. There are mighty difficulties, and a portable solution looks at least a decade away.

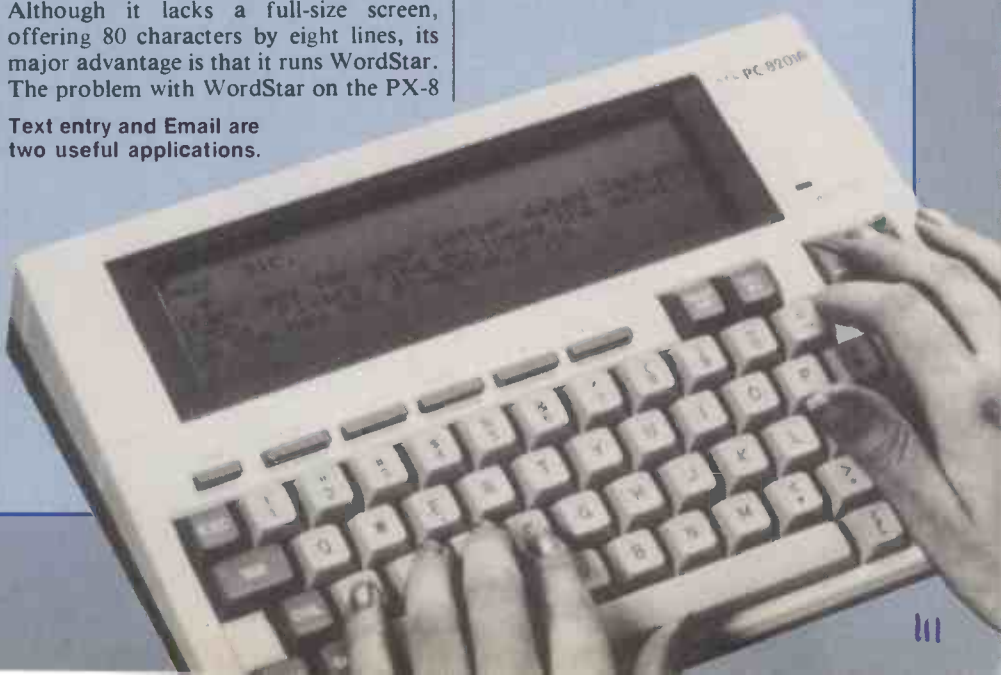

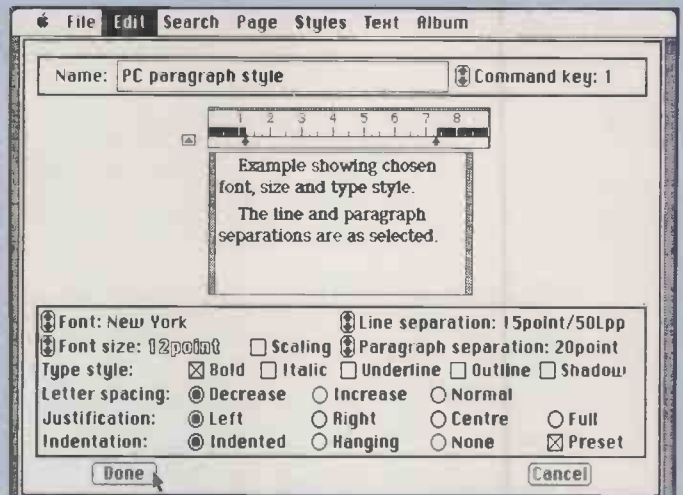
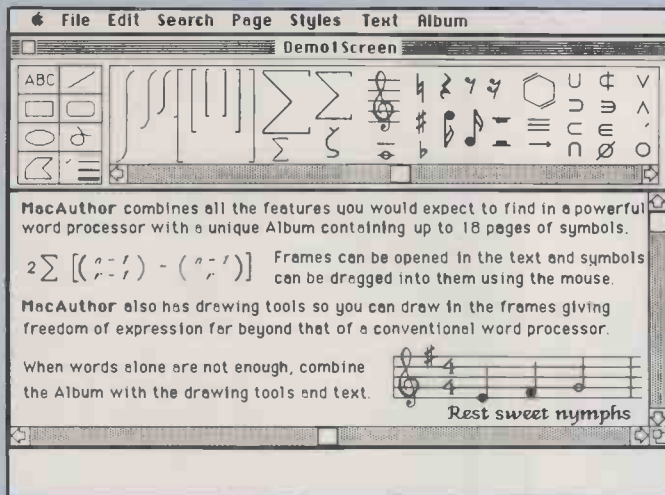

ON ANY OTHER machine Macwrite would be regarded as an outstanding program. It is easy to use and it is powerful. It lets you use a large number of different founts in sizes up to 24 point and even lets you incorporate pictures in your documents. What it shows you on the screen is almost exactly what it prints. Most important of all, both Macwrite and its picture-drawing companion Macpaint are included in the Macintosh system price.

But Macwrite does have some limitations, and as a result several companies are bringing out rival word processors. The most innovative of them is probably Macauthor, which is scheduled to go on sale in April. We have been looking at an early pre-release version, which although incomplete has given us a good idea of the distinctive features of the package.

Macauthor is intended mainly for people who want to produce attractive newsletters, reports and documentation. The intended users include businesses, university researchers and individual authors. Macauthor offers a great deal of control over the appearance of the finished output, which in many cases ends up being photocopied or printed at the local instant-print shop.

Like Macwrite, Macauthor is a WYSIWYG word processor. The Macintosh can easily display a whole range of print effects on its high-resolution screen; what is different about Macauthor is how you control them.

The key feature of Macauthor is the styles editor. It lets you define on-screen up to 18 different headings, paragraph and highlight styles. For instance, you could define your first heading style as 18 point Athens bold, centred, condensed and underlined, while your first paragraph style could be 12 point Geneva justified. Having defined these two styles you can then associate a command key with each one.

Styles are the equivalent of Macwrite's rulers but they allow much more control. They are also much quicker to use when you are editing a document. In Macwrite if you have several different styles of text within a document you have to copy a

Macintosh alternatives

Apple supplies the Macwrite word processor with every Mac it sells, so competing products start at a disadvantage. Ian Stobie looks at what's on offer.

ruler to the beginning of each passage of text. With Macauthor you just position the text cursor anywhere within the paragraph, heading or even word that you want restyled, and hit the appropriate control key.

The other advantage of the styles approach compared to rulers is that a single change to a style definition changes every occurrence of text in that style throughout the document. For instance, to change all centred headings to justified left in Macwrite would mean changing the rulers for every heading; in Macauthor

you have just to change one style sheet.

The styles editor gives you control over justification, tab and margin settings, fount, fount size, and fount style — that is, bold, italic, underline, shadow or outline. You can also condense or extend a type fount and alter the separation between lines and paragraphs. Adjustments to vertical spacing are made in increments of 1/72in., which is the unit used by most printers.

The styles editor does not just control the style of paragraphs and headings; it also gives you several options for high-

Macauthor specification

Document length: maximum 698 pages depending on disc capacity

Multiple-document processing: up to four documents may be open at a time, information is transferred between them with Cut, Copy and Paste commands

Founts: all Mac founts supported in normal, bold, italic, underline, outline and shadow; founts can also be used condensed, expanded and as superscript or subscript; two additional founts, Warwick Scientific and Greek are supplied with package; compatible third-party founts are already on the market for Macwrite

Styles: styles menu holds standard formats for paragraphs, headings and highlights; you can change fount, fount style, fount size, margins, justification, tab settings, line and paragraph separation

Album: contains up to 18 pages of small pictures or symbols up to 1in. square which can be dragged from album window into documents; larger images can be transferred via the clipboard from Macpaint documents

Tables: displays numeric data in columns, optionally lined up on decimal point

Hardware requirements: 128K or 512K Macintosh and Imagewriter-compatible printer; hard discs, separate numeric keypad and Apple laser printer also supported

Price: around £170

Availability: scheduled for April

Author: Icon Technology Ltd, 9 Jarrod Street, Leicester LE2 7DH. Telephone: (0533) 546225

U.K. distribution: Probe International, 78 Victoria Road, Widnes, Cheshire WA8 7RA. Telephone: 051-423 6666

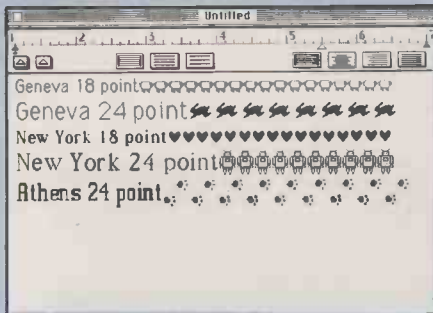

Macauthor and Macwrite allow you to try out a variety of different layouts, experimenting with type sizes and fonts, then give the best one to a typesetter if you still want to get work done professionally but do not know typesetter's jargon.

lighting individual words. Again, these are all invoked with a single control key while you are actually typing in or altering your document. All user-defined style definitions are automatically added to a styles menu. This means you have the option of selecting them from a pull-down menu in the usual Macintosh fashion instead of hitting a control key.

Macauthor also deals with pictures in a more flexible way than Macwrite. The bundled Apple word processor does not allow you to have pictures and text on the same line but with Macauthor you can. The procedure is to first click on Make Frame in the page menu and then drag diagonally with the mouse. This opens up a rectangular frame in the text and the words already there automatically move out of the way to accommodate it. You can then either leave the frame empty or copy a picture into it from the clipboard. Frames can be of any size up to the page size, which is itself user-definable.

Leaving a frame empty is something you might want to do if you are taking your Macauthor output down to a printer, who can paste artwork or correctly screened photographs into the gaps. If you are not doing this then you can get images you have drawn yourself from Macpaint. Also you can use an image taken from one of

Macwrite: problems and plusses

Macwrite severely limits document size because it holds the document which you are currently editing entirely in memory. On the 128K Mac you can typically get no more than nine or 10 pages of single-spaced A4 text in a document, and the figure is even lower if you have incorporated several pictures. On the 512K Fat Mac the situation is better and 40-page documents are possible. None of the rival word processors coming out for the Mac suffer from this problem as they split long documents between disc and RAM.

However, Apple has already developed a new, disc-orientated version of Macwrite which allows much larger documents. It will probably be released in the U.K. sometime in April. Apple U.K. assures us that existing Macintosh owners will be able to get the upgrade from their dealers for a nominal sum.

There is a little-known but very simple way of generating graphics symbols for inclusion in Macwrite or other word-processing documents. Each Mac font includes a variety of undocumented graphics characters which can be typed in directly from the keyboard. These were first described in the excellent American magazine *Macworld*, and are not mentioned in Apple documentation.

To see the graphics characters you need to press the Option, Shift and # keys at the same time. Having typed in a few characters try changing them to different font sizes: the graphics symbol may well change since each font has two or three associated with it at different sizes. These undocumented keyboard characters can also be used in Macpaint, where you can produce them bigger.

the many picture-library discs available from third-party suppliers such as Mac the Knife, Click Art, and da Vinci Buildings, Landscapes and Interiors.

Macauthor provides an additional and very convenient way of dealing with small pictures less than 1in. square. Macauthor's own internal library for frequently used symbols, known as the album, can be up to 18 pages long. The library editor works like Macpaint's Fat-bits and lets you draw very detailed small shapes.

To get symbols from the album you first click on a pull-down menu to bring up the album window, which takes up about the top third of the screen. A scroll bar lets you flip through the album to the relevant page. Then, as you continue editing your document, you use the mouse to drag

down copies of the symbols from the album as required, and position them in your text. At the left of the album window is a set of eight drawing tools similar to the larger set contained in Macpaint. You can use them to draw in any frame you have opened in your text.

Normal text editing works much like Macwrite. Since we had a very early pre-release version of the product to look at, it was not possible to form any valid impression of how fast the release version of Macauthor will be. One crucial difference in the way a copy typist and an author use a word processor is in the number of modifications made: the author is likely to make many more. This can slow down many word processors and is a good thing to test if you intend buying a word processor for writing. 

Other word-processing options

Microsoft Word was announced some time ago for the Mac and has been severely delayed. But we are pleased to say it does definitely now exist, and we received a copy as we went to press. From a quick look it seems likely to appeal most to business users as it is strong on traditional secretarial word-processing tasks. Word was first released for the IBM PC towards the end of 1983.

Word is a WYSIWYG word processor like Macwrite, with multiple fonts displayed on screen; it also lets you have several documents open at the same time. For Mac users most of this is familiar territory, but for IBM users the multiple fonts, the windows, along with an optional mouse interface, probably still make Word a great step forward. Possibly the most appealing thing Word brings to the Macintosh user, and which might justify the expenditure of £190, is comprehensive mail-

merging and boilerplating facilities.

Main Street Writer appears in Apple's *Mac Buyers' Guide* but as far as we know is not yet available. From published details it appears to be a fairly simple package offering little more than Macwrite, apart from the ability to handle large documents and have several of them on screen at the same time.

Two other Mac products with a word-processing element are Jazz and Thinktank 512. If things go according to Lotus Development's plan Jazz goes on sale in April. It is a multi-function calc/WP/graphics/database/comms product similar to Symphony.

Thinktank 512 is more an ideas organiser than a word processor. You start by typing in headings and sub-headings, and then hide text behind them. You can then print either the entire document, or selectively print text at whatever heading level you specify.

MICRO·SIGHT

IMAGE ANALYSIS SYSTEMS FOR MICROCOMPUTERS



MICROSIGHT I

An image scanning system which enables video images to be captured and stored in a micro-computer's RAM at a resolution up to 256 x 256 with 255 grey levels. Complete with camera and interface, MicroSight I will store images on disk or output them to a printer.

MICROSCALE II

An image analysis package which enables the user to define windows in the image and derive areas, perimeters, particle counts and size distribution.

MICROSIGHT IIR

A framestore based image acquisition system which can capture a 512 x 512 video picture at 64 grey levels. Complete with camera interface and video output MicroSight IIR can be driven using subroutines supplied.

MICROSCALE IIR

An image analysis package which enables a microcomputer to derive information from a 512 x 512 video frame. Facilities such as enhancing, subtracting and averaging are included with optional pseudo colour output.

Systems available for IBM PC/AT, Victor 9000/Sirius, Apricot, Hewlett Packard 9816, BBC Apple, Etc.

DIGITHURST

Digithurst Ltd.,

Leaden Hill, Orwell, Royston, Herts., SG8 5QH

TEL: CAMBRIDGE (0223) 208926

The Great British Laboratory Micro System!



The CED 1401, real time heart of professional laboratory systems

High performance hardware
and

Full laboratory software – including FFTs – is standard

Demonstration programs include Spectrum Analyser, Signal Averager

The 1401 is made in Cambridge, England—and runs just as fast with Apples and IBMs too!

CED

Real-time Computers

Tel: Cambridge (0223) 316186

Science Park,
Milton Road,
Cambridge,
CB4 4BH

● Circle No. 125

NEW
from

QUME



NOW! Ex. stock
delivery through most
Major Dealers

"No Compromise" – with the Sprint 12/20 letter Quality Printer from the World's leaders in word-processing printers

A good speed for business and professional use,

Engineered by Qume for superb print quality and reliability for years of every day use

– and the price is right

Other important features –

1. Interface compatibility with most popular desktop computers i.e. Serial, Centronics Parallel or Qume Sprint 3

2. Compact design – user friendly

3. The widest range of easily interchangeable typefaces in the industry

4. Uses Qume standard Printwheels and Ribbons the most accessible range available

Accessories include –

Optional Forms Tractor and Letter Guide

Backed by Qume's proven World-Wide Sales and Service organisation

Qume[®]

Qume (UK) Limited,
Edgewater Close, Reading, Berkshire RG3 1JT.
Tel: Reading (0734) 584646. Telex: 849706

A British Company of **ITT**

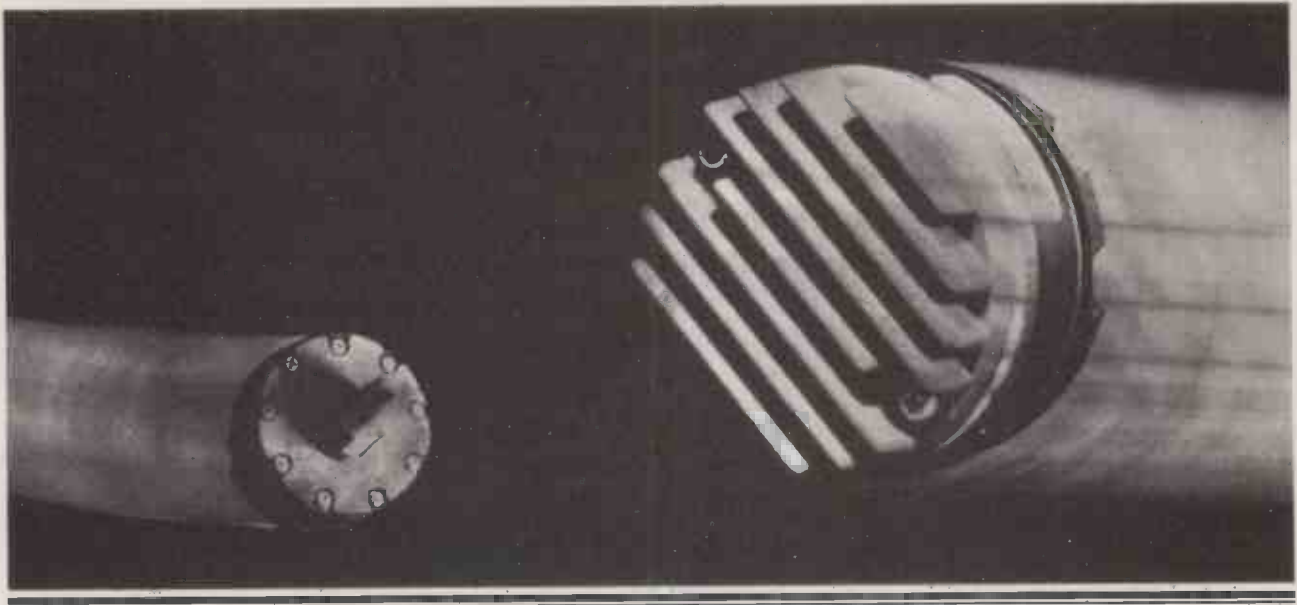

EITHER AN OKI OR HEADS WILL ROLL.

OKI IS O.K.

Imagine a head that can print 500 million characters – 1/4 million A4 pages – without falling over. Imagine an OKI 2410.

500 million characters of needle sharp quality – the OKI 2410 is the No. 1 professional standard for heavy duty applications.

It's the clearest proof of the superiority of OKI performance. Performance based on high quality and reliability, so that while other printers are falling down, OKI printers continue to give you print perfection. Perfection built in by OKI's robotic production assembly line. The robots themselves are OKI designers and characterise the futuristic thinking of the com-



X-DATA Ltd. · 750/751 Deal Avenue
Slough Trading Estate Berks SL1 4SH
Tel. Slough, (0753) 72331 · Tlx. 847728

pany. All OKI printers, including the best selling MICROLINE range, are designed and built the same way, ensuring that from the least expensive to the top of the range, OKI quality and reliability is constant throughout.

Don't forget, no-one's head has ever rolled for buying OKI printers . . .

So now that you'd like to know more about the OKI printer range, contact us at the address below and we'll send you the information you need. Better still, why not see an OKI printer in the flesh. Call in and see your local approved dealer now – otherwise heads will roll . . .

Black Hole

Uncertainty and bluff are two crucial elements of this chess variant. David Levy proposes an algorithm capable of handling them both.

A READER once wrote to me with a suggestion for a new variation on chess. I have always found the classic game itself to be sufficiently absorbing and those variations which I have encountered did not appeal to me. Examples include Loser's Chess, which consists of trying to give away all of your own pieces; Cylindrical Chess, in which you play on a wrap-around board; and Hexagonal chess. But as I read and reread the letter suggesting Black Hole Chess, I realised that here was a variation which offered two new dimensions, uncertainty and bluff, combined in a fascinating way.

Difficult to master

The idea is simple, but to play the game well is a more difficult task than mastering chess itself. At the start of the game each player writes down the location of any one of the 64 squares of the chessboard, but does not declare it to his opponent. This square is his own Black Hole. If at any time a player makes a move on to or over his opponent's Black Hole, that piece disappears into oblivion. The opponent reveals the location of the Black Hole and removes the offending piece from the board.

For example, from the position in figure 1 White might play his bishop from f1 to c4. Unknown to him the opposing Black Hole is on d3, so his opponent reveals the piece of paper and takes the bishop off the board since it crossed the d3 square on its path from f1 to c4. The player of the black pieces now writes down another square location — it can be the same one — and this becomes his new Black Hole. In this situation a cunning player might decide that f1 is the new Black Hole, so if White tries to castle king's side he loses his king and the game because the king falls into f1 as it tries to pass over that square.

The game of chess is transformed. You can no longer analyse with certainty, since a sequence of moves which appears to win by force may result in the loss of a key piece. Furthermore, there is a big element of bluff.

In figure 2, White has just moved his rook to e1, attacking the black queen on e7. If nothing is done to parry the attack, White's next move could be to capture the queen with the rook. But if one of the squares e2, e3, e4, etc. turns out to be the opponent's Black Hole then White plays Re1xe7 his opponent will turn over the piece of paper with say, e6 written on it, and take the white rook off the board.

But the problem is not so simple. Sup-

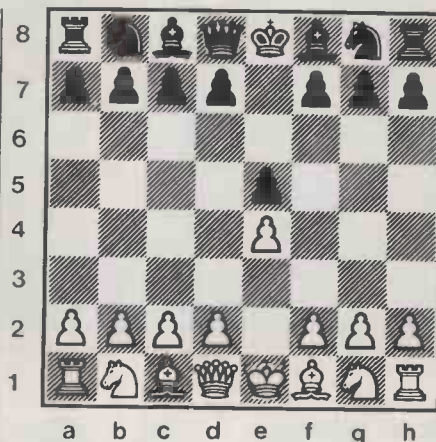

Figure 1.

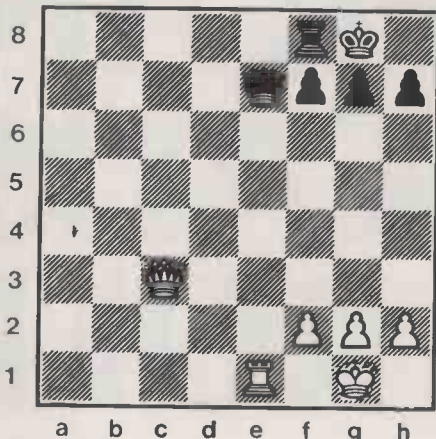

Figure 2.

pose the player of the black pieces makes a move which does nothing about the attack on his queen. What is White to think? One possibility is that Black has overlooked the fact that White can take his queen with the White rook. Alternatively, White might conclude that Black is bluffing: he would never allow his queen to be captured for nothing, so he must have put his Black Hole somewhere along the file from e2 to e7.

It is such areas of uncertainty that make Black Hole Chess so interesting. If you do not feel sufficiently confident to try writing a strong chess-playing program, this is a game which offers scope for your programming talents on virgin ground. The chess heuristics need not be as sophisticated as those employed in a chess program, but the task is still just as challenging.

Consider how this game might be programmed using only a one-ply search, that is without any look ahead. You will need to employ an evaluation function for chess. Use the swap-off algorithm so that

your program can determine, without look ahead, whether or not a particular piece may move to a particular square safely.

Next consider the probability, for each square on the board not occupied by one of the program's own pieces, that the square is the opponent's Black Hole. Denote the probabilities as $P(a1)$, $P(a2)$, $P(a3)$, etc., where $P(a1)$ is the probability that the square a1 is the opponent's Black Hole.

Score for each move

The program can determine a value for each move by multiplying the score for the resulting position as determined by the evaluation function, by the probability that the move will not result in the moving piece falling into the Black Hole. In the previous example, the value for White of the move Re1xe7 would be

$$[\text{approximately 9 pawns}] \times [1 - P(e2)] \times [1 - P(e3)] \times \dots \times [1 - P(e7)]$$

For the sake of simplicity refer to the product

$$[1 - P(e2)] \times \dots \times [1 - P(e7)]$$

as the probability that the move Re1xe7 is playable, abbreviated to $P[\text{Re1xe7}]$.

The method will work fine when there is no look ahead, and dealing with a tree search is not very much more complicated. In figure 3 the program must choose in the root position between move M1 and move M2. In reply to M1 the user may play only M11 or M12. There may be other pseudo-legal moves which would require the moving piece to move across or land on the program's Black Hole, but such moves may be ignored. If the user replies to M1 with M11, the program has the choice of M111 and M112. If this is the full extent of the search process, and evaluation takes place after three ply, the program computes a value for the terminal positions of

$$[\text{apparent score for position}] \times$$

$$[\text{probability of being able to reach position}]$$

where the probability of being able to reach the terminal positions are

$$P[M1] \times P[M111], P[M1] \times P[M112], P[M1] \times P[M121], P[M1] \times P[M122], \dots P[M2] \times P[M222]$$

In the case of the user's moves you always know whether or not the move is playable, but in the case of the program's own moves you must make a probabilistic estimate.

This method of determining the prob-

Figure 3. Simple three-ply decision tree, starting with the program's own move. Moves by the user which cross the program's Black Hole may be ignored.

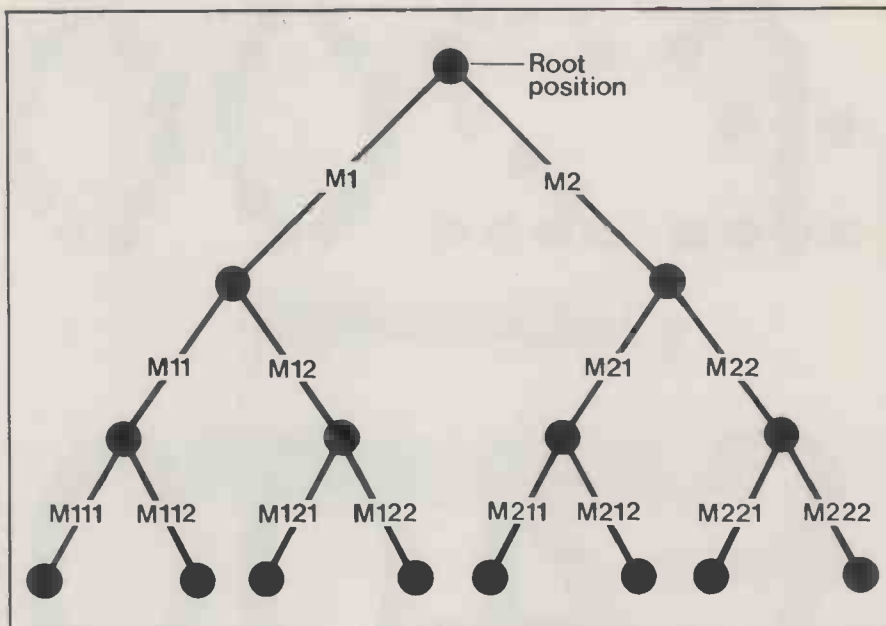

ability of being able to reach a terminal position is only an approximation. To be as accurate as possible you will need to update your probability arrays after every one of the program's own moves in the game tree. For example, if the move M1 is Re1xe7 and this move turns out to be possible, the program knows that none of the squares e2, e3, . . . e7 can be the user's Black Hole. Therefore, P(e2), P(e3), P(e4), . . . P(e7), should all be set to zero. The other, non-zero, probabilities may now be normalised for those parts of the tree occurring after the move M1. This process will provide more accurate probability measures for when the program needs to calculate the probabilities P(M111), P(M112), P(M121) and P(M122).

Probability estimates

Determining the probability estimates for the various squares is not easy, and here the element of bluff must be considered. At the start of the game the program must assign estimates to each square not occupied by one of its own pieces, so if the program is White it must consider all of the squares on ranks 3 to 8 inclusive. It is reasonable to assume that the Black Hole is more likely to be on a central file rather than an edge file and that it is more likely to be on the king's wing, where castling is most likely to take place, than on the queen's wing. These estimates must add up to 1, so the final few instructions in your probability-estimation routine should normalise the probability estimates.

As the game progresses, the program can update the estimates by making use of information gleaned from its own moves. For example, if the program is White and opens with the move e2-e4, and if the user fails to remove that pawn, the program knows that neither e3 nor e4 is the user's Black Hole. It can then set P(e3) and P(e4) to 0, and normalise each of the other non-zero probability estimates. If the user responds e7-e5 and the program then plays Bf1-c4 without its bishop falling into the void, the program knows that neither d3 nor c4 can be the user's Black Hole, and so on.

As the program builds up information about which squares cannot be the user's Black Hole, so it will be able to make better use of its pieces by moving them across and on to squares that are known to be safe. In fact, if you update the probability estimates after every one of the program's own moves in the tree search,

your program will sometimes make a move just to see if a particular square is safe for a more valuable piece.

The strategy your program employs to decide how to locate its own Black Hole should not be too rigid, or the user will be able to take advantage of its inflexibility. The program should determine a measure of importance for each possible square, and then choose in some random manner between, say, the eight most important squares. The importance measure could be the number of ways each square can be crossed over or moved to by the user's pieces. So in the initial position, the square a6 would have an importance count of 3 from White's viewpoint — pawn from a7 to a6, pawn from a7 to a5 across a6, and knight from b8 to a6.

Placing a Black Hole

When a new Black Hole needs to be nominated the method of assigning importance measures to each square can be made more sophisticated. For example, a tree-searching program that used the killer heuristic could perform a search from the root position on the assumption that it had not nominated any square as the Black Hole. The program could then keep track of which of the user's moves appeared most often as killers in the tree search. This information could be used to determine which squares were the most important: that is, those squares landed on or crossed over during the course of making the killer moves. The program would then be assigning importance in such a way as to make it difficult for the user to make what would otherwise be his strongest moves.

This strategy has some obvious applications, particularly in the endgame, but as the number of enemy pieces on the board is reduced, the frequency with which the program can nominate new Black Holes is also reduced. So in the end-

game the program needs to think very carefully about which squares might be the best Black Holes. One obvious heuristic is that if the user has only one passed pawn, or only one pawn which might become a passed pawn, the program might well nominate as a Black Hole one of the squares over which this pawn must pass in order to reach its promotion square.

Blunder or bluff?

Finally, consider the element of bluff. How should the program assess whether the user has made a gross blunder, allowing the capture of his queen, or whether there is a Black Hole somewhere along the path? At the start of a game or playing session, the program should begin with an estimate of how likely it is that the user will bluff. This bluff factor can be randomly set between 0.5 and 0.1.

If the user makes a move which appears to leave a piece en prise, the program multiplies each of the probabilities on the capture path by the bluff factor before calculating its move. If it decides to call the user's bluff and it turns out that the user was indeed bluffing, or if it decides not to call the bluff but later discovers that the user was bluffing, then the bluff factor can be increased — multiply by 1.5 up to a maximum of 0.9. If the program discovers that the user was not bluffing, the bluff factor can be halved. This technique allows the program to adapt itself to the user's own bluffing style.

The Black Hole concept may be adapted to almost any other board game you wish. If you want to add yet another dimension you could change the rules so that the existence of a Black Hole did not automatically cause the capture of an enemy piece which crossed over or landed on the deadly square, but only did so at the discretion of the player controlling the Black Hole — though this is perhaps an unnecessary complication. 

£200



£400 *

Twice the price.
10 times the quality.

You'd expect to pay around £200 for a dot matrix printer – fine for printing documents meant for internal consumption, but not so hot when writing to customers, suppliers, prospects – anyone you want to impress.

Yet for an extra £200 or so, your printout can look – quite simply – superb. The picture shows unretouched examples of a dot matrix printout and a printout from Triumph Adler's new daisywheel printer, the TRD 7020. (Both magnified 16 times.)

The difference speaks for itself: ten times the quality, at only twice the price.

The 7020 is no snail, either. At 20 characters per second (that's just 40 seconds to print this lot), its speed/quality/price ratio is second to none. It's simple to use, too. Just what you'd expect from a company that makes and sells more typewriters than almost anyone else in the world.

So the choice is yours. Cheap and nasty? Or a little bit more for the real thing?

Get in touch with Triumph Adler now for details on the TRD 7020 and the name and address of your local dealer.

TA TRIUMPH ADLER
Printer Division
Jordan House 47 Brunswick Place
LONDON N1 6EG Tel: (01) 253 5608

* £375 plus VAT

● Circle No. 134

dBASE
Training
Programming
Software

LANTECH
Information Systems

55 Peascod Street,
Windsor, Berks.,
Tel: Windsor
58182/58013

● Circle No. 187

SWAP MICRO TO MICRO
FILE TRANSFER
SYSTEM

"Get your microcomputers talking to each other!"

SWAP allows you to transfer any programs and data between 2 computers of different manufacture. SWAP consists of 2 floppy disks and a cable configured for your 2 chosen computers. Here are some of the formats available:

IBM PC	IBM Compatibles	Sirius
Apricot	Apple (CP/M)	HP150
Televideo	Superbrain	BBC
Sanyo 555	DEC Rainbow	Kaypro

If your format is not in our extensive range we can usually produce it at little or no extra cost.

The price of SWAP is £158 (£135 plus VAT and postage and packing). Please specify your computers when ordering.

MERCATOR COMPUTER SYSTEMS LTD
3 Whiteladies Road, Clifton, Bristol BS8 1NU.
Telephone: (0272) 731079
Telex 44220 Comtel Ref 247

MERCATOR
COMPUTER SYSTEMS

● Circle No. 132

DON'T DEAL WITH THE REST, DEAL WITH THE BEST
 **The market leaders!...**

PARTICIPATE IN OUR SUCCESS!
 Become an ATA franchise
 Ring (0727) 34361 NOW
 and speak to Charmian Rowley!

apricot

Apricot F1e 128k RAM single 315k Disk Drive.....	848.00
Apricot F1 256k RAM single 720k Disk Drive.....	985.00
Apricot PC 256k RAM single 315k Disk Drive.....	1150.00
Apricot X15 256k RAM 5mb S/S Drive.....	1999.00
Apricot X110 256k RAM 10mb D/S Drive.....	2299.00
Apricot Monitor.....	170.00

The complete range of Apricot computers and Apricot software is available. Please phone for details.

PRINTERS AND PLOTTERS

Epson RX80.....	249.00
Epson RX80F/T.....	289.00
Epson RX100.....	415.00
Epson FX80.....	360.00
Epson FX100.....	499.00
Epson H180 Plotter.....	349.00
Centronics Horizon H80.....	375.00
HP ThinkJet Printer.....	375.00
HP LaserJet Printer.....	3195.00
HP 7470A RS232 or HP 1B A4 Plotter.....	985.00
HP 7475A RS232 or HP 1B A4 Plotter.....	1549.00



HEWLETT PACKARD PERSONAL COMPUTERS

We have a selection of Hewlett Packard demonstration hardware and software for sale at enormous discounts. Please ring for details.

Macintosh

Macintosh 128k computer.....	1499.00
Macintosh 512k computer.....	2149.00
External Drive.....	299.00
10" Imagewriter with accs. kit.....	355.00

Macintosh

FileVision.....	134.00
Multiplan.....	141.00
Chart.....	110.00
Word.....	119.00
File.....	119.00

Full range of Macintosh Software available.



Apple IIC 128k RAM 80 col.....	765.00
Apple IIe 64k Computer.....	449.00
Apple III 256k Computer.....	1690.00

IBM ACCESSORIES

Hercules Graphics Card.....	355.00
Hercules Colour Card.....	178.00
Sigma Maximiser Multifunction Card.....	266.00
The NEW Quadboard.....	295.00
PC Express Accelerator Card.....	626.00
64k memory upgrade (9 chips).....	49.00
E/Buffer Printer Buffer.....	from 58.00
Torus Icon Local Area Network.....	POA

BUYING AN IBM PC THEN FIRST CONSULT



IBM PC AUTHORISED DEALER*



FOLLOWING ALBETA'S SUCCESSFUL TAKEOVER OF ATA WE WILL CONTINUE TO OFFER THE BEST VALUE FOR MONEY COMPUTER PRODUCTS, INCLUDING THE IBM PC AND ALL IBM SOFTWARE

IBM PC SYSTEMS

IBM PC Business Starter System:	
IBM PC 128k RAM, 2 disk, monitor, keyboard.....	1675.00
IBM wordprocessor, spreadsheet, filing s/ware.....	270.00
IBM PC Office System:	
IBM PC 128k RAM, internal 10mb hard disk, 360k disk, DOS 2.1, monitor, keyboard.....	2295.00
Wordstar, Multiplan, DMS+.....	549.00

IBM PC XT Executive System:	
IBM PC XT 256k RAM, 10mb hard disk, 360k disk, DOS 2.1, monitor, keyboard.....	2895.00
Multimate, dBase III, Lotus 1-2-3.....	1049.00
Accounting System:	
Pegasus (Sales, Purchase, Nominal, Invoicing Stock, etc.).....	per module 180.00

Terms and Conditions upon application.
 30 days credit available for official orders from plc's and public sector organisations subject to 5% credit charge. Please phone for details.



PRICES EXCLUSIVE OF VAT AND CURRENT AT TIME OF PRINTING.



ATA IS A DIVISION OF ALBETA

LONDON 4 Albion House, 1 Back Hill, EC1	01-833 0044
*ST. ALBANS 9 Adelaide Street, St. Albans	(0727) 34361
SHEFFIELD 72 Eldon St, Sheffield S1 4GT	(0742) 700802
POTTERS BAR 197 High St, Potters Bar	(0707) 57113
SOUTH WEST Cwrt-y-Gaer, Wolvesnewton	(02915) 700
NORTH WEST 32 Greenfield Ave, Parbold, Wigan, Lancs	(02576) 3113
TELEX 946240 CWEASY G (Please quote REF: 19003030)	

Please telephone for the latest price list

● Circle No. 165



A chip off

The chip, of course, is the 8088 as used in the IBM[®]PC. The operating system is customised to MS[™]-DOS compatibility. The user memory is 256K RAM, that's four times as much as big brother. The floppy disc storage is 720 Kbytes, that's more than

double the basic PC. We've only got two expansion slots, but there again we use them for expansion and don't need to tie them up with basics such as colour graphics or printer ports.

We are disc compatible to Lotus 1-2-3 and most other popular business

software. And hardware compatible, accepting auto-dial/auto-answer internally housed modems, networking and memory expansion cards, plotters and just about any board level product developed for the IBM[®]PC.

And at under £1200, including VAT and a suite of

the old block.

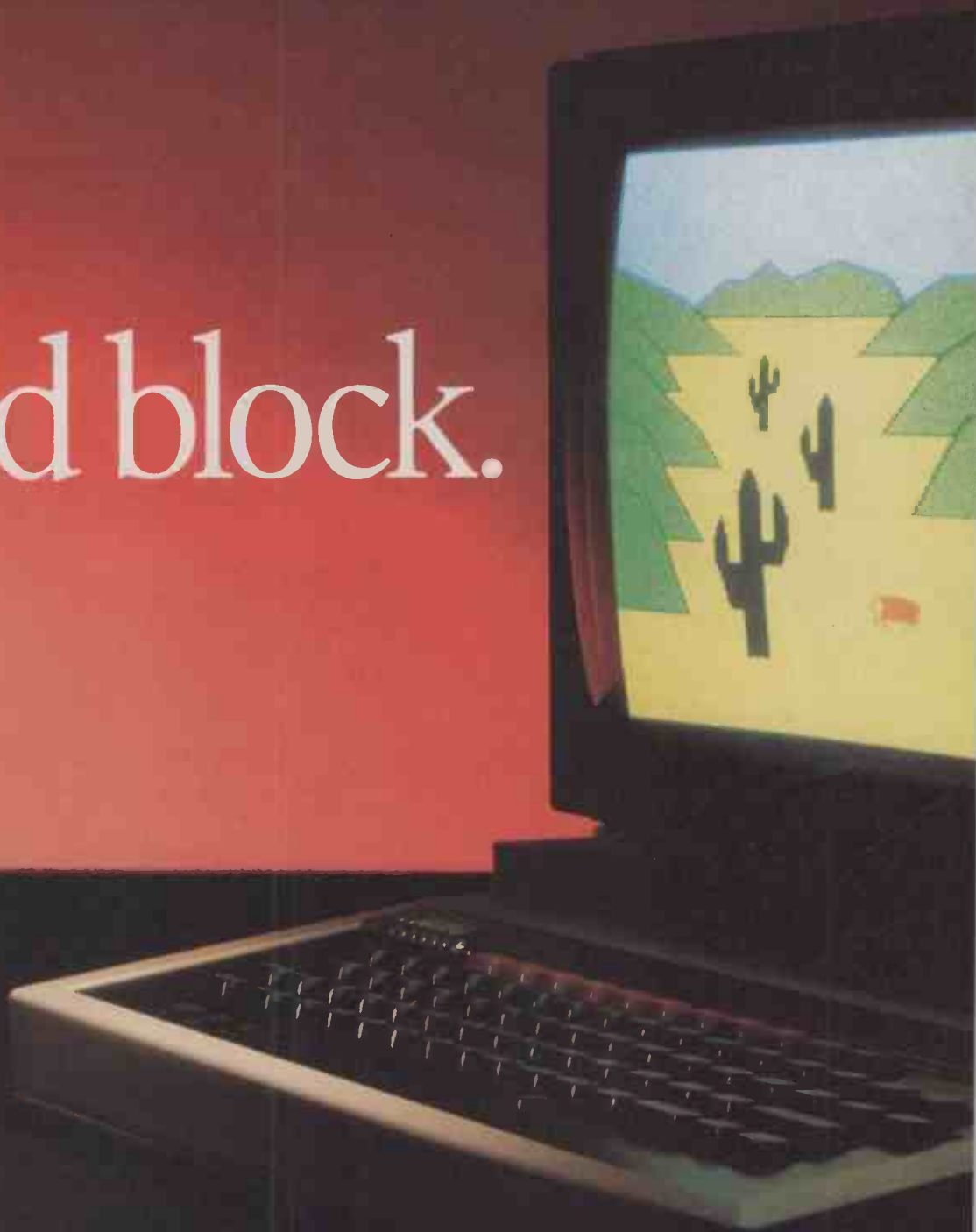
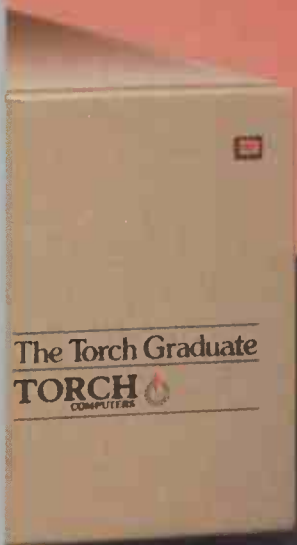

PSION XCHANGE business software to get you started, we're less than half the price.

Isn't it a shame we're only available to BBC Model B Micro owners.

Torch Computers, dedicated to the BBC Micro in more ways than one.

For the name of your local Torch Graduate dealer complete the reader enquiry card or ring (0223) 841000.

Torch Computers Ltd., Abberley House, Great Shelford, Cambridge CB2 5LQ.

Torch Graduate
TORCH
COMPUTERS

Technical Specification • 8088 16-bit CPU (5Mhz) • 256K RAM • MS™-DOS operating system customised to IBM PC compatibility • Twin double sided, 5 1/4" floppy disc drives (each 360K formatted) • 2 IBM PC compatible expansion slots • Free PSION XCHANGE software (Abacus, Easel, Archive, Quill) • Software compatibility allows Lotus 1-2-3 and popular IBM PC business programs to run without modification, subject to constraints of BBC keyboard and display • Acorn Disc interface is not required • Keyboard, text and graphics by BBC Model B Micro.

QUALITY NEVER LOOKED SO GOOD—

Now everyone with a BBC or IBM PC will want to get their paws on CUB's sleek new D series plastic cabinet — a triumph of ergonomics and up to the minute design. Within it is the CUB 653 MEDIUM RESOLUTION colour monitor — the perfect mate for computer users who wish to combine the advantages of brilliant, low cost colour graphics with 80 column processing software.

CUB 653's remarkable depth of colour is enhanced by minimal screen glare, thanks to a super high contrast CRT. Even in well lit environments the 653 (H) x 585 (V) resolution and 0.43mm dot pitch produces 80 column text which is pin-sharp and easy to read. Owners of SHARP, RML 480Z, APPLE Series, WANG and other leading computers needn't feel left out, because CUB 653's compatibility extends to these models and many more.



PICK ONE UP FOR JUST £299 inc. VAT

NEW LOW PRICE. NEW PLASTIC CABINET — THERE'S NEVER BEEN A BETTER TIME TO BUY.

Standard Resolution version also available in new cabinet. Both Standard and Medium resolution models produced in metal cabinets if required.



MICROVITEC 653
CUB
COLOUR DISPLAYS

Microvitec PLC, Futures Way, Bolling Road, Bradford, BD4 7TU, West Yorkshire
Tel: (0274) 390011 Telex: 517717

Available from High Street Computer Retailers and selected branches of W. H. Smith, Harrods, John Lewis Partnership, John Menzies with selected models available from larger branches of Boots.



>OPEN FILE

PRACTICAL COMPUTING

APRIL 1985

Open File monitors

Amstrad.....Ian Stobie
Apple.....Bill Hill
BBC.....Nicholas McCutcheon
Commodore.....Mike Todd
CP/M.....Jack Schofield
IBM PC.....Jack Schofield
Tandy.....John Wellsman
Research Machines.....Ian Stobie
Sharp.....John Hooper
Sinclair QL.....Glyn Moody

In Open File we offer programming tips and free software to key in — from demonstration routines to ready-to-use business programs. As well as major feature programs, every month we publish a selection of software written by our readers.

We welcome serious software for any of the micro systems listed above, especially short routines and utilities. Programs can be in machine code, Basic or any other language.

Submissions should include a brief description which explains what your program does, and how it does it. If possible it should be typed, with lines double-spaced. We need a printed program, which should be listed from a fully debugged, working program. Hand-written listings cannot be accepted. A tape or disc of the program helps if it is in a standard format.

When printing listings, please remember to use a new ribbon or double-intensity printing — faint listings reproduce badly. Use plain paper only, and try to list the program across either a 35-character or a 70-character width. Also, make sure all special graphics or inverse video characters are either listed correctly or else include Rem statements to explain them fully.

Each program listing, tape or disc must have your name and address on it, or we cannot promise its safe return. A stamped addressed envelope is appreciated.

If you write in with a comment, correction or enquiry please remember to state the machine and the program title.

We pay at least £10 for any programs used, or £35 per page and pro rata for part pages.

>FEATURES

126 MULTI-TASKING IN BBC BASIC
David Elworthy's kernel program allows you to implement several applications at once on a BBC Micro.

133 FILE LISTER
With John and Timothy Lee's SList utility you can read the contents of a CP/M file a screenful at a time.

142 INSIDE OS
Part 3 of Roger Cullis's series in which he dissects the BBC Micro's operating system.

>BBC

148 RISING PITCH
James Allwright's cunning program combines visual and audible illusions.

149 NORMAL PROBABILITY
C Dunne calculates probabilities and confidence limits based on a normal distribution and plots the results graphically.

150 ENGINEERING NOTATION
Des Fisher's routine takes any number and generates a string which expresses it in engineering notation.

150 SNOW SCENE
A wintry graphics demonstration program from P A Watmough.

>IBM PC

153 DATE CHECKER
A date-checker routine can take up valuable space, so James Garlick has written one which only requires a single line of code.

153 FUNCTION-KEY CONTROL
The display of function-key definitions which appears while Basic is running can be switched off by the Key Off command, but this leaves the function keys active. Mike Curtis provides a routine which clears the keys until Basic is reloaded.

153 PRINTING WITH WORDSTAR
How you can obtain double-width and compressed-print facilities on the IBM PC graphics printer using WordStar.

>AMSTRAD

157 BASIC SCREEN DUMP
Basic is too slow to be of much use for dumping the contents of the Amstrad screen to a printer, but F M Collins has sent in a fast machine-code program to enable you to do the job.

>COMMODORE

159 SAVING AND LOADING
Routines to allow you to save blocks of memory to disc or tape and to load them back from within a program.

159 HIGH-RESOLUTION SCREEN DUMP
A machine-code program by J R Jones that generates a bit-image representation of the screen, allowing you take advantage of the high-resolution graphics capability of the Commodore 64 and the Epson MX and FX printers.

160 REVERSE REMS AND RELOCATOR
Mike Hart offers a more robust version of the Reverse Rems program which appeared in Open File November 1984.

Send your contribution to:

Open File, Practical Computing,
Quadrant House, The Quadrant,
Sutton, Surrey SM2 5AS

Multi-tasking in BBC Basic

David Elworthy's kernel program allows you to run several applications at once on a BBC Micro.

A CPU can only do one thing at a time. True multi-tasking is therefore out of the question. But things move fast at processor level, so you can give the user what appears to be several programs running at the same time simply by making frequent switches back and forth from one task to another.

At its most effective, multi-tasking is implemented at operating-system level. However, it is also possible to implement multi-tasking from Basic, which is what this program does for the BBC Micro. It is not perfect: in particular, the programmer must indicate points where one program is allowed to switch to the next.

The programs or tasks may be entirely independent, or they may communicate with each other by having variables in common. A complete multi-tasking program will consist of three parts: the kernel of routines required to switch between tasks, the initialisation routines which create the test task, and the tasks themselves. Only the first two are standard, of course; the third item is the user's own program.

To write the multi-tasking kernel you must first have a means whereby an indicator can be set after a specified length of time. The individual tasks can then check this indicator to see if it is time to go on to the next task. You must also be able to save and restore pointers to where the next statement in each task is. Line numbers are not sufficient here, since you may have to switch to and from a task in the middle of a multiple-statement line.

The BBC Micro has several internal timers. One of them, the interval timer, can be set up to cause an event when its value reaches zero. An `Osword` call allows you to set it to any value. When the event occurs, normal processing of the Basic program is suspended, and the machine-code routine whose address is in locations `&220-1` is executed. Thus, if you make the routine specified by these addresses set an indicator, the first problem is solved.

The other problem is harder, and requires a little more knowledge than the manual provides. Basic at all times maintains a pointer which contains the address of the next statement to be executed. The

Listing 1.

```
1240REM*** MULTI TASKING KERNEL ***
1250REM
1260REM This sets up the machine code routines and the various parameters
1270REM used by them
1280REM At the start of the program, include the lines:
1290REM opt=2 (or 3 if listing required)
1300REM *FX13,5 (disable interval timer)
1310REM PROCKernel(...) to create kernel

1320REM
1330REM The parameters used by PROCKernel are:
1340REM slice%=time slice for each task
1350REM This value is placed into the lower 4 bytes of the interval timer;
1360REM thus &FFFFFFE gives slices of 2/100 seconds
1370REM tasks%=number of tasks to be included
1380REM This value must be exact!

1390REM
1400REM After PROCKernel has been called, each task must be created
1410REM This is done by going to the first line of each
1420REM in the order they are to execute.
1430REM This line must have the form:
1440REM CALLcreate%:IF?return% THEN <next task, or back to initialisation>
1450REM Once each task has been created, the system is started
1460REM by specifying the first task with:
1470REM ?next_task%=<2 * task number - 2> Task numbers are 1,2,3,...
1480REM Generally, you start with task 1, so this line says ?next_task%=0
1490REM Then start the timer by
1500REM *FX14,5
1510REM CALLtimer%
1520REM Then GOTO the first line of the
1530REM first task (i.e. the line containing CALLcreate% for that task)

1540REM
1550REM Each task must have a number of checkpoints
1560REM These are places where a change to the next
1570REM task can occur. Checkpoints are
1580REM simply the statement CALLcheck%
1590REM This will either continue with the next statement (if the slice has not
ended)
1600REM or go on to the next task (cyclically) otherwise.
1610REM Alternatively, the statements CALLevent%:CALLcheck%
1620REM always passes on to the next task
1630REM When a task is resumed, it continues at
1640REM the statement following the CALLcheck%
1650REM The first time a task is entered, it executes from the statement
1660REM after the IF ?return%=1THEN... which followed the CALLcreate%

1670REM
1680REM It is possible to fiddle it so that the next task to be executed is
1690REM the next one in sequence by the statement:
1700REM ?next_task%=<2 * next task number - 2>

1710REM
1720DEFPROCKernel(slice%,tasks%)
1730tasks%=tasks%*2:DIM task% tasks%-1:next_task%=&00:max_task%=&B1:check_flag%
=&02:return%=&B3:timdat%=&B4
1740?next_task%=0:?max_task%=tasks% AND &FF
1750DIMSsave% 130
1760osword=&FFF1:!(timdat%)=slice%:timdat%?4=&FF
1770FORc=0TOopt STEPopt
1780P%=save%:LOPTc \save BASIC line pointer
1790 ldx next_task%:lda &B:sta task%,X
1800 ldx &C:sta task%+1,X:rts
1810]
1820restore%=P%:LOPTc \restore BASIC line pointer
1830 ldx next_task%:lda task%,X:sta &B
1840 ldx task%+1,X:sta &C:rts
1850]
```

```

1860create%=P%:LOPTc \examine task table, and assign new task if necessary
1870 ldx f0
1880.btest lda &B:cmp task%,X:beq ctest
1890 beq ctest
1900.loop inx:inx:cpx max_task%:bmi btest
1910 jsr save%:ldx next_task%:inx:inx:stx next_task%:lda f1:sta return%:rts
1920.ctest lda &C:cmp task%+1,X:bne loop
1930 lda f0:sta return%:rts
1940J
1950timer%=P%:LOPTc \set up interval timer
1960 ldx f(timdat% AND &FF)
1970 ldy f(timdat% AND &FF00) DIV &100
1980 lda f4:jmp osword
1990J
2000event%=P%:LOPTc \here on a 'timer crossing 0' event
2010 pha:lda f1:sta check_flag%:pla:rts
2020J
2030check%=P%:LOPTc \see if it's time for the next task, and change if so
2040 lda f0:cmp check_flag%:bne newtsk
2050 rts
2060.newtsk jsr save%
2070 inx:inx:cpx max_task%:bne norst
2080 ldx f0
2090.norst stx next_task%:jsr restore%
2100 lda f0:sta check_flag%:jmp timer%
2110J
2120NEXTc
2130FORIX=task% TO task%+tasks%-1?IX=0:NEXT
2140?&220=event% AND &FF:?&221=(event% AND &FF00) DIV &100
2150ENDPROC

```

Listing 2.

```

10REM *** A Simple Multi-tasking Program ***
20REM
30REM David Elworthy - September 1984
40*FX13 5
50opt=2:PROCKernel(&FFFFFFF0,5)
60GOTO150 :REM create the tasks
70?next_task%=0:*FX14 5
80 CALLtimer%:GOTO150 :REM activate the tasks
90MODE7:CLOSEf0:END :REM return here at 'closedown'

100REM
110REM *** Tasks start here ***
120REM
130REM Task 1 - input and closedown
140REM
150CALLcreate%:IF ?return% THEN 360
160MODE4:PROCKwindow
170DIM tape% 500:s%=0:e%=0: REM tape buffer
180DIMT$(3) :REM array used for time
190P$="":F$=""
200reading%=FALSE:displaying%=FALSE:timing%=FALSE
210CALLcheck%:I$=INKEY$(0)
220IF I$="" THENCALLevent%:CALLcheck%:GOTO210
230PRINT:REPEAT:IFASC I$=127 THENP$=LEFT$(P$,LEN(P$)-1):GOTO250
240P$=P$+I$
250PRINTI$;:I$=GET$:UNTIL ASC I$=&0D
260P$=P$+CHR$ &0D
270PRINT
280CALLcheck%
290IFFNparameter("X") THEN 90 :REM check for 'closedown' command
300IFFNparameter("Q") THENCLS
310IF INSTR("XQTOCDE",LEFT$(P$,1))=0 THENdummy=FNparameter("?"):PRINT"Unknown
command: "C$
320GOTO210

330REM
340REM Task 2 - time
350REM
360CALLcreate%:IF ?return% THEN 540
370IFFNparameter("T") THEN 390 ELSEIFtiming% THEN 420
380CALLevent%:CALLcheck%:GOTO370
390TIME=((VAL MID$(C$,2,2) *60 + VAL MID$(C$,4,2) ) *60 + VAL MID$(C$,6,2) ) *
100
400timing%=TRUE :REM time now set
410CALLcheck%
420REM here to display time
430T%=TIME:T$(1)=STR$(T% DIV 360000)MOD 24)
440T$(2)=STR$(T% DIV 6000)MOD 60):T$(3)=STR$(T% DIV 100) MOD 60)
450CALLcheck%
460FORIX=1TO3:IFLEN(T$(IX))=1THEN T$(IX)="0"+T$(IX)
470NEXT
480CALLcheck%:PROCKwindow:CLS
490PRINTT$(1);":":T$(2);":":T$(3);
500PROCKdisplaywindow:GOTO380

510REM
520REM Task 3 - tape input
530REM
540CALLcreate%:IF ?return% THEN 700
550IFFNparameter("O")THEN 620 ELSEIFFNparameter("C") THEN 660
560IFNOTreading% THEN CALLevent%:CALLcheck%:GOTO550
570IFEOFf% THENPRINT"End of file reached":GOTO660
580B%=BGETf%
590IFFNused=500 THENPRINT"Buffer full...waiting for space":REPEAT:CALLcheck%:
UNTILFNused<500
600tape%?e%=B%:e%=(e%+1) MOD 501

```

(listing continued on next page)

pointer is stored in locations &0B-C. Thus, by examining and adjusting the value at this address it is possible to circumvent the normal order of execution of the program.

Listing 1 shows the kernel of routines to do these two things. Most of the details are given in the Remarks, but a few supplementary comments may be useful. Lines 1720 to 1760 define a few necessary variables. Task% is a region of memory containing two bytes for each task, in which the values of the line pointer from &0B-C will be preserved. The zero page locations &80-3 are used for various parameters to the kernel routines.

Timdat%, the five bytes &84-8, contains the values to be loaded into the interval timer, thus defining the length of the time slice to be allocated to each task. The value is taken from Slice%, an argument to the kernel, and is equal to the negative of the length of each slice in hundredths of a second. For example, the value of &FFFFFFF0, or -16 decimal, makes each slice 16/100 of a second long. The interval timer is actually a 40-bit counter, but in practice the lower four bytes are sufficient for all likely applications: it limits the maximum length of a slice to a mere 2**32/100 seconds, or roughly 1.4 years. The highest byte of the timer is always loaded with &FF.

Of the six machine-code routines, Save% in line 1780 and Restore% in line 1820 should never be needed by individual tasks. They simply save and restore the Basic line pointer from a position in the task table given by Next Task%. Timer% in line 1950 sets the timer, and Event% in line 2000 is called when it reaches zero. These variables may occasionally be called from tasks, but most important are the remaining routines. Create% in line 1860 is used to bring the various tasks into existence.

At the start of each task there should be a line which says

```
CALL create%: IF ?return% THEN
< line number of next task >
```

When called, Create% looks through the list of Basic line pointers in Task % to see if it has been called from this line before. If it has not, it records the current line pointer in the Task% table and places the value 1 in location ?return%. The If test then moves on to a similar line at the beginning of the next task, until it comes to the last task when it should be directed back into the initialisation routine. If, however, the line is being executed for the second time, Create% will place the value 0 in ?return%, the If will fail and the task starts with the next statement.

Finally, Check%, in line 2030, must be called by each task from time to time, to see if the slice has ended. If it has, the current line pointer will be logged in the Task% table and the line pointer for the next task placed in location &0B-C, so that the statement indicated by that pointer is

(continued on next page)

Basic multi-tasking

(continued from previous page)

the next one executed, rather than the one which follows the Call to this routine. The first time a task is invoked in this way, its line pointer in the task's first line and ?return% will be zero.

It is possible for a task to steal extra time by either calling Check% only rarely, or by altering the timer value. If a task is not doing anything, the statements

CALL event%: CALL check% will mean that control goes on to the next task immediately, regardless of whether the slice has finished. The timer is reset to its initialisation value on a successful check, so the next task will still only get its usual slice.

An example application, shown in listing 2, illustrates what initialisation is necessary and how to use the kernel. Lines 40 to 80 contain the initialisation. Something similar to this will appear in every program which uses the kernel.

Line 40 disables timer events while things are set up. Line 50 assembles the routines, with a time slice of 16/100 seconds. Opt is used by BBC Basic's assembler: 2 specifies no listing. Line 60 sends the program to the Create line of task 1, and then through the first line of each task — lines 150, 360, 540, 700 and 820 — eventually coming back to 70 when all the tasks have been created. Line 70 indicates task 1 as being the first, and enables timer events. Line 80 sets the timer going and goes to line 150 for the second time. From now on the tasks themselves are active. Control only comes back to line 90 if a task specifically causes it.

There are five tasks, with varying degrees of interconnection. From the user's point of view, the commands available are

X — exit from the program.

Q — clear screen.

Thhmmss — set the time to hh:mm:ss.

The current time is subsequently displayed in the top left-hand corner of the screen.

Ofilename — open the specified file, and read characters from it into a buffer.

C — close file.

D — display any characters in the file buffer. Characters outside the normal range of displayable ASCII are shown as their ASCII value in decimal.

E — cancel D.

(listing continued from previous page)

```

610CALLcheck%:GOTO550
620REM open file
630PRINT"Waiting for tape...":F$=MID$(C$,2):F%=OPENIN(F$)
640PRINT"File "F$" opened"
650CALLcheck%:reading%=TRUE:GOTO610
660PRINT"File "F$" closed":reading%=FALSE:GOTO610

670REM
680REM Task 4 - display
690REM
700CALLcreate%:IF ?return% THEN 820
710IFFNparameter("D") THEN740 ELSEIFFNparameter("E") THEN720 ELSE IFdisplaying
% THEN 740 ELSE 730
720displaying%=FALSE
730CALLevent%:CALLcheck%:GOTO710
740REM Here when displaying
750displaying%=TRUE
760CALLcheck%:IFFNused<=0 THEN 710
770D%=tape%?s%:IFD%<320RD%>126THENPRINT"<"+STR$(D%)+>"; ELSEPRINTCHR$(D%);
780CALLcheck%:s%=(s%+1) MOD 501:GOTO760

790REM
800REM Task 5 - gremlin
810REM
820CALLcreate%:IF ?return% THEN 70
830VDU23,130,20,28,8,127,8,20,34,34: REM Define the gremlin
840GX%=1279:GY%=1023
850CALLcheck%
860VDU5:MOVEGX%,GY%:PRINT" "+CHR$(127);
870VDU4:CALLcheck%
880GX%=RND(1279):GY%=RND(1023)
890FORGI%=1TO1000+RND(3000):NEXT:CALLcheck%
900VDU5:MOVEGX%,GY%:PRINTCHR$(130);
910VDU4
920FORGI%=1TO1000+RND(5000):NEXT:GOTO850

930REM
940REM *** Miscellaneous PROCs and FNs
950REM
960 REM returns how much of tape buffer is used
970DEFFNused
980 IFs%<=e% THEN =e%-s%
990 =e%-s%+501
1000
1010DEFFNparameter(q$)
1020 LOCAL C%
1030 REM examine the parameter string to see if it starts with q$, and if so,
1040 REM remove all the characters up to the first CR into C$, returning TRUE
1050 REM q$="?" matches anything
1060 IFq$="?" THEN1080
1070 IFASC P$<>ASC q$ THEN =FALSE
1080 C%=INSTR(P$,CHR$(80D))
1090 C%=LEFT$(P$,C%-1):P%=MID$(P$,C%+1)
1100=TRUE
1110
1120DEFFPROCwindow
1130 VDU28,0,31,39,4
1140ENDPROC
1150
1160DEFFPROCtimewindow
1170 dx%=POS:dy%=VPOS:VDU28,0,3,8,2
1180ENDPROC
1190
1200DEFFPROCdisplaywindow
1210 PROCwindow:PRINTTAB(dx%,dy%);
1220ENDPROC

```

The various tasks divide the commands between them. Task 1 handles input and does the X and Q commands. If nothing has been typed, it does not wait around but goes straight on to task 2, line 220. However, as soon as any key is pressed, it does not allow any other task to execute until the complete line has been entered and Return has been pressed.

Task 2 allows the time to be set using the T command, and displays it once it has been. Task 3 reads from the file, and includes all necessary checks for end-of-file, full buffer, etc. The buffer of characters read may only be emptied by displaying them, using the D command. As with task 1, this may suspend the other tasks while it waits for input from the file. The C command is also handled here. Task 4 displays a character from the buffer, the D and E command.

The final task is entirely independent of

the others. It causes a malicious gremlin to appear at random points on the screen and make holes in the text.

The tasks communicate with each other through a number of variables; there should be other variables in common between them. Examples are the status flags Timing%, Reading% and Displaying%, and the input string PS which, by means of FNparameter, offers the commands to each task in turn. It is advisable to call Check% after any sequence of commands that may take some time to make sure that each task gets its fair share of time. See lines 420 to 450, and 890, for example.

You must never call Check% inside a block such as a Proc, FN, Repeat-Until, Gosub-Return, or For-Next. It might be safe, but more often than not the program will end up returning somewhere unexpected. 

THE SPECTRUM BASIC COMPILER



UP TO 40 x SPEED INCREASE

- ★ **BLAST!** is the first fully compatible OPTIMISING BASIC COMPILER for the Sinclair ZX Spectrum and Spectrum +.
- ★ **BLAST!** will compile ANY BASIC program, without alteration.
- ★ **BLAST!** will take your BASIC programs and transform them into super-efficient code running at up to forty times the speed of BASIC.
- ★ **BLAST!** can produce both native machine code and a compact p-code, for programs where space is at a premium.
- ★ When you have **BLASTED** your programs you are free to distribute or sell the results without any restriction.

SIMPLICITY ITSELF

Using **BLAST!** couldn't be simpler. Just load it with your BASIC program and press "C" to compile. In a few seconds the compiled program is ready. Just type RUN and see your software run up to forty times faster.

OPTIMISATION

BLAST! doesn't just compile your programs; it also applies a range of sophisticated optimisation techniques to enhance the performance of the compiled code. Any program can be compiled without alteration, but we think you will enjoy the wide range of extensions to BASIC built into **BLAST!** **BLAST!** features genuine integer variables, debugging facilities, program protection, and much more. It will operate in resident mode, or with tape or microdrive.

TOOLKIT INCLUDED

BLAST! provides the complete BASIC programmer's package. As well as a sophisticated compiler **BLAST!** includes a comprehensive toolkit with a full range of features including renumber, single-step, search and replace, and block handling operations. Use it to test and develop your BASIC programs before compiling them: with **BLAST!**

STOP PRESS — OXFORD PASCAL

OXFORD PASCAL is now available for the SPECTRUM as well as the C64 and the BBC 'B'. To call us for details dial 100 and ask for FREEPHONE PASCAL.

Price/availability matrix		SPECTRUM	C64	BBC 'B'
BLAST BASIC		£24.95	N/A	N/A
OXFORD PASCAL	DISK	N/A	£49.95	£49.95
	CASSETTE	£24.95	£22.95	£39.95

All prices are inclusive of VAT
Please add £2.00 for postage and packing.



Please rush me my copy of

My computer is SPECTRUM BBC 64 Please supply CASSETTE DISK

I enclose £..... including £2.00 p&p Please make cheques payable to OCSS Ltd.

Name:

Address:

.....

.....

.....

Postcode:

Telephone:



Oxford Computer Systems (Software) Ltd.
Hensington Road, Woodstock, Oxford OX7 1JR, England
Telephone (0993) 812700 Telex 83147 Ref. OCSL



The MICROLINE 82A

FROM EXCELLENCE THE NEW OKI

Above we show you two printers (to the same scale). On the left is the OKI MICROLINE 82A - one of the most successful standard dot matrix printers ever manufactured. On the right is the printer that will become the NEW standard for dot matrix printers - the new MICROLINE 182 - from OKI.

In the past OKI have always achieved excellence in their printer products - now we believe they've reached perfection! OKI's revolutionary design concept for the new Microlines sets hitherto unparalleled standards of performance, styling - and price.

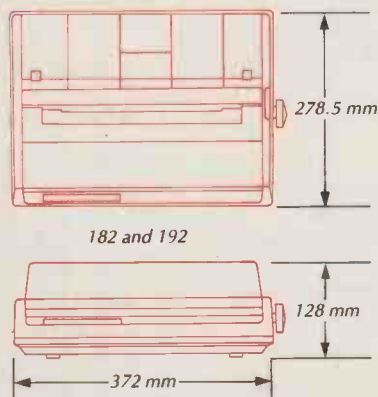

The dimensions of the larger Microline 193 are, length 524 mm, width 278.5 mm and height 128 mm. These dimensions do not include the platen and tractor unit.

The new MICROLINE 182 is the first of a whole new range of printers from OKI which fulfil all the requirements of today's printing needs. With operating noise level reduced to an almost unbelievable 58dB. and a print speed of 120 characters/second, listings, invoices and many other applications are all handled quietly, with upmost speed and efficiency. If your requirement is for high resolution computer graphics, the MICROLINE 182 will reproduce your screen images with a degree of accuracy never before seen from a matrix printer. True underlining, superscript and subscript are

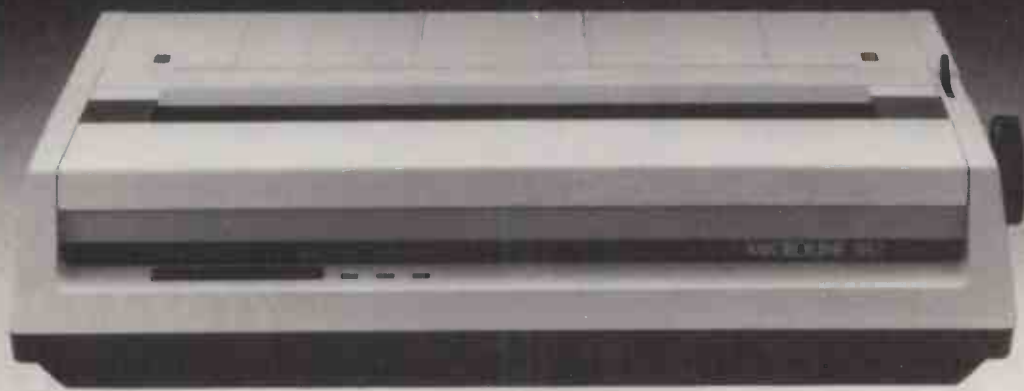

The new MICROLINE 182 to the same scale as the 82A

TO PERFECTION MICROLINES

OKI IS O.K.

also incorporated as standard. In addition a new concept in ribbon design, allows a single action 'clean hands' operation.

But that's not all - complementing the new styling and incorporating even more features are the MICROLINE 192 and 193. Both have the same incredibly high specification as the 182 - PLUS

- Even faster throughput (160 cps)
- Correspondence quality printing
- Down line loadable character font memory - with battery back-up
- Operator selectable default settings.

OKI



X-DATA

A Subsidiary of *Dyneer* Corporation

X-DATA Ltd. 750/751 Deal Avenue
Slough Trading Estate Berks SL1 4SH
Tel: Slough, (0753) 72331 Tlx. 847728

The reputation of OKI MICROLINE printers was built on excellence of quality and reliability. The new Microlines are no exception - even higher quality, greater reliability and performance bring the new generation of OKI MICROLINE printers - to near perfection.

Contact your local dealer for more details of the new generation from OKI or contact us directly at the address below. Insist on perfection.... insist on OKI.

● Circle No. 160

WHEN IT COMES TO SERVICE ...

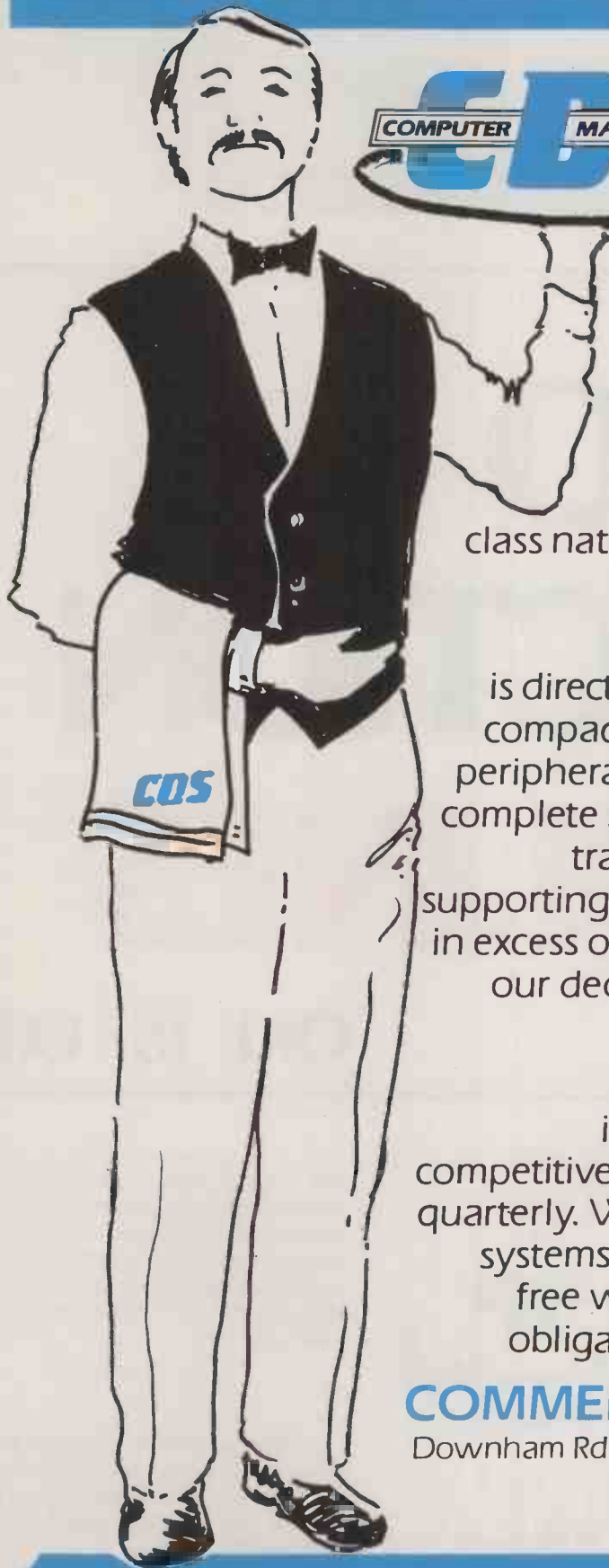

YOU DON'T HAVE TO HAND IT TO US!

For Starters! we come to you, our fully trained engineers are strategically based throughout the UK providing a first class nationwide on site maintenance service for your micro computer equipment.

Our Main Course is directed to Apple, IBM, Sirius, Apricot and compaq micros and most importantly "their peripherals." In fact we provide cover for your complete system. With over 50 engineers fully trained on each of the above products, supporting a customer base of micro computers in excess of £12,000,000, you can be assured of our dedication and commitment to support your hardware.

Our Sweetener is simply the best service for the most competitive rates, there's even the option to pay quarterly. Whether for just one or one hundred systems ring our national sales division for a free written quotation with absolutely no obligation — **we don't even ask for a tip.**

COMMERCIAL DATA SYSTEMS LTD

Downham Rd., Ramsden Heath, Billericay, Essex CM11 1PU

☎ 0268 710292

File lister

The contents of a CP/M file can be read a screenful at a time if you use John and Timothy Lee's SList utility.

CP/M CONTAINS the intrinsic function Type which is used to list the contents of a named file on the console device. In CP/M jargon the console device is simply the terminal used to communicate with CP/M; it normally consists of a keyboard to input information, and either a printing terminal or a VDU screen to display messages and results.

The Type function was devised in the early days of CP/M, when Teletypes were commonly used as the console device. Because a Teletype prints on paper, operating at only 110 baud, it was always possible to read the information listed by Type. Today Teletypes are seldom used, except possibly as a slow and noisy printer by those who cannot afford anything better.

Console devices in current systems are likely to be either a high-speed VDU or a video interface inside the computer. On these video terminals, the Type function is inadequate because the file is usually listed too fast for you to read, and it scrolls off the screen before you can read it. Neither the Type function nor the CP/M operating system itself has any provision for paging, which would halt the listing when the screen fills up. The only way round the problem is to suspend the listing to the screen by typing a Control-S, and to resume listing by typing any character. This requires nimble finger work, and if you press any key other than Control-S then the listing is discontinued and you return to CP/M and have to start again.

Another problem with the Type function is that it sends each character from the file to the console, regardless of whether the character is printable or not. Any control characters in the file usually upset the video system, and may leave all the characters on the screen flashing or in inverse mode; they may even clear the screen. This almost always happens if you accidentally use the Type command on a machine-code .Com file. WordStar files also upset the video system, since WordStar stores print enhancements, such as Bold, Underline, Subscript, etc., as control characters.

The SList program overcomes these problems. When assembled it occupies less than 1K, so room can be found for it on most working discs. SList is used by typing

SList filename.extension

In just the same way as

TYPE filename.extension

is used to list a file on the screen.

SList stops listing to the screen when the screen is full, giving you as much time as

you like to read the text. The bottom line on the screen displays a message which invites you either to type L to list the next line, or to type any other character to display the next screenful. You can thus scroll rapidly until you reach the part of the file you are interested in, and then advance a line at a time.

In SList long lines are handled in a predictable manner. Many 80-column video terminals automatically move to the start of a new line once 80 characters have been received, but some do not. SList will, if necessary, insert the required Carriage Return, Linefeed, and in either case SList counts the number of lines that are actually displayed, rather than the number of source lines, to determine when the screen is full.

Control characters are filtered out by SList, so there is no danger of the video being confused. Finally, after SList has displayed the entire file, a message printed on the bottom line of the screen offers the option of listing the file again.

The program listing for SList itself includes both the source code and comments in Intel mnemonics, together with the hexadecimal code produced by the CP/M assembler ASM. The following steps must be followed to produce an executable .Com file. First type in the mnemonics into a file called SList.ASM. Then type the command

ASM SLIST

to make the CP/M assembler produce a

.Hex hexadecimal file. Finally type
LOAD SLIST

to produce an executable file called SList.Com.

The SList program works correctly on screens which display 24 lines of 80 characters, and automatically moves on to the next line when column 80 is used. To adapt it for other screen displays these values may be changed by altering the values of NLines, NCols and AutoLF in three lines at the start of the listing.

The SList program uses inverse video to distinguish between lines of text from the file being listed, and messages from SList itself. You could, alternatively, highlight by giving half intensity, flashing or colour, if available on your terminal. Highlighting is invoked using different codes on different terminals; those in the listing are for a North Star Advantage.

SList send two bytes to start highlighting and two bytes to stop. They are defined at the start of the SList program and are called Hi1 and Hi2, and UnHi1 and UnHi2. On the Advantage, inverse video codes are Control-A to start and Control-B to stop; thus Hi1 is set to 1 and UnHi1 is set to 2. Hi2 and UnHi2 are not needed and are set to zero. The SList program will function correctly without highlighting of any description, so if you are using a dumb terminal like the ADM-3A or if you do not know how to get highlighting on your terminal then you should set all four bytes to zero.

```

0100                                ORG     100H
;                                     Personalisable Features
0001 = HI EQU 01 ;Start Highlight Code
0002 = UNHI EQU 02 ;Stop highlight code
0050 = NCOLS EQU 80 ;Number of columns on screen
0018 = NLINES EQU 24 ;Number of lines on screen
0001 = AUTOLF EQU 1 ;Non-zero implies auto-lf
;done by terminal

0100 C33F01 JMP START
0103 0D0A0A534C DB CR,LF,LF,'SList version 2.3'
0117 0D0A777269 DB CR,LF,'written by T.D.Lee'
012B 0D0A446174 DB CR,LF,'Date 7 Jan 1984',CR,LF,26

0009 = TAB EQU 9 ;ASCII TAB character
000A = LF EQU 10 ;ASCII LineFeed
000D = CR EQU 13 ;ASCII Carriage Return

0005 = CPM EQU 5 ;Address to call CP/M
005C = FCB EQU 05CH ;Address of default FCB
0080 = BUFFER EQU 080H ;Address of default buffer
0001 = CONIN EQU 1 ;CP/M CONsole INput command
0002 = CONOUT EQU 2 ;CP/M CONsole OUTput command
0009 = PRINTS EQU 9 ;CP/M PRINT String command
000F = OPENF EQU 15 ;CP/M OPEN File command
0014 = READS EQU 20 ;CP/M READ Sector command
    
```

(continued on page 135)

If you want it tomorrow . . .
call us today
01-455 9823

COMPUTERS/CALCULATORS/PLOTTERS

HEWLETT PACKARD		PL 5000 Portable Computer	£1190.00
HP 4 1CV (ISCi Computer)	£169.95	CE 158 RS232 and Cent IF	£120.00
HP 4 1CX (Computer)	£259.00	CE 150 printer cassette IF	£125.00
HP 4 1C (Card Reader)	£163.50	CE 159 8K Add on mem with BAT	£79.00
HP 4 1C Printer 82143A	£230.00	CE 152 Cassette	£36.00
HP 4 1C Cassette drive	£290.00	PC 1251 (Computer)	£66.50
HP 16C (Hex Con)	£100.00	CE 125 (I/F for above)	£86.50
HP 15C (Adv Sci)	£100.00	Casio PB 700 (h/held Computer exp to 16K)	127.00
HP 71C (portable computer)	£410.00	Casio PB 750 New Computer	£89.50
HP 71 Printer 82162A	£395.00	Epson QX-10 (desk top comp)	£1599.00
PLOTTERS		EPSON HX20 Brlfcase computer. 16K expandable. Serial and RS232 interface.	£375
HP 7470A (A4 2 Pen Plotter)	£918.00	EPSON PX-8 (portable 64K Computer/Word Processor)	£775.00
HP 7475 (A3 6 Pen Plotter)	£1550.00	Epson Modem CX21 (300 Baud)	160.00
Pixy Plotter (A4 3 Pen 8 Colour)	£399.00		
Epson H180 Plotter	£375.00		
SHARP PC 1500A (P/Computer with 8K ext to 24K)	£147.50		

WORD PROCESSING PRINTERS/MONITORS

7710 RS232/7730 Cent	£1440.00	BROTHER* Highly recommended*	
NEC 2000 (20 CPS)	£615.00	HR1 (16CPS)	£265.00
NEC 3530 (33 CPS)	£1300.00	HR15 (3K Buffer 18CPS)	£325.00
SILVER REED		HR25 (3K Buffer 25CPS)	£555.00
EXP 500 (12CPS)	£299.00	HR35 (35CPS)	£695.00
EXP 770 (31CPS-2K Buffer)	£850.00	CANON Jet Printer (37CPS-7 colour)	£450.00
Sheet feeder for above	£185.05	HP Jet Printer (150CPS)	£425.00
MT EXP 500 (19 CPS)	£329.00	DIABLO	
SMITH CORONA		620 (RO)	£650.00
S/C TPI (12CPS)	£154.00	630 (ECS/IBM)	£1650.00
S/C L100 (12 CPS-cmulates Diabolo 630 Protocols)	£260.00	630 (API) (IBM COM)	£1295.00
QUME 9/45 RO-FFP	£1900.00	630 (KSR)	£1840.00
12/20 (20CPS)	£499.00	Tractor (BiDi)	£195.00
11/40 RO (Also IBM-PC7)	£1185.00	FUJITSU	
TEC STARWRITER		EPSON DX 100 (13CPS)	£399.00
F10-55 CPS (serial/parallel)	£1175.00	Sheet Feeder	
Tractor (Bi-Di)		RUTISHAUSER	
Sheet Feeder		Sheet Feeders and Tractors for: Qume, Diablo, NEC, Ricoh, TEC Starwriter, Olivetti, etc.	From £99.00
Mechanical Sheet Feeder		RICOH*	
OLYMPIA*		Model RP 1300 (S) (4K Buffer)	£875.00
ESW 103	£800.00	Flowriter (8K) PR 1600	£1244.00
TOSHIBA		IBM-PC Version	£1500.00
The all speed - Word Processing/Data Processing printer		Mechanical Sheet Feeder	£459.00
JUKI 6100 (18CPS)	£319.00	RP 1200 (20CPS)	£555.00
JUKI 6300 (40CPS)	£825.00		
TEC Starwriter from	£890.00		

COLOUR MONITORS from £220
Monochrome Monitors from £54.00

DOT MATRIX PRINTERS

OKI		SMITH CORONA	
M82A (120CPS)	£240.00	Fastext 80 (80CPS)	£195.00
M92P (160CPS)	£360.00	D100 (120CPS)	£249.00
M83A (12CPS)	£389.00	SEIKOSHA from	£99.00
M84P (200CPS)	£625.00	MANNESMAN TALLY	
ANADEX*		MT80 plus (100CPS)	£185.00
DP-9000 B/(180 CPS)	£850.00	MT160 (F/T) (160CPS)	£399.00
DP-9500 B/(180 CPS)	£893.00	MT180 (160CPS 32 Col)	£579.00
DP-9625 B/(240 CPS)	£1155.00	EPSON	
BROTHER		Epson RX80T (100CPS)	£190.00
EP44 (16CPS)	£189.00	Epson FX80 (160CPS)	£320.00
HR 5 (30CPS)	£129.00	Epson RX80FT	£215.00
Brother M1009 IBM (50LPS)	£159.00	Epson FX 100FT (160CPS)	£425.00
STAR range from	£156.00	Epson RX 100FT (100cps)	£340.00
CANON PW1080A (160CPS)	£274.00	Epson LQ1500 (200cps)	£875.00
CANON PW1156A (160CPS)	£355.00	TEC 1550 (180CPS)	£575.00
NEC Pinwriter (132 cols) P3	£595.00		
MODEMS (Dacorn/Master/Epson etc.) from	£79.00		
SHINWA CP80/II/FT	£165.00		

TECHNICAL ADVICE

01-455 9824

This is only part of our range, a telephone call will save you time and money

SOFTWARE

This is only a selection of programmes available - telephone us for your specific requirements.

APPLE II/e		IBM/COMPAQ	
Mailmerge V.3.3	£125.00	Wordstar V.3.35	£270.00
Wordstar V.3.31	£270.00	Mailmerge V.3.24	£125.00
Wordstar/Mailmerge/Spellstar	£406.00	Lotus 1-2-3	£325.00
ACT-APRICOT		Symphony	£450.00
Pulsar-Wordstar	£250.00	dBase II (CP/M86)	£295.00
Mail Merge	£75.00		
Superwriter	£250.00		

EXPORT ORDERS WELCOMED

GOODS FULLY GUARANTEED PRICES EXCLUDING VAT AND P+P.

Company and Government orders accepted by phone. Barclaycard Access Visa accepted by phone.

Tel.: 01-455 9823

MOUNTAINDENE

22 Cowper Street London EC2

● Circle No. 135

THE ONLY \$100 WORTH REMEMBERING.



Our range includes 6 different memory cards.

HIGH TECHNOLOGY ELECTRONICS LTD., 303/305 PORTSWOOD ROAD, SOUTHAMPTON, SO2 1LD. TEL: (0703) 581555 TELEX: 477465 HTEL G.

● Circle No. 118

THE ASSOCIATION OF LONDON COMPUTER CLUBS PRESENTS



Software, Hardware, Peripherals and bits for all micros

Free unbiased advice from the club stands
Bring-and-Buy Sale on the Saturday

Plus

Other Features

Robotics Conference Network Features

Community Computing

Admission Adults £2.50 Under 12's £1.50

RESERVE THE DATES NOW!
THE CULMINATING EVENT OF THE

The Personal Computer Show for EVERYONE
Further information from PATRICIA SPILSBURY
01-303 8849



COMPUTING FOR LONDON.

● Circle No. 140

PRACTICAL COMPUTING April 1985

(continued from previous page)

```

; Prints CR LF on-screen
;
0348 3E0D      CRLF: MVI A,CR
034A CD4F03    OUTPUT
034D 3E0A      MVI A,LF
;
; OUTPUT Subroutine
;
; Print the character in the A register on the screen
; unless it is a Control Character.
; If character is printable increment the COL position
; If character is CR reset COL position to 0
;
034F F5       OUTPUT: PUSH PSW
0350 C5       PUSH B
;
0351 E67F     ANI 07FH
0353 CD7703   CALL CONTRL
0356 CA7403   JZ  OUTPT3
;
0359 F5       PUSH PSW
035A 5F       MOV E,A
035B 0E02     MVI C,CONOUT
035D CD0500   CALL CPM
0360 F1       POP PSW
;
0361 FE0A     CPI LF
0363 CA7403   JZ  OUTPT3
0366 FE0D     CPI CR
0368 3E00     MVI A,0
036A CA7103   JZ  OUTPT2
036D 3AD203   LDA COL
0370 3C       INR A
0371 3D2D03   OUTPT2: STA COL
;
0374 C1       OUTPT3: POP B
0375 F1       POP PSW
0376 C9       RET
;
; CONTR Subroutine
;
; Tests if character in A register is printable.
; and returns with Z flag set if Character is a
; Control Character other than CR or LF
;
CONTRL: CPI ' '
; JZ  CONTR2
; CPI LF
; JZ  CONTR2
; CPI CR
; JZ  CONTR2
; CPI A,0
; JZ  CONTR2
; MVI A,0
CONTR2: ORA A
; RET
;
; GETKEY Subroutine
;
; Get a character from the Keyboard
; Reboot CP/M if it is Control C
;
038A 0E01     GETKEY: MVI C,CONIN
038C CD0500   CALL CPM
038F FE03     CPI 3
0391 CA0000   JZ  0
0394 C9       RET
;
; GETCHR Subroutine
;
; This subroutine gets a byte from disk
; If the byte is a TAB character, it is expanded as
; a sequence of spaces
;
0395 3AD203   GETCHR: LDA COL
0398 E607     ANI 7
039A CA4403   JZ  GETCH2
;
039D 3AD303   LDA TABFL
03A0 B7       ORA A
03A1 C2B203   JNZ GETCH3
;
03A4 3E00     GETCH2: MVI A,0
03A6 3D303    STA TABFL
03A9 CDB503   CALL GETBYT
03AC FE09     CPI TAB
03AE C0       RNZ
;
; Clear TAB Flag
; Get byte from disk
; and use it as character
; unless it is a TAB
;
03AF 3D303    GETCH3: STA TABFL
03B2 3E20     MVI A,' '
03B4 C9       RET
;
; GETBYT Subroutine
;
; This subroutine gets a byte from the disk file
; The pointer to the file is incremented, and unless
; the input buffer is exhausted a byte from it. If the
; buffer is empty the next sector is read from disk
; and the pointer is reset. If an error occurs when
; reading from the file, ^Z (EOF marker) is returned.
;
03B5 2AD003   GETBYT: LHLD PONITR
03B8 2C       INR L
03B9 C2CB03   JNZ GETBY2
;
03BC 115C00   LXI D,FCB
03BF 0E14     MVI C,READS
03C1 CD0500   CALL CPM
03C4 B7       ORA A
03C5 3E1A     MVI A,26
03C7 C0       RNZ
;
; Get pointer to buffer
; Jump if Char is in buffer
; else
; Read next sector
; Set Flags
; Return ^Z if error
;
03C8 218000   LXI H,BUFFER
03CB 7E       MOV A,M
03CC 22D003   SHLD PONITR
03CF C9       RET
;
03D0 8000     PONITR: DW 080H
03D2 00       COL: DB 0
03D3 00       TABFL: DB 0
03D4         DS 40
;
03FC         STACK: END
;

```



1403 ways to make your performance hit the ceiling without your Accountant hitting the roof.

The famous Inmac Computer Users Ideas Book has the answers to all your accessory and supplies problems. Answers like the Inmac Plus Floppy – guaranteed to work first time, everytime *forever*. Or our ergonomic range of office furniture – furniture actually *designed* around your computer equipment. There are more than 1400 products, all designed to help you get the most out of your computer.

Everything you need!

Cables, sophisticated datacom equipment plus the disks, tapes and cartridges – and stationery – that you want. Everything you need, to help you increase your productivity with some important Inmac extras. 30 day Risk Free Trial, a minimum 1 year guarantee and same or next day delivery.

Best of all, the Inmac Computer Users Ideas book can be yours free. For your free subscription, just call us now or complete and send the coupon.

COMPUTER USERS IDEAS BOOK 21ST EUROPEAN EDITION WINTER 1984/1985
Instant mini/micro computer accessories and cables

inmac

Watch your performance hit the ceiling when you buy Better Value Inmac products.

PRODUCTIVITY CHART

IMPROVED INMAC PLUS FLOPPY DISK

IMPROVED INMAC PLUS FLOPPY DISK

MICROMASTER VIBRA MICROSERIES APPLIED

JAN FEB MAR APR MAY JUNE JULY AUG SEPT OCT NOV DEC

Why no-one can give you better value than Inmac:

- Inmac field-test over 1400 products – and still keep prices low.
- Only Inmac gives you faster, more helpful service – and a 30 day Risk Free Trial.
- No other company can offer you our quality and service at such low prices.
- Remember, only THE best can carry the Inmac label.

01-740-9540 LONDON 09285-67551 RUNCORN 041-248-2948 GLASGOW 021-233-3000 BIRMINGHAM 0272-29166 BRISTOL

YOURS FREE!

**SEND FOR YOUR FREE COPY.
OR PHONE FOR 24 HOUR SERVICE**

Please send me my FREE copy of the Inmac Computer Users Ideas Book – with details of Inmac disks, cables, furniture and datacom equipment – everything I need to make the most of my computer system.

☎ 01-740 9540 LONDON ☎ 09285 67551 RUNCORN

Name (Mr, Mrs, Miss) _____

Title _____

(PLEASE PRINT)

Company _____

Address _____

Post Code _____

Tel No _____

My Computer System is _____

inmac

Inmac (UK) Ltd, 16 Silver Road, London W12 7SG
Inmac (UK) Ltd, Davy Road, Astmoor, Runcorn, Cheshire WA7 1PZ

652

The new TDI Pinnacle – the fastest micro in the world.

Running at 12 MHz, the new TDI Pinnacle will take your breath away!

It can execute a staggering 3 million instructions per second and service 7 users as fast as most personal computers service one.

If you're a Programmer, you'll be delighted that the compiler can handle 3,000 lines per minute.

If you're in Business, Finance, Education or Industry, you can harness TDI Pinnacle's immense speed to the task with a mountainous range of existing software.

One thing's for sure, other micros are having an uphill struggle competing with it. TDI Pinnacle. The accessible peak of performance.



For more information about the new TDI Pinnacle contact TDI Limited, 29 Alma Vale Road, Clifton, Bristol BS8 2HL, telephone Bristol (0272) 742796, or clip the coupon

Send me your free colour brochure on the world's fastest MICRO.

NAME _____

POSITION _____

COMPANY _____

ADDRESS _____

TEL NO. _____

PLEASE TICK

END USER

DEALER

TurboDOS power for multi-user networking



MINSTREL 2

Designed and built in Britain

It's not easy to build an effective multi-user system. It takes experience, confidence and, above all, a superior operating system.

HM Systems possess all three qualities in large supply, and we've put them into Minstrel 2, our latest model.

Experience has shown that multiple workstations and resource-sharing call for multi processor architecture. That way, every user gets their own computer and performance doesn't suffer.

Confidence comes from using proven S100 technology. We've seen too many systems fail by being based on "next year's industry standard". We'd rather settle with this year's working solution. Wouldn't you?

Which is not to say that we're behind the times.

Our state of the art HTS 86 dual processor card was developed to provide two 16 bit computers on a single board.

This means 16 bit computing power at 8 bit prices for you.

We simply prefer evolutionary to revolutionary development.

Make no mistake, any multi user system is only as good as its operating system. Minstrel 2 uses TurboDOS® We've not come across a more flexible and powerful tool.

TurboDOS reads programs written for CP/M II,† CP/M 86, MP/M II, MP/M 86, has PC DOS emulation, and allows IBM PCs or lookalikes to share the resources of a Minstrel 2 system.

Networking is integral.

Minstrel 2 can communicate with all leading mainframes. And we can prove it.

Entry cost for a two-user system with 20Mb hard disk capacity is £6250.00. Additional workstations cost £1110.00 inclusive.

Write or call for a full colour brochure. You won't get a hard sell. With experience, confidence and the best operating system, we find the facts speak for themselves.



HM Systems HTS 86. 16 bit performance at 8 bit prices.

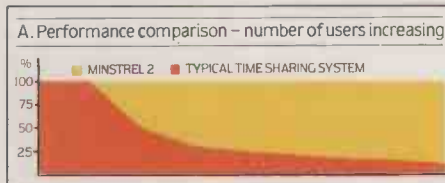

Costs rise and performance suffers when a number of terminals share a common processor. Graph B shows a network of leading stand-alone computers when compared with Minstrel 2. Graph A shows the effect on performance of timesharing compared with Minstrel 2.

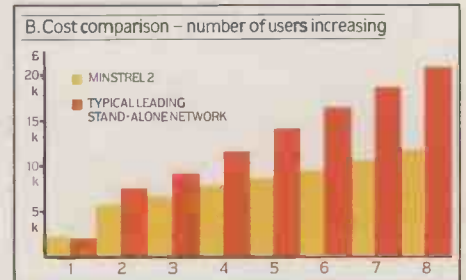

TurboDOS™ TurboDOS is the registered trademark of Software 2000 inc.

†CP/M and MP/M are registered trademarks of Digital Research Inc.

HM Systems Limited,
220 The Vale,
London NW11 8HZ
Telephone: 01-209 0911
Telex: 266828-HMS G
Easylink: 19001060

HM Systems

● Circle No. 164

MORE CREDIT.

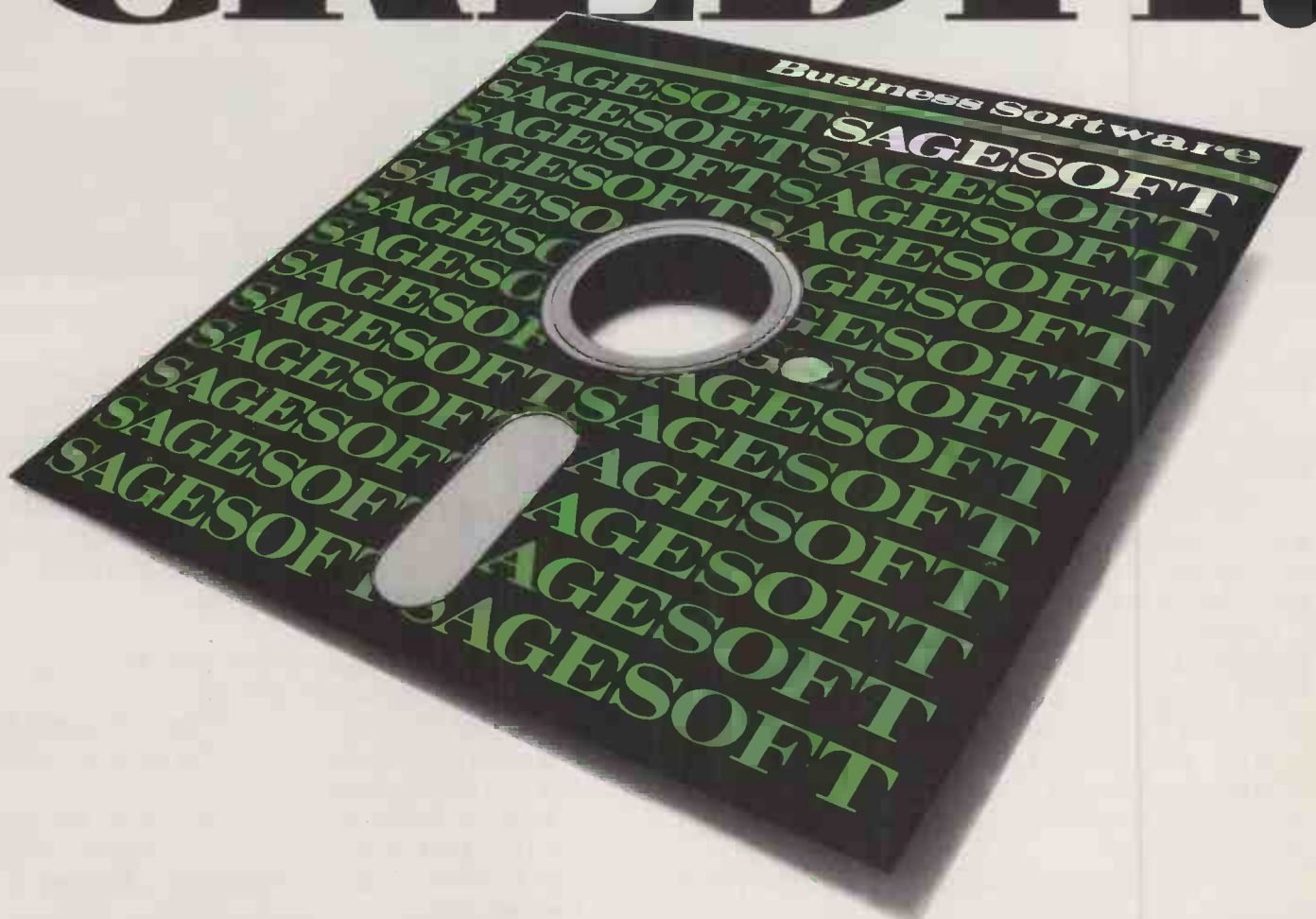

When you're choosing an accounting/book-keeping program, it pays to balance cost against performance.

On the credit side, Sage can offer the only fully integrated one diskette program on the market for £375. Easy-to-learn and easy-to-use, it provides the simple, efficient and inexpensive solution to small business accounting problems.

What's more, Sage Accounts now has even more functions than before • Sales and Purchase Ledgers • Nominal Ledger • Cash Book • Journal Entries • Trial Balance • VAT Return • Monthly and Annual Accounts • Age Analyses • Statements

- Budget Variance Reports • Credit Control Features
- Audit Trail – all together in one compact and comprehensive package.

In addition, Sage Plus provides invoice production linked to stock files and integrated with the sales and nominal ledgers.

Operational problems? Forget them. Sage is suitable for use on most business micros and is fully automatic – which means no shuffling through a pile of disks to find the program you need. It's also complete and self-contained – no expensive modules to buy every time you need a new function.

LESS DEBIT.



All in all, the credit side of Sage is pretty impressive. But more impressive still is the debit side – just £375 for Sage Accounts, £695 for Sage Plus, or £195 for Sage Payroll. That's a fraction of the cost of most of the alternatives. Weigh it up for yourself. Only Sage gives you heavyweight performance at a lightweight price.

MONEY-SAVING PACKAGE DEALS TOO!

Sage Accounts with Payroll £495.

Sage Plus with Payroll £795.

For more details of Sage Accounting Programs, call 01 200 0200 or clip out the coupon.

SAGESOFT

Please send me more details of Sage Accounting Programs and my nearest dealer.

Name: _____

Position: _____

Company: _____

Address: _____

Tel: _____

Sagesoft Limited, NEI House, Regent Centre, Newcastle upon Tyne NE3 3DS. Tel: 091 284 7077. Telex: 53623 SAGESL G. PC2

BETTER SAGE THAN SORRY

● Circle No. 122

Inside OS

Part 3 of the series in which Roger Cullis examines the routines programmed into the BBC Micro's operating-system ROM.

ACCESS to the keyboard is over a slow eight-bit data bus connected to port B of the OS VIA. Read or Write operations are selected by the data direction register. Keyboard input and housekeeping routines are held at &EEDA-F134.

The keyboard is an interrupt-driven device which feeds an input buffer at &03E0-03FF. A two-key rollover is operated; the latest key pressed is stored at &EC and the previous key at &ED. Keys generate internal key numbers which are converted to ASCII codes by a series of look-up tables, indexed by the key number from a base address &EFAB. Interposed between the conversion look-up tables are small routines requiring only a few bytes of code.

Nearly 3K of the operating-system ROM, &F135-FBFF, is devoted to the cassette and ROM filing-system routines. Due to the limited nature of these filing systems, not all of the operations or operating-system calls relating to other filing systems can be fully implemented. For example, if a * command is not executed by the operating system or one of the sideways ROMs it is passed to the current filing system, which will normally attempt to *Run the command. If no file is found within a default time limit, the filing system displays an error message.

Since a cassette tape is open-ended, there is no guarantee that the file will be found within a reasonable time, so the CFS simply does not attempt to execute the operation.

The 6502 microprocessor does not have any I/O capability. Part of its address space, &FC00-FEFF, is therefore devoted to memory-mapped I/O. In the case of OS 1.2 page FC, Fred, is allocated to peripherals and page FD, Jim, to memory accessed over the 1MHz bus. Part of this is reserved for Acorn's expansions, such as a hard-disc controller or the teletext receivers, and part is dedicated to user applications. Page FE, Sheila, is concerned with internal devices and is used to service the peripheral controller chips built into the computer.

After processing a BRK instruction or an interrupt, operation may need to be resumed at the previous point, which may be within a sideways ROM. The routines to do this are held at &F00-FFA5. By

This article forms part of a book to be published by Losco Ltd, PO Box 4, Cranleigh, Surrey GU6 8BQ, price £11.95 plus £1.50 post and packing. A further instalment will appear in next month's *Practical Computing*.

Copyright

This article summarises the operation of the BBC Micro and where the routines are to be found, and is intended to help users to write programs which interact fully with the built-in software. But you should remember that the source code and object code of ROM routines are the subject of copyright and may not be used without the copyright owner's permission. Although you may freely call them from programs running on the computer, you cannot extract or copy them for your own software.

rearranging the stack and storing the identity of the ROM which is active, this can be achieved.

Miscellaneous OS call entry points are held at &FFA6-FFF9. Defined entry points for OS calls are provided to ensure compatibility with future upgrades. The locations of the routines themselves will change as they are rewritten.

On NMI, Reset or IRQ, the 6502 transfers the values stored at &FFFA/B, &FFFC/D or &FFFE/F to its program counter. The operating-system ROM therefore stores the entry points of the corresponding routines at these addresses.

Keyboard input and housekeeping routines.

EEDA :if no key pressed, enable keyboard, reset shift lock, caps lock
EEED :set shift or caps lock as appropriate
EF02 :KEYV entry point - controls keyboard access
EF13 :timer interrupt entry point
EF16 :test shift and control keys
EF74 :set keyboard status, zero autorepeat timer, scan keyboard
EFAB :internal key number to ASCII lookup tables base address
EFC1 :check for ESCAPE, enter processed code in keyboard buffer
EFE9 :scan keyboard, save any key pressed
F00F :key-pressed interrupt entry point
F01F :set autorepeat countdown timer
F02A :write-disable keyboard - write/read keyboard over slow databus
F03B-F044 :internal key number to ASCII lookup table - keys 10-19
F045 :OSBYTE 7B - write current keys pressed
F055 :go to JIM paged entry vector
F04B-F054 :internal key number to ASCII lookup table - keys 20-29
F05B :perform indirected operation
F05B-F064 :internal key number to ASCII lookup table - keys 30-39
F065 :test if any bit set, go to KEYV
F06B :go to KEYV
F06B-F074 :internal key number to ASCII lookup table - keys 40-49
F075-F07A :MOS VIA settings for speech system
F07B-F084 :internal key number to ASCII lookup table - keys 50-59
F085 :OSBYTE 24 - read OSMMN
F08B-F094 :internal key number to ASCII lookup table - keys 60-69
F095 :set buffer number and flush it
F09B-F0A4 :internal key number to ASCII lookup table - keys 70-79
F0A5 :go to event handling routine
F0A8 :OSBYTE 0F - flush selected buffer class

F0AA :flush all buffers
F0B4 :OSBYTE 15 - flush specific buffer
F0B9 :issue *HELP expansion service call, PRINT ROM identity
F0C1 :*OS 1.20* embedded message
F0CC :clear carry and scan keyboard from 16 decimal
F0CD :OSBYTE 79 - keyboard scan from 16 decimal
F0CF :OSBYTE 7A - keyboard scan
F0D1 :scan keyboard (as OSBYTE 79)
F129 :write enable keyboard, blip interrupt enable
F12E :write enable keyboard, transfer X- to A-register

CFS/RFS routines.

F135 :OSBYTE BC - select CFS (*TAP6)
F135 :OSBYTE BD - select ROM filing system (*ROM)
F140 :set OPT interblock gap to default
F14B :initialise CFS and claim vectors
F16B :OSBYTE BF - issue paged ROM service call
F18E :CFS OSAR6S routines - read/write whole file arguments
F1A3 :CFS OSFSC routine vector lookup table
F1B1 :CFS OSFSC routine - filing system control
F1C4 :load file
F1F6 :switch motor off and PRINT "Locked" error message
F1F9 :*Locked* error message
F246 :sound BELL and abort
F249 :PRINT newline if indicated by current block flag
F24D :if CFS not executing operation, PRINT CR
F25A :get filename from OS command line buffer
F27D :CFS OSFILE routines - read or write a whole file
F290 :save load and execute addresses

>BBC ROM ROUTINES

(continued from previous page)

FE62 :USR 6522 VIA data direction - register B
 FE63 :USR 6522 VIA data direction - register A
 FE64 :USR 6522 VIA TIC-L write latches, read counter
 FE65 :USR 6522 VIA TIC-H high order latches
 FE66 :USR 6522 VIA TIL-L low order latches
 FE67 :USR 6522 VIA TIL-H high order latches
 FE68 :USR 6522 VIA T2C-L W-latches, R-counter
 FE69 :USR 6522 VIA T2C-H T2 high order counter
 FE6A :USR 6522 VIA shift register
 FE6B :USR 6522 VIA auxiliary control register
 FE6C :USR 6522 VIA peripheral control register
 FE6D :USR 6522 VIA interrupt flag register
 FE6E :USR 6522 VIA interrupt enable register
 FE6F :USR 6522 VIA as register 1 except no handshake
 FE80 :8721 FDC W-command register, R-status register
 FE81 :8721 FDC W-parameter register R-result register
 FE82 :8721 FDC reset register
 FE83 :8721 FDC W-illegal R-illegal
 FE84 :8721 FDC W-data R-data
 FE8A :68B54 ADLC W-control register 1 R-status register 1
 FE8B :68B54 ADLC W-control register 2/3, R-status register 2/3
 FE8C :68B54 ADLC W-Tx FIFO (frame continue) R-Rx FIFO
 FE8D :68B54 ADLC W-Tx FIFO (frame terminate) R-Rx FIFO
 FE8E :UPD7002 ADC W-data latch A/D start, R-status
 FE8F :UPD7002 ADC hi data byte
 FE90 :UPD7002 ADC lo data byte
 FE91 :TUBE FIF01 flag
 FE92 :TUBE FIF02 flag
 FE93 :TUBE FIF03 flag
 FE94 :TUBE FIF04 flag
 FE95 :TUBE FIF05 flag
 FE96 :TUBE FIF06 flag
 FE97 :TUBE FIF07 flag

BRK and interrupt-handling routines.

FF36 :NETV default entry point

FF56 :on interrupt, process extended vector
 FF89 :discard 3 bytes from bottom of stack, switch ROMs

Miscellaneous OS call entry points.

FFA6 :CFS OS6BPPB - no function implemented, contains RTS opcode
 FFA6 :VDUV default entry point - contains RTS opcode
 FFA6 :IND1V default entry point - contains RTS opcode
 FFA6 :IND2V default entry point - contains RTS opcode
 FFA6 :IND3V default entry point - contains RTS opcode
 FFA7 :OSBYTE 9D - fast BPUT
 FFAA :OSBYTE 92 - read byte from FRED
 FFAE :OSBYTE 94 - read byte from JIM
 FFB2 :OSBYTE 96 - read byte from SHEILA
 FFB6 :default vector table length and location lookup table
 FFB9 :OSDRRM - read from paged ROM
 FFBF :VDU character output
 FFBF :OSEVEN generate an EVENT
 FFC2 :GSINIT - initialise OS string input routine
 FFC5 :BSREAD - read character from input string
 FFCB :NVNRCH - non-vectorized character output
 FFCB :NVRDCH - non-vectorized character input
 FFCE :OSFIND - open or close a file
 FFD1 :OS6BPPB - transfer block to or from file
 FFD4 :OSBPUT - save a byte to file
 FFD7 :OSBGET - read a byte from file
 FFDA :OSARGS - read or write file arguments
 FFD0 :OSFILE - read or write whole file or attributes
 FFE0 :OSRDCH - read character from input
 FFE3 :OSASCI - output ASCII character
 FFE7 :OSNEWL - start new line
 FFE8 :OSNRCH - output character
 FFF1 :OSWORD - execute OS routine utilising parameter block
 FFF4 :OSBYTE - execute OS call
 FFF7 :OSCLI - execute command input string

6502 vectors.

FFFA : (0000) NMI vector
 FFFC : (D9CD) RESET vector
 FFFE : (DC1C) IRQ vector



Suddenly, quality plotting is within reach of every computer user...

Penman is an entirely new concept in plotting.

It is robotic, working almost like the human hand to draw smooth curves, perfect circles and dead straight lines... without staircases.

Penman is simple, reliable, very compact and truly portable; yet can plot on any size paper, on any smooth horizontal surface.

Use Penman at work, at home and at school... as a printer, robot, mouse and desktop plotter for BASIC and logo. Use it for design, or to produce graphs from spread-

sheets, scribe captions and notices. The only limit is your imagination.

For less than £300, Penman brings quality plotting to every computer user.

PENMAN

Penman Products Limited
 8 Hazelwood Close, Dominion Way,
 Worthing, W. Sussex BN14 8NP.
 Tel: (0903) 209081 Telex: 946250



At long last, the end of the queue is in sight.

MultiNet—the Gemini low cost network system, provides up to 31 work stations supported by a single file server.

With a track record of proven reliability the Gemini MultiNet CP/M system is ideally suited for wide ranging industrial, commercial, educational and professional applications.

For as little as
£750 per workstation—
(EXC VAT) why queue?



Gemini Microcomputers



Gemini Microcomputers Ltd., 18 Woodside Road, Amersham, Bucks, England HP6 0BH. Tel: (02403) 28321. Telex: 837788



Dataproducts' Paper Tiger=economy+flexibility+colour

With the introduction of the Paper Tiger range, Dataproducts make mainframe/mini printing standards available to business micro users. Each model is highly reliable, compact and compatible with almost all micros, including the IBM-PC. Gone are those awkward dip switches: all parameters are now set via a soft key front panel.

The 8010 operates at 180 cps for DP work, 90 cps for BP work and 30 cps for word processing (NLQ).

Business graphics, spreadsheets and even sophisticated CAD/CAM applications can be handled. The 8020 provides the same flexibility, with the advantage of a wider (13.2 inch against 8 inch) print line.

The 8050 adds higher performance, further improved graphics resolution and exceptional full colour printing. DP output increases to 200 cps, with BP and WP performance at 110 cps and 35 cps respectively. The 'top of line' 8070 gives all these features—plus an impressive 400 cps for DP output.

For full details on the complete Dataproducts range, talk to Teleprinter Equipment, one of the UK's largest distributors of computer peripherals. Phone Tring (0442 82) 4011.

All products are backed by TE Datacare, the company's own nationwide customer support and service organisation.



Teleprinter Equipment Ltd.

64-82 Akeman Street, Tring, Herts. HP23 6AJ. Telephone: Tring (0442 82) 4011/5551
Telex: 82362 BATECO G Cables: RAHNO TRING.

Regional Sales and Service: Manchester, Unit 5, Fivefold Industrial Park, Manchester Street, Oldham, OL9 6TP. Manchester (061) 626 3371

Associated Companies: General Audio and Data Communications Ltd. Communication Accessories and Equipment Ltd. Morse Equipment Ltd. Teleprinter Rentals Ltd. Datacare—a division of Teleprinter Equipment Ltd. Parent Company: William Batey & Co (Exports) Ltd. (Founded 1946).

Rising pitch

```

10 REM
20 REM "Climbing Man"
30 REM
40 REM by James Allwright
50 REM
60 REM
70 REM With Acknowledgements to
80 REM
90 REM The Royal Institution
100 REM
110 REM Christmas Lectures for t
he
120 REM
130 REM original demonstration.
140 REM
150 ON ERROR VDU4:ON ERROR OFF:END
160 DIMMX(35),MY(35),MN(35)
170 DISP=40:D=3000:SF=130:VX=D+6*S
F:VY=4000
180 SS=VY*2*SF/(16*D+70*SF):UD=30
190 VDU23,224,0,0,6,&F,&1F,&1F,&1F
,&C
200 VDU23,225,4,&C,&1E,&3E,&7F,&DF
,&9F,&8F
210 VDU23,226,&FF,&FE,&7E,&7E,&7E,
&FB,&F0,&E0
220 VDU23,227,0,0,0,1,3,3,7,&F
230 VDU23,228,&FF,&FF,&C1,&C0,&80,
0,0,0
240 VDU23,229,0,&80,&80,&C0,&66,&3
E,&1C,&18
250 VDU23,230,&E,&1C,&18,&30,&60,&
C0,&F0,&F0
260 VDU23,231,&F8,&FC,&CE,&C7,&C3,
&C1,&C0,&C1
270 VDU23,232,0,0,0,0,&80,&C0,&C0,
&C0
280 VDU23,233,&C7,&CC,&CC,&CE,&C6,
&C0,&F0,&F0
290 VDU23,234,0,0,0,18,&3C,&7E,&3
C,&18
300 VDU23,235,0,0,0,1,3,7,6,6
310 VDU23,236,&7E,&FF,&FF,&FF,&7E,
&7E,&7E,&7E
320 VDU23,237,0,0,0,&80,&C0,&E0,&6
0,&60
330 VDU23,238,4,4,6,2,2,0,0,0
340 VDU23,239,&7E,&7E,&7E,&7E,&7E,
&7E,&7E
350 VDU23,241,&7E,&66,&66,&66,&66,
&C6,&C6,&66
360 VDU23,242,6,6,6,6,6,6,6,6
370 VDU23,243,&7E,&66,&66,&66,&66,
&63,&63,&66
380 VDU23,244,&60,&60,&60,&60,&60,
&60,&60,&60
390 VDU23,245,0,0,&60,&F0,&F8,&F8,
&F8,&30
400 VDU23,246,&20,&30,&78,&7C,&FE,
&FB,&F9,&FD
410 VDU23,247,&FF,&7F,&7E,&7E,&7E,
&1F,&F,7
420 VDU23,248,0,0,0,&80,&C0,&C0,&E
0,&F0
430 VDU23,249,&FF,&FF,&83,3,1,0,0,
0
440 VDU23,250,0,1,1,3,&66,&7C,&38,
&18
450 VDU23,251,&70,&38,&18,&C,6,3,&
F,&F
460 VDU23,252,&1F,&3F,&77,&E3,&C3,
&83,3,&83
470 VDU23,253,0,0,0,0,1,3,3,3
480 VDU23,254,&E3,&33,&33,&73,&63,
3,&F,&F
490 MODE1
500 MOVEDISP,0:DRAWDISP,DISP
510 PROCMV(SF,0,5*SF):PROCMV(SF,0,
SF)
520 PLOT85,FNX(SF,5*SF),FNY(0,SF)
530 MOVEFNX(6*SF,4*SF),0:MOVEFNX(6
*SF,0),0
540 PROCTRI(6*SF,8*SS,4*SF):PROCTR
I(6*SF,8*SS,0)
550 X=5*SF
560 FORA=0T02:Z=A*SF:Y=(5+A)*SS
570 PROCQUAD(X,Y,Z,X+SF,Y,Z,X+SF,Y
,Z+SF,0)
580 PROCQUAD(X,Y,Z+SF,X+SF,Y,Z+SF,
X+SF,Y+SS,Z+SF,0)
590 NEXT
600 Z=3*SF
610 FORA=0T02:X=(5-A)*SF:Y=(8+A)*S
S
620 PROCQUAD(X,Y,Z,X+SF,Y,Z,X+SF,Y
,Z+SF,0)
630 PROCQUAD(X,Y,Z,X,Y,Z+SF,X,Y+SS
,Z+SF,3)
640 NEXT
650 X=0
660 FORA=5T01STEP-1:Y=-A*SS:Z=A*SF
670 PROCQUAD(X,Y,Z,X+SF,Y,Z,X+SF,Y
,Z+SF,0)
680 IFA<>5 PROCMV(X+SF,Y,Z):PROCMV
(X+SF,Y,Z+SF):PROCTRI(X+SF,Y-SS,Z+SF
)
690 NEXT
700 Z=0
710 FORA=0T05:X=SF*A:Y=A*SS
720 PROCQUAD(X,Y,Z,X+SF,Y,Z,X+SF,Y
,Z+SF,0)
730 IFA<>5PROCMV(X+SF,Y+SS,Z):PROC
MV(X+SF,Y,Z):GCOL0,0:PROCTRI(X+2*SF,
Y+SS,Z):GCOL0,3:PROCMV(X+SF,Y+SS,Z):
PROCDW(X+SF,Y,Z)
740 NEXT
750 FORA=0T010:MN(A)=A MOD2
760 MX(A)=FNX((A DIV2+0.5)*SF,SF/2
)
770 MY(A)=FNY((A DIV2)*SS,SF/2)
780 NEXT
790 FORA=11T017:MN(A)=2+A MOD2
800 MX(A)=FNX(5.5*SF,SF*(A-10)/2)
810 MY(A)=FNY(((A-1)DIV2)*SS,SF*(A
-10)/2)
820 NEXT
830 FORA=18T024:MN(A)=4+A MOD2
840 MX(A)=FNX((29-A)DIV2*SF+SF/2,3
.5*SF)
850 MY(A)=FNY(((A-2)DIV2)*SS,3.5*S
F)
860 NEXT
870 FORA=25T035:MN(A)=2+A MOD2
880 MX(A)=FNX(SF/2,((35-A)/2)*SF+S
F/2)
890 MY(A)=FNY(-(35-A)DIV2)*SS,((3
5-A)/2)*SF+SF/2)
900 NEXT
910 GCOL3,1:VDU19,1,2,0,0,0:VDU19,
2,2,0,0,0:VDU5
920 A%=0:N%=0
930 REPEAT
940 PROCMAN(MN(A%),MX(A%),MY(A%))
950 IF(A%MOD2)<>0SOUND0,0,0,UD/2:G
0T01000

```

TWO ILLUSIONS, one visual and one audible, are combined in James Allwright's cunning program. A man walks up a closed uphill staircase to the sound of notes which appear to be constantly rising in pitch.

The staircase was originally drawn by M C Escher. It is a three-dimensional projection drawing for which some parameters are:

D — distance of observer from screen

SF — scale factor

VY and SF — constants which can be chosen fairly arbitrarily

SS — step size

VX — constant which must be adjusted to make the illusion work.

The UD at line 180 is the delay time. If you cannot tell what is going on you may reduce this but the author suggests that you do so only as a last resort.

```

960 SOUND&300,0,0,UD/2:N%=(N%+1)MO
D36
970 SOUND&301,INT(ABS(18-N%)*5/6)-
15,53+4*N%,UD
980 T%=(N%+12)MOD36:SOUND&302,INT(
ABS(18-T%)*5/6)-15,53+4*T%,UD
990 T%=(N%+24)MOD36:SOUND&303,INT(
ABS(18-T%)*5/6)-15,53+4*T%,UD
1000 PROCMAN(MN(A%),MX(A%),MY(A%)):
A%=(A%+1)MOD36
1010 UNTILO
1020 END
1030 DEFPROCQUAD(X1,Y1,Z1,X2,Y2,Z2,
X3,Y3,Z3,C)
1040 X4=X1+X2-X3:Y4=Y1+Y3-Y2:Z4=Z1+
Z3-Z2
1050 GCOL0,C
1060 PROCMV(X2,Y2,Z2):PROCMV(X1,Y1,
Z1)
1070 PROCTRI(X3,Y3,Z3):PROCTRI(X4,Y
4,Z4)
1080 GCOL0,3-C
1090 PROCMV(X1,Y1,Z1):PROCDW(X2,Y2,
Z2)
1100 PROCDW(X3,Y3,Z3):PROCDW(X4,Y4,
Z4)
1110 PROCDW(X1,Y1,Z1)
1120 DEFPROC
1130 DEFPROCMV(X,Y,Z):MOVEFNX(X,Z),
FNY(Y,Z)
1140 ENDPROC
1150 DEFPROCQD(X,Y,Z):DRAWFNX(X,Z),
FNY(Y,Z)
1160 ENDPROC
1170 DEFPROCTRI(X,Y,Z):PLOT85,FNX(X
,Z),FNY(Y,Z)
1180 ENDPROC
1190 DEFFNX(X,Z)=DISP+VX+D*(X-VX)/(
D+Z)
1200 DEFFNY(Y,Z)=DISP+VY+D*(Y-VY)/(
D+Z)
1210 DEFPROCMAN(A,X,Y)
1220 ON A+1 GOSUB1240,1270,1300,133
0,1360,1390
1230 ENDPROC

```

```
1240 MOVEX,Y+5*32
1250 VDU224,10,8,225,8,10,226,8,10,
231,232,8,8,10,233
1260 RETURN
1270 MOVEX+4,Y+5*32
1280 VDU9,224,10,8,225,8,10,226,8,8,
10,227,228,229,8,8,8,10,230
1290 RETURN
```

```
1300 MOVEX-4*4,Y+5*32
1310 VDU234,10,8,235,236,237,8,8,
8,10,238,239,240,8,8,10,241,8,10,242
1320 RETURN
1330 MOVEX-7*4,Y+5*32
1340 VDU234,10,8,235,236,237,8,8,
8,10,238,239,240,8,8,10,243,8,10,244
1350 RETURN
```

```
1360 MOVEX,Y+5*32
1370 VDU245,10,8,246,10,8,247,10,8,
8,253,252,8,10,254
1380 RETURN
1390 MOVEX-9*4,Y+5*32
1400 VDU245,10,8,246,10,8,247,10,8,
8,250,249,248,10,8,251
1410 RETURN
```

Normal probabilities.

```
10 REM NORMAL DISTRIBUTION PROGRA
M
20 REM COPYRIGHT (c)C DUNNE 1984
30 REM VERSION 1.12 - REQUIRES OS
1.2
40 *FX16
50 REM GIVES 1.25% SPEED INCREASE
ON A MODEL B MACHINE
60 ONERRORREPORT:PRINT:VDU7:IFERR
<>17RUN:ELSEEND
70 DIMB$(4):B$(0)="from -"+CHR$(22
7+CHR$(228)+" to x":B$(1)="from -x t
o x":B$(2)="from 0 to x":B$(3)="
from x to "+CHR$(227)+CHR$(228):B$(4)
="from x to y"
80 *TV255,1
90 MODE1
100 *FX9,2
110 *FX10,2
120 VDU19,1,9,0,0,0,23,224,&1E,&30
,&30,&7C,&60,&60,&3C,0,23,225,3,3,6,
6,&6C,&3C,&18,0,23,226,&70,&3E,&37,&
36,&36,&36,&63,0,23,227,0,0,&1E,&33,
&33,&33,&1E,0,23,228,0,0,&F0,&98,&98
,&98,&F0,0
130 CLS:COLOUR1:PRINTTAB(5)"C.D. N
ORMAL DISTRIBUTION V1.12":COLOUR3
140 INPUT"DO YOU REQUIRE INSTRUCTI
ONS (Y/N)",A$
150 ONINSTR("YNyn",A$)GOTO160,170,
160,170ELSE140
160 PROCinstruct
170 VDU26,19,1,2;0;19,2,4;0;19,3,6
;0;
180 x=FNGET("x")
190 CLS:PRINTTAB(18)"MENU:"
200 FORA%=0TO4
210 PRINT";" ";A%+1;" : Evaluate P
";B$(A%)
220 NEXT
230 PRINT""Select:";
240 G%=GET-48:IFG%<10RG%>5THEN240
250 y=-3:xP=x
260 IFG%=1:y=x:x=-3
270 IFG%=2:y=x:x=-x
280 IFG%=3:y=x:x=0
290 IFG%=4:y=3
300 IFG%=5:y=FNGET("y")
310 Ax=x:IFABSAX>2.85:Ax=2.85*SGNA
x
320 Ay=y:IFABSAy>2.85:Ay=2.85*SGNA
y
330 CLS:PROCnormalgraph
340 VDU28,0,31,39,19:PRINT"Z(x) pl
otted against x for |x|< 4":VDU28,0,
31,39,21
350 PRINT"Evaluating the shaded (b
lue) area:"
360 PROCfill_area(Ax,Ay)
370 VDU28,0,31,39,23
380 x=xP
390 PRINT"x=";x;"", "Z(x)=";FNZ(x)
400 IFG%=5PRINT"y=";y;"", "Z(y)=";F
NZ(y) ELSEPRINT
410 PRINT"P(x)=";
420 IFG%=1 P=1-FNQ(x)
430 IFG%=2 P=1-2*FNQ(x)
```

```
440 IFG%=3 P=1/2-FNQ(x)
450 IFG%=4 P=FNQ(x)
460 IFG%=5 P=FNQ(x)-FNQ(y)
470 PRINT;ABSP;" ";B$(G%-1)
480 COLOUR1:PRINT""Press any key
";:COLOUR3
490 *FX15,1
500 A%=GET
510 GOTO170
520 DEFPROCnormalgraph
530 MOVE0,500:DRAW1279,500
540 FORA%=160TO1279STEP160:MOVEA%,
500:DRAWA%,480:VDU5:MOVEA%-16+16*(A
%/160-4)<0,472:PRINT;A%/160-4:VDU4:
NEXT
550 FORA%=0TO1279STEP16
560 X=(A%-640)/160
570 Z=FNZ(X)
580 B%=500+Z*1200
590 IFA%=0 MOVEA%,B% ELSEDRAWA%,B%
600 NEXT
610 ENDPROC
620 DEFPROCfill_area(x,y)
630 GCOLOR,2
640 MOVE640+x*160,504:DRAW640+x*160
OSC(IOSCLI496+1200*FNZ(x)
650 MOVE640+y*160,504:DRAW640+y*160
0,496+1200*FNZ(y)
660 IFx=y THEN680
670 IFx<y PROCFILL(644+x*160,504,2
) ELSEPROCFILL(636+x*160,504,2)
680 GCOLOR,3:MOVE640,500:PLOT21,640
,1023
690 ENDPROC
700 DEFFNQ(X)
710 IFX<0 =1-FNQ(-X)
720 LOCAL F,T
730 T=1/(1+.2316419*X)
740 F=.31938153*T-.356563782*T^2+1
.781477937*T^3-1.821255978*T^4+1.330
274429*T^5
750 ABS(FNZ(X)*F)
760 DEFFNZ(X)=EXP(-X*X/2)/SQR(2*PI
)
770 DEFPROCHow_its_done
780 CLS:PRINT"P(x) is calculated a
s follows:"
790 COLOUR2:PRINTTAB(7)"P(x)=1-Q(x)
" where""TAB(17)"2 3 4 5
""Q(x)=Z(x)(b t+b t +b t +b t
)+(x)""TAB(11)"1 2 3 4 5
""
800 PRINTTAB(24)"2""TAB(7)"Z(x)=1/
";CHR$(129);"2";CHR$(130);" exp(-x /2)""
810 PRINT"b =0.31938153""TAB(24)"b
=-0.356563782"" 1""TAB(25)"2""b =1
.781477937""TAB(24)"b =-1.821255978""
" 3""TAB(25)"4""b =1.330274429"" 5
""
820 PRINT"t=1/(1+px) where p=0.2
316419":COLOUR3:PRINT"The absolute
error,";COLOUR2:PRINTTAB(26)"-8""TAB
(12)""|";CHR$(128);"(x)|< 7.5x10":COLO
UR1
830 PRINT"" Reference:";:COLOUR3
:PRINT"Handbook of Mathematical""
Functions, Abramowitz and Stegun,""
National Bureau of Standards, 1964
."
"
```

Normal probabilities

Probabilities and confidence limits based on a normal distribution are calculated by C Dunne. The results are plotted graphically to help eliminate operator error. The block-fill routine included in the source may be extracted and used elsewhere. The program runs on a menu and contains copious instructions — you can leave most of them out if you don't fancy typing it all in.

```
840 COLOUR2:PRINT""Press any key";:
COLOUR3
850 A%=GET
860 ENDPROC
870 DEFPROCinstruct
880 CLS:PRINT"" This program will
enable you to""calculate values of
Z(x) and P(x) for""any x."
890 PRINT"" When prompted 'x:',
do one of two""things. Either:"""(
a) enter a value for x, or""(b) ju
st hit 'RETURN'."
900 PRINT"" In case (b), the pro
gram will ask""for values of m, mba
r and sigma, and""will then evaluat
e the expression:"":COLOUR2:PRINTTAB
(10)"x=(m - mbar)/sigma":COLOUR3:PRI
NT""i.e. it will save you having to
work!"
910 PRINT"out x for yourself (lazy
!)."
920 PRINT"" Once the program has
got x, you can""get Z(x) or P(x).
The limits for Z over""which P is e
valuated may be chosen from""the 'M
ENU' you will be offered."
930 PRINT""At any time, press 'ESC
APE' to abort."
940 PRINT"" Do you want to see t
he clever way""P(x) is evaluated? I
f so, type 'H' (for""Help), otherwi
se hit 'RETURN'."
950 INPUT:"A$
960 IFA$="H"ORAS$="h" PROCHow_its_d
one
970 ENDPROC
980 DEFFNQ(AS)
990 LOCAL X
1000 CLS:PRINTA$;
1010 INPUT:"B$
1020 IFB$=""THEN1030 ELSE=EVAL(B$)
1030 INPUT"" m : "m
1040 INPUT"" mbar : "mbar
1050 INPUT"" sigma : "sigma
1060 x=(m-mbar)/sigma
1070 PRINT""A$;"=";"x'"
1080 INPUT"OK",B$
1090 ONINSTR("YNyn",B$)GOTO1100,103
0,1100,1030ELSE1080
```

(continued on next page)

(continued from previous page)

```

1100 =x
1110 DEFPROC FILL(X,Y,C) LOCAL V:DIMP
ARAM 7:AX=135:V=(USR(&FFF4)DIV&1000
0)AND15)-1:IFV=7ORV=6ORV=3 ENDPROC
1120 W=2*(V MOD3+1):Z=2*W:V=POINT(X
,Y):IFC=V:ENDPROC ELSE GCOLO,C:GCOLO,
V+128
1130 PROCUD(X,Y,4):PROCUD(X,Y,-4):E
NDPROC
1140 DEFPROCUD(X,Y,S) LOCAL FX,B%,CX
,D%,EX: PLOT76,X,Y:B%=FNC(4):C%=FNC(0
)
1150 PLOT77,X,Y
1160 Y=Y+S:D%=FNC(4):E%=FNC(0):IFE%

```

```

-C%<Z THEN1200
1170 FX=CX
1180 FX=FX+W:IFPOINT(FX,Y-S)=V PROC
UD(FX,Y-S,S)
1190 IFFX<EX THEN1180
1200 IFB%-DX<Z THEN1250
1210 FX=DX
1220 FX=FX+W
1230 IFPOINT(FX,Y-S)=V PROCUD(FX,Y-
S,S)
1240 IFFX<BX THEN1220
1250 IFC%-EX<Z THEN1290
1260 FX=EX
1270 FX=FX+W:IFPOINT(FX,Y-2*S)=V PR
OCUD(FX,Y-2*S,-S)

```

```

1280 IFFX<CX THEN1270
1290 IFDX-BX<Z THEN1330
1300 FX=BX
1310 FX=FX+W:IFPOINT(FX,Y-2*S)=V PR
OCUD(FX,Y-2*S,-S)
1320 IFFX<DX THEN1310
1330 BX=DX:CX=EX:IFPOINT(X,Y)=V THE
N1150
1340 IFPOINT(X,Y)=-1 ENDPROC
1350 FX=EX:REPEAT:FX=FX+W:UNTILFX>D
%ORPOINT(FX,Y)=V:IFFX>DX ENDPROC
1360 X=FX:GOTO1150
1370 DEFFNC(ZX):AX=13:XX=PARAM MOD2
56:YX=PARAM DIV256:CALL&FFF1:=(PARAM
!ZX)AND&FFFF

```

Engineering notation.

```

10 REM PenGDB des fisher harLo
w(O279) 22450 1983
20
30 REM Demonstrates PROCenG
40
50 MODE 7
60 PRINT"PenGDB";TAB(23);"des
fisher 1983"
70 PRINT"This program demonstra
tes PROCenG. It"
80 PRINT"converts its argument,
num, into"
90 PRINT"engineering notation."
100 PRINT"Engineering notation i
s when the"
110 PRINT"exponent is always a mu
ltiple of three."
120 PRINT"PROCenG returns the st
ring n$ which"
130 PRINT"has a maximum length se
t by field%."
140
150 REPEAT
160 INPUT"Input your value",x
)
170 PROCenG(x)
180 PRINT"In engineering notat
ion ";x;" ="
190 PRINTTAB((40-LEN(n$))/2);n
$

```

```

200 UNTIL FALSE
210
220
230 REM Converts num to n$ in engi
neering notation
240 REM exponential power availabl
e as exp%
250 REM mantissa available as L$
260 DEF PROCenG(num)
270 LOCAL field%,n,An,Ln
280 field%=7:REM Max display cha
racters
290 exp%=0:L$=""
300 n=ABS(num):An=n
310 IF n=0 THEN n$="0":ENDPROC
320 Ln=LOG(n)
330 exp%=INT(LOG(n)/3)*3
340 n=num/(10^exp%)
350 n$="E"+STR$(exp%)
360 IF An<1E3 AND An>=1 THEN n
$=""
370 field%=field%-LEN(n$)
380 IF field%<LEN(STR$(INT(n)))
) THEN PRINT"Field too small":ENDPR
OC
390 L$=LEFT$(STR$(n),field%)
400 IF RIGHT$(L$,1)="#" THEN
L$=LEFT$(L$,LEN(L$)-1)
410 n$=L$+n$
420 ENDPROC

```

Snow scene.

```

10 *TV 0,1
20 MODE 2
30 VDU 5
40 FOR CX=8 TO 11:VDU 19,CX,4,0,
0,0:NEXT CX
50 FOR CX=12 TO 15:VDU 19,CX,2,0
,0,0:NEXT CX
60 CX=11
70 FOR IX=0 TO 640 STEP 16
80 J%=608+IX/4
90 PROCskyhill(4,608+IX/4,1023,1
023,4,8)
100 NEXT IX
110 CX=12
120 FOR IX=640 TO 1279 STEP 16
130 J%=936-IX/4
140 PROCskyhill(4,936-IX/4,1023,1
023,4,8)
150 NEXT IX
160 CX=16
170 FOR IX=0 TO 640 STEP 16
180 J%=0
190 PROCskyhill(2,0,608+IX/4-52,6
08+(IX+8)/4,4,12)
200 NEXT IX
210 CX=16

```

```

220 FOR IX=656 TO 1280 STEP 16
230 J%=0
240 PROCskyhill(2,0,936-IX/4-52,9
36-IX/4,4,12)
250 NEXT IX
260 T=30:H=120
270 FOR N=1 TO 30
280 GCOL 0,1
290 X=RND(1200):Y=RND(608)
300 MOVE X,Y:DRAW X+T,Y+H
310 PLOT 85,X+2*T,Y
320 NEXT N
330 CX=8:B%=11:VX=700:W%=640
340 REPEAT
350 VDU 19,CX,4,0,0,0
360 CX=CX+1+4*(CX=11)
370 VDU 19,CX,7,0,0,0
380 A=INKEY(5)
390 VDU 19,BX,2,0,0,0
400 BX=BX+1+4*(BX=15)
410 VDU 19,BX,7,0,0,0
420 A=INKEY(5)
430 XX=RND(1279)
440 REPEAT
450 YX=RND(936)
460 UNTIL POINT(X%,Y%)<4 OR POINT

```

Engineering notation

Des Fisher's little routine, ProcEng, takes any number and generates a string which expresses it in engineering notation

Engineers who regularly have to deal with very large and very small numbers use a system similar to the exponential convention used in Basic. The difference is that engineers find it convenient to round the exponent — the part that represents the number of powers of 10 — to a multiple of three. So Basic's 15E2 becomes 1.5E3 or 1.5x10³.

Though any number can be sent to ProcEng, the variable Field % can be used to set the maximum character count in n\$. Inevitably there is some loss of accuracy when some significant figures are lost.

Snow scene

A wintry graphics demonstration program comes from P A Watmough. The snowflake effect is achieved by redefining four of the flashing colours to be blue and the other four to be green. The blue ones are then embedded in the sky and the green ones in the hill.

To give the impression of snow falling, the embedded spots are redefined to white for a moment, then returned to the background colour. If this is done in an ordered sequence, the impression of moving down can be obtained.

```

(X%,Y%)=7
470 GCOL 0,7:PLOT 69,X%,Y%
480 UNTIL FALSE
490 DEF PROCskyhill(D%,EX,FX,G%,U
%,V%)
500 REPEAT
510 MOVE IX,J%
520 GCOL 0,D%
530 R%=RND(12)
540 DRAW IX,J%+R%*4
550 CX=CX-1-U%*(CX=V%)
560 GCOL 0,C%
570 PLOT 69,IX,J%+R%*4+8
580 J%=J%+R%*4+8
590 UNTIL J%>=FX
600 GCOL 0,D%
610 IF D%=2 DRAW IX,G%
620 MOVE IX+8,EX:DRAW IX+8,G%
630 ENDPROC

```

After we sell you a system we store you in our memory.

At Oryx we offer the most comprehensive and competitively priced range of micro computer hardware, software and accessories to business and the businessman.

We also offer expert advice, which is both free and plentiful.

And, perhaps most importantly, you can buy from us with complete confidence. Any system or package you purchase from us, you've the assurance of our unrivalled, full after-sales support and our technical hot-line.

Because even after we sell you a system we won't forget to look after you.



ORYX SYSTEMS

It's our business to help yours.

CP/M SOFTWARE

ABTEX SOFTWARE	
Pertmaster*	£625
ASHTON TATE	
DBase II*	£295
COMSOFT	
Compsort DMS*	£180
DMS Delta*	£450
DIGITAL RESEARCH	
Access Manager	£215
Access Manager-86*	£280
Display Manager	£285
Display Manager-86*	£355
Pascal MT+	£435
Pascal MT+86	£465
FOX & GELLER	
dGraph*	£160
dUtil*	£60
MICROPRO	
Calcstar*	£95
Infostar*	£338
Mailmerge*	£120
WordStar*	£205
WordStar Professional*	£290
MICROSOFT	
Basic Compiler*	£275
Basic Interpreter*	£259
Fortran Compiler	£405
Macro Assembler	£155
Multiplan*	£150
SORCIM	
Supercalc*	£105
Supercalc 2*	£165
SAGESOFT	
Sage Accounting*	£350
Sage Executive*	£645

Most machine formats available.

SOFTWARE FOR IBM/PC

Please see CP/M listing. All product with an * will also run on MS-DOS and PC-DOS and are priced the same

ALPHA SOFTWARE	
Database Manager II	£190
ASHTON TATE	
dBase III	£415
Framework	£415
BORLAND INTERNATIONAL	
Sidekick	£49
Turbo Pascal	£49
DIGITAL RESEARCH	
Concurrent CP/M-86	£250
CP/M-86+GSX	£47
DR Draw	£225
DR Graph	£150
Pascal MT+	£435
INNOVATIVE SOFTWARE	
Smart Integrated System	£625
IMSI	
4-Point Graphics	£155
IUS	
Easy Writer II System	£260
LIFETREE	
VolksWriter Deluxe	£235
LOTUS	
Lotus 123	£350
Symphony	£495
MICRORIM	
R:Base 4000	£325
MICROPRO	
WordStar 2000	£400

MICROSOFT

Fortran Compiler	£255
Flight Simulator	£45
Word	£325
Macro Assembler	£90
Word+Mouse	£415
Microsoft Chart	£235
Microsoft Project	£235
PETER NORTON COMPUTING	
Norton Utilities 2.0	£69
SPI	
Open Access	£400
SOFTWARE PUBLISHING	
PFS:File	£99
PFS:Graph	£99
PFS:Report	£95
PFS:Write	£99
SOFTWORD SYSTEMS	
Multimate	£335
SORCIM	
Supercalc III	£255

BOARDS FOR IBM/PC

AST RESEARCH	
Mega Plus 64K	£295
Mega Pack 256K	£355
Six Pack Plus 64K	£295
Six Pack Plus 384K	£645
64K Chip Kit	£78
HERCULES	
Colour Card	£210
Graphic Card	£375
QUADRAM	
Quadboard II 64K	£295
Quadboard II 256K	£495
Expanded Quadboard 384K	£565

PRINTERS

BROTHER HR15	£425
BROTHER HR25	£725
CANON 1080A	£319
DATA PRODUCTS 8020	£565
DATA PRODUCTS 8050	£1445
EPSON FX-80	£379
EPSON FX-100	£529
JUKI 6100	£359
MT 80	£200
SMITH-CORONA D200	£420
TEC 1550	£525

HARDWARE

We recommend and put together systems based on Columbia, Televideo and Zenith PC's.

HOW TO ORDER

Simply telephone 01-636 0476 to discuss your purchasing requirements. Visitors at our London office - just off Oxford Street - are very welcome. Orders will be acknowledged and goods are normally despatched within 10 days. All major credit cards accepted. Prices exclude VAT and are subject to change without notice.

TECHNICAL HOTLINE

Or ring 01-631 4341 without obligation for advice.

EXAMPLE PRICE

64K PC	1139
Keyboard	185
Second Drive	297
Mono Adapter	181
Mono Display	186
DOS 2.1	59

Upgrade to 640K **FREE**

TOTAL COST £2047

Phone for YOUR configuration Quote

640K
Upgrade
Free
With IBM-PC, XT And Compaq Complete Systems

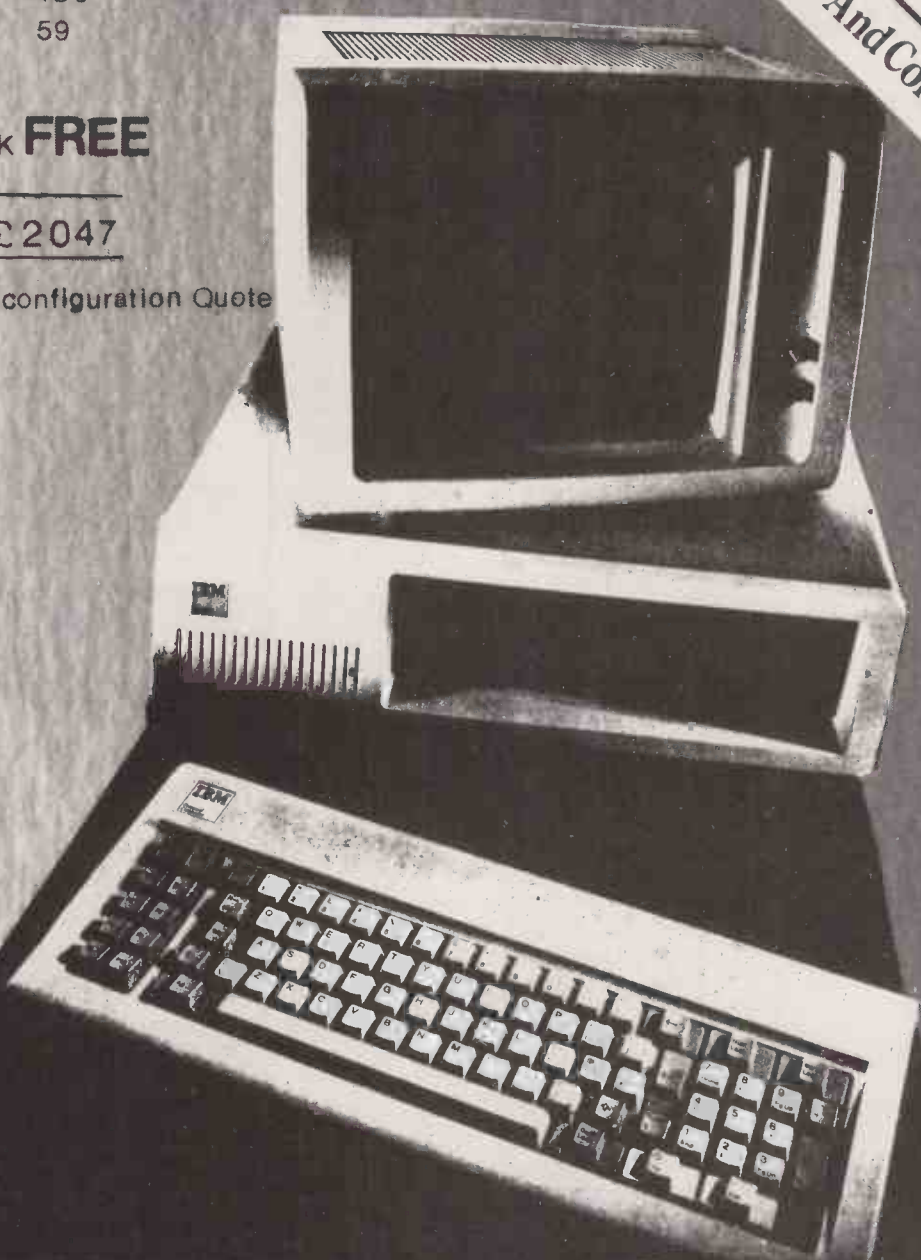

LIMITED OFFER!

Please Phone Your Nearest Branch

NORTH LONDON 637, HOLLOWAY ROAD LONDON N19 5SS 01 281 2431
SOUTH LONDON 67, WESTOW STREET, UPPER NORWOOD LONDON SE19 3RW 01-771 6373
MIDLANDS 14, CHARLES STREET, HANLEY STOKE-ON-TRENT ST1 3AR (0782) 269 883

MICROWARE



Date checker

MANY PROGRAMS invite the user to enter the date, and so require a validation test to check that they are legal. Many programmers will have a stock routine that does this, but it can be a tricky thing to write, and if not done economically takes up valuable program space.

James Garlick has provided a date-checking routine which is not easy to follow but only requires a single line of code. In the accompanying example, which I have constructed to show the routine in action, it is in line 100.

James Garlick splits the input into three variables D, M and Y. M is easy to test as it must be greater than 0 but less than 13.

Tests of D are usually cumbersome, he says, because of the apparently haphazard relationship between the number of the month and the number of days in it.

His solution is to construct a table. The first row, M, is the month number. The second row is produced by Anding M with 1, to obtain 1 when M is odd, and 0 otherwise. The third row, N, has 1 if there are 31 days in the month, and 0 otherwise.

The essence of the problem is then to derive N from M, which can be done by the relation

$$N = (M + (M > 7)) \text{AND} 1$$

For January to July, months 1 to 6, M > 7 is false and has the value 0. For August

onwards it is true and has the value -1; this is used to switch M from even to odd. The routine therefore checks that D is less than 31 + N, with a further subtraction for the second month, February.

Note the use of

$$(Y \text{ AND } 3) = 0$$

as a simple test of divisibility when the denominator is a pure power of two. Also note that the whole test assumes a Basic in which True has a value of -1. If you are converting for a Basic where True generates 1, the signs in front of

$$M = 2$$

and

$$(Y \text{ AND } 3)$$

must be changed

The test will be correct for the year 2000, which will be a leap year. It will fail for 2100, but James Garlick adds "any complaints at that time should be sent to the writer by air mail".

M	1	2	3	4	5	6	7	8	9	10	11	12
M And 1	1	0	1	0	1	0	1	0	1	0	1	0
N	1	0	1	0	1	0	1	1	0	1	0	1

Date checker.

```

10 PRINT "DATE: "; : INPUT D
20 PRINT "MONTH: "; : INPUT M
30 PRINT "YEAR: "; : INPUT Y
100 K=D*M*(M<13)*(D<31+((M+(M*7))AND 1)+(M=2)*(2+((Y AND 3)=0)))
120 IF K=0 THEN PRINT "THE DATE IS ILLEGAL"
130 GOTO 10

```

Function-key control

When using Basic on the IBM PC, the system provides a useful set of definitions for the function keys along the bottom of the screen. You can get rid of these by typing Key Off, or including it in a program, but this only removes them from the screen. If the user actually presses any of the function keys they still work, and this can be a problem.

Mike Curtis has provided a very small routine which clears the keys until Basic or Basica is reloaded — see lines 10 to 50 in the accompanying listing. The routine Peeks the memory addresses where the function keys are located and stores them in the array Mem(). This could be done by including these lines at the start of your program. Then, at the end of your program, use lines 9000 to 9020 to restore the values obtained in lines 20 to 50 and so reactivate the keys.

I have added five lines to Mike Curtis's listing to show how the idea works in practice. The screen is cleared while the Test routine in line 110 is run, then the program stops. To continue and restore the keys to their original functions, type Cont.

Function-key control.

```

10 DIM MEM(160)
20 FOR I=1619 TO 1778
30 MEM(I-1618)=PEEK(I)
40 POKE I,0
50 NEXT I
100 KEY OFF
110 FOR TEST=1 TO 20:PRINT "PC Rules OK":NEXT
120 KEY OFF:STOP
9000 FOR I=1619 TO 1778
9010 POKE I,MEM(I-1618)
9020 NEXT I
9030 KEY ON
9040 PRINT "Done"

```

Printing with WordStar

The current versions of WordStar do not support the double-width and compressed-print facilities available on the IBM PC Graphics Printer. However, it is possible to access these using the User Printer Controls described on page 7.3 of the WordStar manual. To use them you have to set up a patch so they become oper-

ative, and to do that you need to use Debug, IBM's answer to DDT.

Firstly, load the DOS disc into drive A and a copy of the WordStar system disc into drive B. Do not use the master copy supplied by Micropro. Type

```
DEBUG B:WS.COM
```

to load Debug and then WS.COM. The part that needs to be patched starts at 077F, and the relevant code is given on

(continued on next page)

(continued from previous page)

page 6 of User 4, Printer Patch area in appendix C of the WordStar Manual.

A screen prompt of

will be seen, indicating that Debug is ready for its next command. So type

D 0770

to Dump the section of WordStar you are interested in. The screen will display a block of hexadecimal numbers with the boundary address on the left and an ASCII portion on the right, as shown in figure 1.

You now need to enter the appropriate ASCII printer codes which control the turning on and off of the compressed and extended print modes. From the printer handbook these are found to be: Compressed mode On, 15; Compressed mode Off, 18; Extended mode On, 14; Extended mode Off, 20. The equivalent hex values, which are the ones you need to insert are 0F, 12, 0E and 14. You need to enter them into the correct locations, preceding each one by a single byte to tell WordStar how many bytes are in the following command. Since each of the commands is one byte long the flag byte is 01.

Accordingly, enter the following information into these locations

077F	01
0780	0F
0784	01
0785	12
0789	01
078A	0E
078E	01
078F	14

By typing E followed by the address the current contents of that location are displayed. The new contents are then entered. If required, the Enter key can be pressed after each entry.

An easier method is to press the space bar after an entry has been made. This advances the pointer to the next location whose contents are shown, and the procedure is then repeated. The Enter key then only needs to be pressed when that batch is completed. This was how the entries shown in figure 2 were made.

When all this is completed Dump the relevant part of the file to check that the new commands have been inserted correctly.

If all is well type W to Write the amended version back to the disc. Follow this by a Q to return to DOS.

The new facilities are invoked in the same way as the other printer control codes by typing Control-P followed by the relevant letter.

^P^Q turns compressed print on

^P^W turns it off

^P^E turns expanded print on

^P^R turns it off

The ^P^E command, unlike ^P^Q, is cancelled by a Carriage Return and has to be reinvoked at the beginning of the next line.

You may also find on printing that additional spaces are inserted into the text and the spacing will then have to be adjusted within WordStar. With compressed print it is possible to get round this by putting the ^P^Q on a blank line before the part you want compressed.

Once you are sure it works then you can Copy the amended version of WS.Com on to your other WordStar system discs. For safety, leave the master untouched. 

Example of compressed print on the IBM PC using Wordstar

Example of extended pr

WordStar printing.

Figure 1.

A>DEBUG B:WS.COM

-D 0770

0964:0770	00 00 00 00 00 00 00 00 00-00	00 00 00 00 00 00 00 00
0964:0780	00 00 00 00 00 00 00 00 00-00	00 00 00 00 00 00 00 00
0964:0790	00 00 00 00 00 00 00 00 00-00	00 00 00 00 00 00 00 00
0964:07A0	00 00 00 00 00 00 00 00 00-00	00 00 00 00 00 00 00 00
0964:07B0	00 00 00 00 00 00 00 00 00-00	00 00 00 00 00 00 00 00
0964:07C0	00 2D 5F 90 90 C3 90 90-C3	00 00 00 90 90 90 BA	.._..C..C.....
0964:07D0	00 00 B4 02 CD 17 80 E4-A0	75 01 F9 C3 90 90 90	..4.M..d u.yC...
0964:07E0	90 90 90 90 90 BA 00 00-B4	00 CD 17 C3 90 F9 C3:..4.M.C.yC

Figure 2.

-E 077F

0964:077F 00.01

0964:0780 00.0F

-E 0784

0964:0784 00.01 00.12

-E 0789

0964:0789 00.01 00.0E

-E 078E

0964:078E 00.01 00.14

-D 0770

0964:0770	00 00 00 00 00 00 00 00 00-00	00 00 00 00 00 00 00 01
0964:0780	0F 00 00 00 01 12 00 00-00	01 0E 00 00 00 01 14
0964:0790	00 00 00 00 00 00 00 00 00-00	00 00 00 00 00 00 00 00
0964:07A0	00 00 00 00 00 00 00 00 00-00	00 00 00 00 00 00 00 00
0964:07B0	00 00 00 00 00 00 00 00 00-00	00 00 00 00 00 00 00 00
0964:07C0	00 2D 5F 90 90 C3 90 90-C3	00 00 00 90 90 90 BA	.._..C..C.....
0964:07D0	00 00 B4 02 CD 17 80 E4-A0	75 01 F9 C3 90 90 90	..4.M..d u.yC...
0964:07E0	90 90 90 90 90 BA 00 00-B4	00 CD 17 C3 90 F9 C3:..4.M.C.yC

-W

Writing 5180 bytes

-Q

PICK UP THE PHONE FOR THE BEST PORTABLE PACKAGE.

(0280) 816087

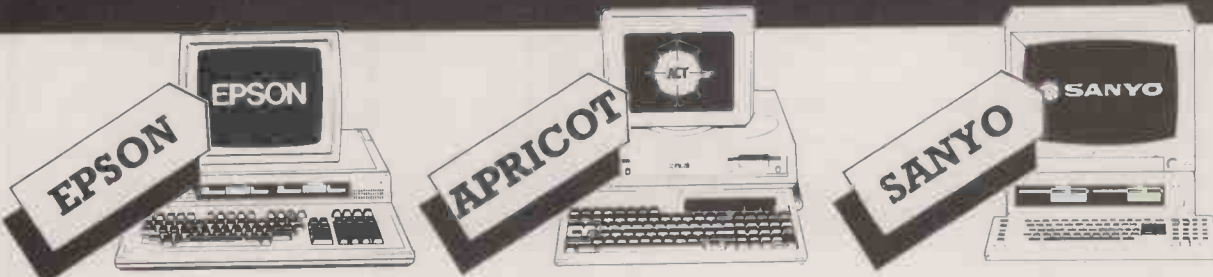

FREE SOFTWARE & TRAINING WITH EVERY SYSTEM.

Phone (0280) 816087 for more information.

- Impartial advice from trained consultants.
- On site training.
- On site servicing & fully equipped workshops.
- Complete After Sales telephone support.

Bristle Hill, Buckingham MK18 1EZ Telephone (0280) 816087



● Circle No.14



COMPUTER SYSTEMS AND SUPPLIES

Official Government/Educational/Local Authority orders welcome

COMPUTERS

SANYO and APRICOT, complete systems including WP, spreadsheet, database, SAGE accounts, printer, cables, disks & paper from... £1395

MONITORS

Philips CT2000 TV/monitor.....	£199
Kaga Taxan K12R1X colour.....	£179
Sanyo CD3125 colour.....	£159
Microtec 1431 colour.....	£179

MATRIX PRINTERS

Smith Corona Fastext 80.....	£159
Shinwa CPA80 100 CPS.....	£179
Centronics G1P 50cps NLO - NEW.....	£199
Panasonic KXP1091 NLO.....	£269
Kaga Taxan K810 NLO.....	£269
Canon PW100A NLO.....	£289
Smith Corona D200 NLO.....	£359
NEC P1 180 CPS.....	£349
HP Thinkjet 150 CPS.....	£385
Paper Tiger 8010 NLO.....	£409
NEC Printwise P2 NLO.....	£525
Brother 2024L NLO (at 96cps).....	£549
IBM printers.....	CALL

PRINTER BUFFERS

8K-£75	16K-£85	32K-£95	64K-£119	128K-£249
--------	---------	---------	----------	-----------

DAISYWHEEL PRINTERS

Daisy Junior 14 CPS.....	£199
Uchida/Daisyjet 18 CPS.....	£209
Juki 2230 10 CPS.....	£239
Brother HR15 20 CPS.....	£329
Juki 6300 40 CPS.....	£679
NEC Spinwriter 3500.....	£1039

PLOTTERS

SCP 900 A4 NEW.....	£169
Roland DXY101 A3.....	£275
Plix A4.....	£369
Hewlett Packard 7470.....	£789
Houston EDM42 A1.....	£2995

These represent only a small sample of our full range of computers and peripherals. Please telephone or write for full list.

DISK DRIVES

Cumana, Opus & Pace.....	from £95.
--------------------------	-----------

EXPANSION SYSTEMS For IBM, Apricot, etc., all at discount prices.

FLOPPY DISKS - LOWEST PRICES YET! - POST FREE

Per box of 10 — all double density	DYSAN 5.25" 100% guaranteed				3M 5.25" Lifetime guarantee			
	1	24	59	104	1	24	59	104
SS 48 TPI	17.00	16.50	18.00	15.50	14.50	14.00	13.50	13.00
DS 48 TPI	24.50	24.00	23.50	23.00	18.00	17.50	17.00	16.75
SS 96 TPI	24.50	24.00	23.50	23.00	21.00	20.50	20.00	19.50
DS 96 TPI	29.50	29.00	28.50	28.00	23.50	23.00	22.50	22.00

NASHUA 5.25" 5 year guarantee

SS 96 TPI	17.45	17.05	16.65	16.25	34.50	34.00	33.50	32.50
DS 96 TPI	18.95	18.55	18.15	17.75	45.50	45.00	44.00	42.50

Please add £2.00 to the above prices if required in 'SEE10' Library Case.

*DYSAN branded disks (boxed for other suppliers) - SPECIAL OFFER deduct £1.50 from these prices
FANFOLD PAPER Low prices across the range, e.g. 11" x 8 1/2" - £9.35. 11" x 9 1/2" - £9.75. A4 Clean Edge £11.69
Prices per box of 2000. Quantity discounts. All sizes available.

RIBBONS All types available at low prices, plus quantity discounts e.g. Smith-Corona TPI - £2.39. Brother EP44 - £1.69. Juki 6100 - 99p. Shinwa CP80 - £3.79. Epson FX100/RX - £2.49.

Please send cheque with order. Carriage: Disks POST FREE. Computers/Printers/Monitors/Disk Drives £7.50. Paper £2.25 (fixed) + £1 per box. Ribbons & Printwheels 95p (any quantity). Please add 15% VAT to all prices (inc. carriage). Limited space precludes listing of our full range of products. Please telephone if you do not see the item you require, or write for full list.

A.M.A. COMPUTER SYSTEMS & SUPPLIES
Dept. B, 8 Glebe St., Beeston
NOTTINGHAM NG9 1BZ. Tel. 0602 255415

● Circle No. 147

UP TO 40% Discount on PC Software & Accessories

Framework.....	£297.00	Symphony.....	£399.95
DBase II.....	£224.25	DBase III.....	£293.25
Friday.....	£126.05	LOTUS 123.....	£276.00
Wordstar.....	£194.35	Word w/o Mouse.....	£201.25

Quadboard from.....	£208.15	RAM cards from.....	£171.35
64K RAM Kits.....	£ 44.00	I/O Plus.....	£105.87

10 MByte Hard disk with controller only.....	£799.95
Cartridge Drive Backup with software.....	£799.95

This is only a small selection from our range - please ring for more details

10 M Hard Disk Computer from under £2500.00

The SAM 2001 is fully IBM XT compatible at a fraction of the cost. Look at these features: 8088 (16 bit) processor, optional 8087, up to 256K RAM on board, floppy drive, 10M hard disk, colour/graphics adaptor, keyboard, 130W PSU, IBM style case.

Circuit Board Design without the Tedium

smARTWORK lets you create and revise PCB artwork on your IBM. Requires 192K RAM, colour/graphics adaptor and Epson printer. Demo disk £10.00, smARTWORK software £895.00, complete systems from under £4,000.

Terms: CASH WITH ORDER. Add £5.00 for post and packing, all prices exclude VAT. Prices subject to change without notice.

CONGUIN SOFTWARE

Phone 0524 381423

14 GOODWOOD CLOSE, MORDEN, SURREY, SM4 5AW

● Circle No. 172

The British Computer Society VARIPLANNER

Printed in multi colour on 020 plastic sheets (24" x 35" approx) the Variplanner comes complete with a pack of six coloured drawing pens.

The British Computer Society Variplanner combines a universal planning facility with a trade buyers' guide, and carries a written twenty-year guarantee with each copy purchased.



To: The British Computer Society, 13 Mansfield Street London W1M 0BP

Please send me _____ copies of The British Computer Society Variplanner at £5.00 per copy (including post & packing) each.

I enclose my payment for £ _____

Name of company/firm _____

Address _____

Name of individual purchaser _____

Telephone no. _____



PC 4

● Circle No. 156

The British Computer Society Planner

Printed in multi colour on 020 plastic sheets (24" x 35" approx) the Year Planner comes complete with a pack containing coloured self adhesive stickers and a dry-wipe marker pen.

The British Computer Society Planner combines a perpetual planning facility with a comprehensive buyers' guide list, and carries a written twenty-year guarantee with each copy purchased.



To: The British Computer Society, 13 Mansfield Street London W1M 0BP

Please send me _____ copies of The British Computer Society Planner at £5.00 per copy (including post & packing) each. I enclose my payment for £ _____

Name of company/firm _____

Address _____

Name of individual purchaser _____

Telephone no. _____



PC 4

Basic screen dump

BASIC is too slow to be of much use for dumping the contents of the Amstrad screen to a printer, but F M Collins has written a fast machine-code program to do the job. Intended for the Mannesmann Tally MT-80 printer it also works successfully with the Shinwa CPA-80, but for other Epson-type printers slight modifications may be required.

A Basic loading program and assembler listing are supplied. Several NOPs are included in the assembler listing, both to serve as markers and to allow space for any additional control codes required.

The seven-line data bus of the 464's Centronics port has made life interesting and the 640-bit line length has had to be handled as 639 plus 1. Trying to divide the 400-line screen by 14 or 7 is not much easier, and this is taken as

$$28 \times 14 + 8$$

in the text mode and

$$57 \times 7 + 1$$

in graphics mode. The latter prints every bit of information twice, similar to the VDU display, and gives a more acceptable aspect ratio; it also takes twice as long.

Connect your printer, then enter and run the Basic loader. If you have entered the data correctly you will be prompted to enter G or T and the listing will reappear.

```

10 ' SCREEN DUMP LOADER (c) F.M.Collins 1985
15 MEMORY 43708:MODE 2:tot=0
20 FOR j=43709 TO 43900:READ n$
25 n=VAL("&"+n$):tot=tot+n
30 POKE j,n:NEXT
35 IF tot>23095 THEN PRINT "Checksum error - check data":LIST
40 DATA C5,E5,D5,F5,CD,2E,BD,DA,49,AB,CD,BA,BB,3E,01,32,7F,AB,21,90
45 DATA 01,22,7D,AB,CD,4E,AB,3E,2F,CD,1E,BB,20,6A,3E,0D,00,00,CD,2B
50 DATA BD,3E,0A,00,00,CD,2B,BD,3E,1B,CD,2B,BD,3E,41,00,00,CD,2B,BD
55 DATA 3E,07,CD,2B,BD,3E,1B,CD,2B,BD,3E,4B,00,00,CD,2B,BD,3E,7F,CD
60 DATA 2B,BD,3E,02,CD,2B,BD,11,00,00,CD,56,AB,13,7A,FE,02,20,F7,7B
65 DATA FE,7F,20,F2,3E,1B,CD,2B,BD,3E,4B,00,00,CD,2B,BD,3E,01,CD,2B
70 DATA BD,3E,00,CD,2B,BD,E5,CD,56,AB,E1,3E,07,32,7F,AB,7D,B4,20,89
75 DATA F1,D1,E1,C1,C9,F5,CD,2E,BD,38,FB,F1,C9,D5,01,00,00,2A,7D,AB
80 DATA 3A,7F,AB,E5,F5,C5,CD,F0,BB,C1,CB,10,80,47,F1,E1,2B,00,D1,D5
85 DATA 3D,20,EC,78,CD,4E,AB,CD,2B,BD,D1,C9
90 PRINT "Program now loaded. Press G for graphics mode or T for text mode."
95 a$=INKEY$:IF a$="" THEN 95
100 IF a$="T" OR a$="t" THEN POKE &AACB,4:POKE &AB6E,43:GOTO 115
105 IF a$="G" OR a$="g" THEN POKE &AACB,1:POKE &AB6E,0:GOTO 115
110 GOTO 95
115 PRINT a$:" Mode. Hold down Space-bar to stop dump -":LIST
    
```

Enter Call 43709 as a direct command and the screen will be dumped to the printer. If the printer is not connected and switched on, the Call will return directly to the Basic. Immediately before saving the program to tape, replace line 150 by

150 New

and the loader can then be used to enter the machine code into the CPC-464 and delete itself before you write your own Basic program.

This should use the command Call 43709 whenever a printout is required and

it can switch between text and graphics modes by using the Pokes in lines 100 and 105 of the loader. Holding down the space bar will abort a dump and return control to Basic.

Make the first line of your program

10 MEMORY 43708: LOAD"!"
and the last line line

60000 SAVE"YOURPROGRAM":
SAVE"!DUMP",B,43709,192

Goto 60000 will now save both the Basic and the machine code; reloading the program with Run" will load both. 

AABD	10	ORG 43709	AB2C	0C	580	NOP
BD2B	20	PRINT: EGU £BD2B	AB2D	00	590	NOP
	30		AB2E	CD2BBD	600	CALL PRINT ;Reset printer to graphic
AABD	C5	PUSH BC	AB31	3E01	610	LD A,1
AABE	E5	PUSH HL	AB33	CD2BBD	620	CALL PRINT
AABF	D5	PUSH DE	AB36	3E00	630	LD A,0
AACO	F5	PUSH AF	AB38	CD2BBD	640	CALL PRINT ; - for one byte.
AAC1	CD2EBD	CALL £BD2E	AB3B	E5	650	PUSH HL
AAC4	DA49AB	JP C,HOME	AB3C	CD56AB	660	CALL BITS ;Read and print last byte
AAC7	CD8ABB	CALL £BBBA	AB3F	E1	670	POP HL
AACA	3E01	LD A,1	AB40	3E07	680	LD A,7
AACC	327FAB	LD (DOTS),A	AB42	327FAB	690	LD (DOTS),A ;Reset scan to 7 bits.
AACF	Z19001	LD HL,400	AB45	7D	700	LD A,L
	140		AB46	B4	710	OR H
AAD2	227DAB	LD (LINE),HL ;Line count.	AB47	2089	720	JR NZ,ROW ;Loop for 29/58 rows.
AAD5	CD4EAB	CALL £WAIT ;wait if printer busy.	AB49	F1	730	POP AF
AAD8	3E2F	LD A,47 ;SPACE-BAR -	AB4A	D1	740	POP DE
AADA	CD1EBB	CALL £BB1E ; if pressed -	AB4C	E1	750	POP HL
AADD	206A	JR NZ,HOME ; return to BASIC.	AB4C	C1	760	POP BC ;Restrcr registers
AADF	3E0D	LD A,13	AB4D	C9	770	RET ;and return to BASIC.
AAE1	00	NOP			780	
AAE2	00	NOP	AB4E		790	WAIT:
AAE3	CD2BBD	CALL PRINT ;Carriage return.	AB4E	F5	800	
AAE6	3E0A	LD A,10	AB4F	CD2EBD	810	BUSY: PUSH AF
AAE8	00	NOP	AB52	38FB	820	CALL £BD2E ;Test if printer busy
AAE9	00	NOP	AB54	F1	830	JR C,BUSY ;and loop till free.
AEA	CD2BBD	CALL PRINT ;Paper feed.	AB54	F1	830	POP AF
AAED	3E1B	LD A,27	AB55	C9	840	RET
AAEF	CD2BBD	CALL PRINT			850	
AAF2	3E41	LD A,"A"	AB56		860	BITS:
AAF4	00	NOP	AB56	D5	870	PUSH DE
AAF5	00	NOP	AB57	010000	880	LD BC,0 ;B will hold byte.
AAF6	CD2BBD	CALL PRINT	AB5A	2A7DAB	890	LD HL,(LINE) ;Top line of row.
AAF9	3E07	LD A,7	AB5D	3A7FAB	900	LD A,(DOTS) ; 1, 4 or 7.
AAF8	CD2BBD	CALL PRINT ;Line spacing to 7/32"	AB60	E5	910	LOOP: PUSH HL
AAFE	3E1B	LD A,27	AB61	F5	920	PUSH AF
AB00	CD2BBD	CALL PRINT	AB62	C5	930	PUSH BC
AB03	3E4B	LD A,"K"	AB63	CDFOBB	940	CALL £BBFO ;"GRA TEST ABSOLUTE"
AB05	00	NOP	AB66	C1	950	POP BC
AB06	00	NOP	AB67	CB10	960	RL B ;Multiply by 2 and
AB07	CD2BBD	CALL PRINT ;Printer set to graphics	AB69	80	970	ADD A,B ;add bit (if any)
AB0A	3E7F	LD A,127	AB6A	47	980	LD B,A ; into B.
AP0C	CD2BBD	CALL PRINT	AB6B	F1	990	POP AF
AB3F	3E02	LD A,2	AB6C	E1	1000	POP HL
AB11	CD2BBD	CALL PRINT ; - for 639 bytes.	AB6D	2B	1010	DEC HL ;Step down 1
AB14	110000	LD DE,0 ; Byte counter.	AB6E	00	1020	NOP ; or 2.
AB17	CD56AB	CALL BITS ;Read and print a byte,	AB6F	D1	1030	POP DE
AB1A	13	INC DE	AB70	D5	1040	PUSH DE
AB1B	7A	LD A,D	AB71	3D	1050	DEC A
AB1C	FE02	CP 2	AB72	20EC	1060	JR NZ,LOOP ;Loop "DOTS" times.
AB1E	20F7	JR NZ,BYTE	AB74	78	1070	LD A,B
AB20	7B	LD A,E	AB75	CD4EAB	1080	CALL £WAIT
AB21	FE7F	CP 127	AB78	CD2BBD	1090	CALL PRINT ;Print byte.
AB23	20F2	JR NZ,BYTE ;repeat for 639 bytes.	AB7B	D1	1100	POP DE
AB25	3E1B	LD A,27	AB7C	C9	1110	RET ;Return to ROW loop.
AB27	CD2BBD	CALL PRINT			1120	
AB2A	3E	LD A,"K"	AB7D		1130	LINE: DEFS 2 ; Line count.
			AB7F		1140	DOTS: DEFS 1 ;Height of row in bits.



IMPORTANT NOTICE TO PROSPECTIVE APPLE PRODUCT PURCHASERS

IT IS IN YOUR INTEREST to purchase from your local Apple Dealer where you can buy Apple Products at **5% below the price advertised** in any current UK computer magazine, provided it is genuine.

Just take the magazine containing the advertisement to your local Apple Dealer listed below, together with this magazine, to claim the 5% saving on your purchase.

NB Dealer must remove and retain the original advertisement.

Date of Purchase must be by the 15th of the month on the cover of the magazine containing the qualifying advertisement.

One product per purchaser only.

Offer expires at the end of the month appearing on the cover of this magazine. It is subject to product availability and genuine non-conditional advertisement being qualified by your dealer. (Dealer's decision is final).

PARTICIPATING DEALERS:

- Berkshire 0753 823820 (Slough)
- Hertfordshire 0992 466650 (Hoddesdon)
- Kent 0622 858753 (Maidstone)
- London North 01-446 2367 (Whetstone)
- London South 01-680 4484 (Croydon)
- London South East 01-851 3311 (Eitham)
- London South West 01-946 2222 (Wimbledon)
- London West 01-741 5411 (Hammersmith)
- Middlesex 01-429 1060 (Harrow)
- Surrey 0883 48919 (Caterham)

 *BEST DEAL WITH YOUR LOCAL DEALER*

Saving and Loading

IT IS USEFUL to be able to save blocks of memory to disc or tape, and to load them back from within a program. This can be very difficult since Commodore machines reset many pointers when a Load has occurred and will also try to run the program in memory when the Load is completed.

The routines given are for the 64 and

allow this to be performed much more easily. The first routine, at line 60000, saves a block of memory such as a high-resolution screen or block of machine code, where SA is the starting address and EA the end address plus 1.

The routine at line 60100 loads it back at an address specified by SA, which could be different from the address where the

block was originally. If it is simply a matter of loading it back to the same locations that it originally occupied, then use the routine at line 60200.

The Sys commands in all three routines are in the same form as the normal Load and Save. These are shown for disc, device 8, but work equally well for the cassette by changing this to 1.

Memory save.

```
60000 REM ***** SAVE BLOCK OF MEMORY
60010 REM ***** FROM SA TO EA

60020 SH=INT(SA/256): SL=SA-SH*256
60030 EH=INT(EA/256): EL=EA-EH*256
60040 SYS(57812) "FILENAME",8
60050 POKE 780,2: POKE 2,SL: POKE 3,SH
60060 POKE 781,EL: POKE 782,EH
60070 SYS(65496)
60080 RETURN
```

Load to new address.

```
60100 REM ***** LOAD BLOCK OF MEMORY
60110 REM ***** STARTING AT SA

60120 SH=INT(SA/256): SL=SA-SH*256
```

```
60130 SYS(57812) "FILENAME",8
60140 POKE 781,SL: POKE 782,SH
60150 POKE 780,0
60160 SYS(65493)
60170 RETURN
```

Reload to original address.

```
60200 REM ***** LOAD BLOCK OF MEMORY
60210 REM ***** FROM WHENCE IT CAME

60220 SYS(57812) "FILENAME",8,1
60230 POKE 780,0
60240 SYS(65493)
60250 RETURN
```

High-resolution screen dump

The high-resolution graphics capabilities of both the Commodore 64 and the Epson MX and FX printers are well suited to each other — that is, as long as you have the software to take the high-resolution image in the 64 and convert it to the appropriate bit-image data.

This can be done very slowly in Basic, or much faster in machine code. This

program is based on one from J R Jones and is a mixture of the two. It shows how machine code can be used to speed up the slower parts of Basic. The data format required by the printer is different to the 64's internal representation and the machine code in the program takes care of this conversion.

The printer is first set in line 1020 to a line spacing so that there are no gaps between the printed lines. Then all 25 lines of the screen, each containing eight high-resolution lines, are printed. Line 1035 sets

the printer into bit-map mode, expecting 320 characters of data. The routine at 1040 sends eight characters of data at a time, sent by the machine code.

The machine code occupies the cassette buffer, but is fully relocatable and could be placed anywhere convenient simply by changing the value of S in line 1800.

The program assumes in lines 1015 that the high-resolution screen starts at 8192. This is alterable provided that the screen can be read and is not sitting underneath one of the ROMs.

High-resolution screen dump.

```
1000 REM **** MX80 SCREEN DUMP
1005 GOSUB 1800 :REM SET UP M.CODE

1010 OPEN 1,4
1015 SA=8192
1020 PRINT#1,CHR$(27); "A"; CHR$(8);

1030 FOR Y=0 TO 24
1035 PRINT#1,CHR$(27); "K"; CHR$(64);
CHR$(1);

1040 FOR BY=0 TO 312 STEP 8
1050 SP=BY+320*Y+SA
1060 MS=INT(SP/256)
1070 LS=SP-MS*256
1080 POKE 150,LS: POKE 151,MS

1100 SYS S
1110 NEXT BY

1120 PRINT#1,CHR$(10)
1130 NEXT Y
1135 CLOSE 1
1140 END

1798 REM POKE IN MACHINE CODE ROUTINE
1800 S=832: C=0
1810 READ X
1820 IF X>255 THEN 1850
1830 POKE S,X: C=C+X: S=S+1: GOTO 1810
```

(continued on next page)

(continued from previous page)

```

1850 IF X<>C THEN PRINT"DATA ERROR":STOP
1860 RETURN

1999 REM DATA FOR MACHINE CODE
2010 DATA 165,150,133,97,165,151,133,98
2015 DATA 169,128,133,99,169,0,133,174
2020 DATA 169,128,133,175,160,0,177,150
2025 DATA 37,99,197,99,208,7,165,174

2030 DATA 24,101,175,133,174,70,175,166
2035 DATA 175,224,0,208,23,152,72,162
2040 DATA 1,32,201,255,165,174,32,210
2045 DATA 255,104,168,70,99,166,99,224
2050 DATA 0,208,16,96,165,150,24,105
2055 DATA 1,144,2,230,151,133,150,240
2060 DATA 195,208,193,165,97,133,150,165
2065 DATA 98,133,151,240,175,208,173
2070 DATA 12763
    
```

Reverse Rems and Relocator revisited

The Reverse Rems program in the November 1984 Commodore Open File prompted several readers to point out that it does not work on the Commodore 64

due to the use of locations 0 and 1.

There were other problems with this program and Mike Hart of Wigston in Leicestershire has produced a more robust version. It is listed as a Basic loader and as a disassembly, and is executed with Sys828 For Basic 2/4 Pets, change line 11 to

11 DATA 165,41

In the same issue, the Relocator also suffered problems and M E Funnell has

offered a modified version. The major problem is that location \$408F should have been \$F0 and not \$D0 — that is BEQ and not BNE. In addition, the revised version preserves locations \$54 and \$55 to avoid the need for additional Pokes.

Mr Funnell also points out that the program does not relocate itself as described, as it modifies its own internal addresses while executing.

Modified Relocator.

```

4000 AA AA AA AA AA AA AA AA
4008 AA AA AA AA A5 54 48 A5
4010 55 48 AD 08 40 38 ED 04
4018 40 8D 0A 40 AD 09 40 ED
4020 05 40 8D 0B 40 AD 00 40
4028 85 54 AD 01 40 85 55 A0
4030 00 B1 54 20 83 40 C9 03
4038 D0 2F C8 B1 54 CD 04 40
4040 C8 B1 54 ED 05 40 90 1F
4048 88 B1 54 CD 06 40 C8 B1
4050 54 ED 07 40 B0 11 88 B1

4058 54 18 6D 0A 40 91 54 C8
4060 B1 54 6D 0B 40 91 54 A9
4068 03 18 65 54 85 54 90 02
4070 E6 55 CD 02 40 A5 55 ED
4078 03 40 90 B3 68 85 55 68
4080 85 54 00 48 C9 20 F0 0C
4088 29 1F C9 19 F0 06 29 0C
4090 C9 0C D0 04 68 A9 03 60
4098 68 29 9F F0 06 29 0D 49
40A0 08 D0 03 A9 01 60 A9 02
40A8 60 AA AA AA AA AA AA AA
    
```

Reverse Rems.

```

1 REM *** DISTINCT-REMS ***
2 REM *** BY M. C. HART ***
3 :
4 FORJ=828 TO 882
5 READ A:POKEJ,A:C=C+A
6 NEXT
7 :
8 READ K
9 IF K<>C THEN PRINT"DATA ERROR"
10 :
11 DATA 165.44
12 DATA 133.89,169.5,133.88
13 DATA 160,0,177,88,240,19,201,143
14 DATA 240,8,230,88,208,242,230,89
15 DATA 208,238,200,169,18,145,88,208
16 DATA 241,200,177,88,200,17,88,240
17 DATA 13,24,169,5,101,88,133,88
18 DATA 144,214,230,89,176,210,96
19 :
20 DATA 7494

Disassembly.
033C A5 2C LDA $2C
033E 85 59 STA $59
0340 A9 05 LDA #$05
0342 85 58 STA $58
0344 A0 00 LDY #$00

0346 B1 58 LDA ($58),Y
0348 F0 13 BEQ $035D
034A C9 0F CMP #$0F
034C F0 08 BEQ $0356
034E E6 58 INC $58
0350 D0 F2 BNE $0344
0352 E6 59 INC $59
0354 D0 EE BNE $0344
0356 C8 INY
0357 A9 12 LDA #$12
0359 91 58 STA ($58),Y
035B D0 F1 BNE $034E
035D C8 INY
035E B1 58 LDA ($58),Y
0360 C8 INY
0361 11 58 ORA ($58),Y
0363 F0 0D BEQ $0372
0365 18 CLC
0366 A9 05 LDA #$05
0368 65 58 ADC $58
036A 85 58 STA $58
036C 90 D6 BCC $0344
036E E6 59 INC $59
0370 B0 D2 BCS $0344
0372 60 RTS
0373 00 BRK
    
```

GALAXY WEST ONE GALAXY

BUSINESS SYSTEMS LTD

230 Tottenham Court Road, London W1. Telephone: 01-636 7142/4102

Looking for a business system? Let us help you. Call in or phone for friendly, professional advice.



apricot x10
10MB WINCHESTER
ONLY £1995 + VAT!
PLUS

- FREE Wordprocessor (Superwriter)
- FREE Spreadsheet (Supercalc)
- FREE Super Planner

- INTEGRATED ACCOUNTS PACKAGE**
- FREE Invoicing
 - FREE Stock Control
 - FREE Sales Ledger
 - FREE Purchase Ledger
 - FREE Nominal Ledger
 - FREE Payroll

SPECIAL INTRODUCTORY OFFER



apricot PC



DUAL 315K DRIVES (630K) ONLY
£1395 + VAT!
PLUS

APRICOT PORTABLE
only
£1495 + VAT

- FREE ACT 9" Monitor
- FREE Superwriter (Wordprocessor)
- FREE Supercalc (Spreadsheet)
- FREE Superplanner
- FREE CPIM 86
- FREE Concurrent CPIM 256K Memory



SANYO MBC
WITH 2x720KB FLOPPY DISC
ONLY £995 + VAT!

PLUS

- FREE Monitor
 - FREE Wordprocessor (Wordstar)
 - FREE Spreadsheet (Calstar)
 - FREE Invoicing
 - FREE Stock Control
 - FREE Sales Ledger
 - FREE Purchase Ledger
 - FREE Nominal Ledger
 - FREE Payroll
- Integrated Accounts Package

GALAXY BARGAINS

SANYO with 10MB Winchester floppy, 128K Ram, Wordstar & Calstar and Monochrome Monitor
£1995 + VAT

APRICOT PC: DUO
 720K discs and monitor
£1595 + VAT

APRICOT Xi5: 5MB Winchester
£1845 + VAT

APRICOT F1 **£949.00 + VAT**
 PHILIPS MONITOR **£65.00 + VAT**

PLUS FREE INTEGRATED ACCOUNTS PACKAGE WITH THESE SYSTEMS

TRAINING CAN BE PROVIDED ON ALL SYSTEMS SUPPLIED

We also stock a wide range of Printers, Monitors, Disc Drives and Software Packages, plus many other Computer Systems at bargain prices.

1 YEAR WARRANTY & MAINTENANCE CONTRACTS AVAILABLE

OPENING HOURS MON-SAT 9AM-6PM

MAIL ORDERS TO: West One Galaxy Business Systems Ltd, 230 Tottenham Court Road, London, W1.

Cheques payable to: West One Galaxy Business Systems Ltd.



ETAFIELD

THE PROBLEM SOLVERS
PRESENT

**HIGH RESOLUTION
COLOUR GRAPHICS BOARD**

- * **RUNS DIRECTLY ON
IBM PC/XT/AT AND
OTHER IBM HARD-
WARE COMPATIBLES**
- * **1000 × 1000 × 4
PIXELS**
- * **RUNS MOST
LANGUAGES**
- * **SUITABLE FOR MOST
MONITORS**
- * **RUNS AUTOCAD
WITH MOUSE**

FOR MORE INFORMATION CONTACT
**CHRIS PEARCE, ETAFIELD LTD.,
SUMMIT HOUSE, HORSECROFT RD.,
HARLOW, ESSEX CM19 5BN
TELEPHONE: HARLOW (0279) 26606**

TO CHRIS PEARCE
I WANT INFORMATION ON COLOUR GRAPHICS

NAME

ADDRESS

COMPANY

TELEPHONE

● Circle No. 160

3 1/2" or 5 1/4" WINCHESTERS

FOR
**GEMINI/NASCOM, SUPERBRAIN,
IBM, APRICOT, SIRIUS
AND EPSON COMPUTERS**

★ ★ INTRODUCTORY OFFER ★ ★

5 1/4" 10 MB VERSION £999 + VAT

★ OTHER CAPACITIES/SIZES
AVAILABLE

★ FACILITIES FOR MOST
COMPUTERS ON REQUEST

★ 64K PRINTER BUFFER, WITH
PARALLEL SERIAL INTERFACES.
RING FOR DETAILS

TEL (0245) 57575

Ask about our disk copying service –
only £8+ VAT.

For further details. Securicor delivery, back
up support and HP terms available.

CIRTRIK

29 Beeches Road, Chelmsford, Essex
CM1 2RX

VAT No. 407 0905 74

● Circle No. 169

The 'Classic' Menu Generator.

Eliminate all user contact
with operating system
commands. Use **MENUGEN**
from Microft Technology to
create menus to access all
your regularly used programs.

MENUGEN is a utility
which will create menus for
any activity. A menu selection
will run a program, call another menu, return to a
previous menu, run a basic program, execute operating
system commands, or exit to the operating system.

FACILITIES INCLUDE

UP TO 16 MENU OPTIONS PER MENU SCREEN
UP TO 15 LEVELS OF NESTED MENU
OPTIONAL PASSWORD PROTECTION ON
MENU SELECTIONS · OPTIONAL LOGGING
OF ALL SELECTIONS TAKEN

MENUGEN is available for most micros with one
of either the CPM or MS-DOS family of operating
systems, including IBM PC and compatibles, Sirius,
Apricot and many Z80 machines. **MENUGEN** costs
£48 + VAT (£55.20) and is available from Microft
Technology Limited, 45a Radnor Walk, London SW3 4BP.
To order, or for information, telephone 01-352 7876.

MENUGEN

MENUGEN is a Trade Mark of Microft Technology
Limited and is a British product.

● Circle No. 151

Cash & Carry COMPUTERS

at HI VOLTAGE

Croydon's New 13,000 sq ft Computer Discount Centre

Expert Staff • Free Advice • Everything on Demonstration • Open 9am-6pm Monday-Saturday • Access & Visa cards accepted

UK's Best Printer Prices

London's Largest Range of Printers on Demonstration

DOT MATRIX PRINTERS

Brother HR5	£129.90 + VAT =	£149.38
Brother M1009	£169.90 + VAT =	£195.38
Brother 2024L NLQ	£899.90 + VAT =	£1034.88
Epson P40 Thermal AC/DC	£81.90 + VAT =	£94.18
Epson RX80	£199.90 + VAT =	£229.88
Epson RX80FT+	£225.90 + VAT =	£259.78
Epson FX80	£329.90 + VAT =	£379.38
Epson RX100FT	£349.90 + VAT =	£402.38
Epson FX100	£449.90 + VAT =	£517.38
Epson LQ1500 NLQ	£895.90 + VAT =	£1030.28
Epson JX80 Colour	£499.90 + VAT =	£574.88
Canon PW1080A NLQ	£299.90 + VAT =	£344.88
Canon PW1156A NLQ	£389.90 + VAT =	£448.38
Canon PJ1080A Colour	£479.90 + VAT =	£551.88
Panasonic KP1091 (IBM) NLQ	£279.90 + VAT =	£321.88
Shinwa CPA80	£199.90 + VAT =	£229.88
Anadex DP6500	POA	
Anadex WP6000	POA	
Newbury DRE8850	POA	
Newbury DRE8925	POA	
NEC Pinwriter P2	POA	
NEC Pinwriter P3	POA	
Seikosha GP50S (Sinclair Spectrum)	£79.90 + VAT =	£91.88
Seikosha GP500A	£113.90 + VAT =	£130.88
Seikosha GP700A Colour	£243.43 + VAT =	£279.95
Smith Corona Fastext 80	POA	
Smith Corona D100	POA	
Smith Corona D200 NLQ	POA	
Kaga Taxan KP810 NLQ	£289.90 + VAT =	£333.39
Kaga Taxan KP910 NLQ	£379.90 + VAT =	£436.89
Commodore MPS801	£130.39 + VAT =	£149.95

DAISYWHEEL PRINTERS

Brother HR15	£329.90 + VAT =	£379.39
Brother HR25	£589.90 + VAT =	£678.39
Brother HR35	£695.90 + VAT =	£800.29
Daisystep 2000	£239.90 + VAT =	£275.89
Diablo 630 API	POA	
Diablo 620 RD	POA	
Juki 6100	£349.90 + VAT =	£402.39
Juki 6300	£679.90 + VAT =	£781.89
NEC	POA	
Gume	POA	
Ricoh	POA	
Tec	POA	
Epson DX100	£389.90 + VAT =	£448.39
Commodore DPS1101	£309.90 + VAT =	£356.39

PRINTER/TYPEWRITERS

Brother EP22	£109.90 + VAT =	£126.39
Brother EP44	£189.90 + VAT =	£218.39
Brother TC600	£373.50 + VAT =	£429.53
Brother FB100 Disk Drive for TC600	£161.50 + VAT =	£185.73
Juki 2200 Daisywheel (P or S)	£249.90 + VAT =	£287.39

All popular interfaces, cables, etc. available from stock.
Custom cables made to order.

Let our experts match your computer to the printer of your choice.

Printers — All models parallel-centronics interface Serial RS232C available at same or slightly higher prices.

Prices correct at copy date. Subject to change without notice due to currency fluctuations etc. E. & D.E.

MONITORS

Microvitec Colour		
1431 DS STD RES RGB	£169.90 + VAT =	£195.39
1431 DZ STD RES Spectrum	£199.90 + VAT =	£229.89
1451 DS MED RES RGB	£229.90 + VAT =	£264.39
1451 DQ MED RES QL	£229.90 + VAT =	£264.39

CASH & CARRY COMPUTERS

53-59 High Street,
Croydon, Surrey CR0 1QD.

1451 APDS MED RES RGB/Composite	£289.90 + VAT =	£333.39
1441 DS High RES RGB	£389.90 + VAT =	£448.39
1446 LI MED RES IBM PC	£439.90 + VAT =	£505.89
Fidelity CM14 STD RES RGB/Composite	£159.90 + VAT =	£183.89
Commodore 1702 STD RES Composite	£179.90 + VAT =	£206.89
Sinclair/Kaga QL Vision RGB	£249.90 + VAT =	£287.39
Sanyo 3125 STD RES RGB	£172.90 + VAT =	£198.84
Sanyo 3117 MED RES RGB	£284.90 + VAT =	£327.64
Sanyo 3115 High RES RGB	£399.90 + VAT =	£459.89
Sanyo 2112 Green SCRNI MED RES	£65.00 + VAT =	£74.75
Sanyo 8112 Green SCRNI High RES	£88.00 + VAT =	£101.20
Sanyo CRT36 Green SCRNI High RES	£118.90 + VAT =	£136.74

PRINTER RIBBONS

Single prices, deduct 10% for 5+

Brother HR15 Corr	£2.65 + VAT =	£3.05
Brother HR15 MS	£4.95 + VAT =	£5.69
Brother HR5	£2.70 + VAT =	£3.11
Brother EP44	£2.50 + VAT =	£2.88
Brother M1009	£3.60 + VAT =	£4.14
Canon PW1080A	£9.50 + VAT =	£10.93
CBM 801	£6.50 + VAT =	£7.48
CBM 802/1526	£5.90 + VAT =	£6.79
CBM 1525	£4.00 + VAT =	£4.60
CBM DPS1101 MS	£3.50 + VAT =	£4.03
Daisystep 2000	£3.50 + VAT =	£4.03
Epson 80 Series	£4.80 + VAT =	£5.52
Epson 100 Series	£6.00 + VAT =	£6.90
Juki 6100 SS	£1.80 + VAT =	£2.07
Juki 6100 MS	£3.50 + VAT =	£4.03
Juki 2200	£3.50 + VAT =	£4.03
Kaga KP810	£9.50 + VAT =	£10.93
Mannesman MT80	£5.90 + VAT =	£6.79
Seikosha GP50	£6.50 + VAT =	£7.48
Seikosha GP100	£4.00 + VAT =	£4.60
Seikosha GP500	£6.50 + VAT =	£7.48
Seikosha GP700	£18.50 + VAT =	£21.28
Shinwa CP80	£5.90 + VAT =	£6.79

Also in stock Diablo, Anadex, Gume, NEC, Ricoh & OKI Ribbons.

LOCKABLE ABA DISK BOXES

M35 40 x 5. 1/4in.	£13.50 + VAT =	£15.53
M50 50 x 5. 1/4in.	£14.50 + VAT =	£16.68
M85 80 x 5. 1/4in.	£16.50 + VAT =	£18.98
M100 100 x 5. 1/4in.	£18.50 + VAT =	£21.28
MD60 60 x 3. 1/2in.	£14.50 + VAT =	£16.68

**Mail Order + Export + Trade
Hot Line Phone 01-686 6362**



Delivery by Securicor (3 day) please add £5.00 + VAT per item.
Delivery by T.N.T. (overnight) please add £9.50 + VAT per item.

Send off the coupon or order by phone quoting your Access, Barclaycard No. Phone 01-686 6362. Immediate despatch on receipt of order or cheque clearance.

Or you can Telex your order on: 946240 Attn 19001335

We accept official orders from PLC's, Government Departments and Educational establishments.

These prices correct until superceded by next advertisement.

To: Cash & Carry Computers, 53-59 High Street, Croydon, Surrey CR0 1QD.

Please supply _____

I enclose my cheque for £_____ including delivery by Securicor/T.N.T.*

or charge my Access/Barclaycard No. _____

Name _____ Signature _____

Address _____

PC 4

*Please Delete



Rosco Ltd



ROSCO — APRIL

We are dealers for
THE ERICSSON PC.
100% IBM compatible.
Voted best buy.
High specification at low cost.

FOR YOUR APPLE

DISC DRIVES

Cumana (Half Height, Direct Drive)	139
Apple (Full Height)	199

PERIPHERAL CARDS

NB Rosco Printer card CP/M Pascal + Applesoft compatible & full graphic dump

Printer Centronic	38
Printer + 16K buffer	89
Printer + 64K buffer	129
Printer Cable	12
80 Column (Not Ile)	48
80 Column Inc Inverse video chip. (New Version. Not Ile)	54
Expandable 80 Column (Ile)	49
Extended 80 Column (+ 64K)	89
64K Upgrade Kit for 80 Col.	49
Disc Controller	36
PAL (+ Modulator)	49
16K RAM	44
RS232 (Serial Card)	42
Parallel/Serial Interface	59
Serial/Communication	79
Z80 CP/M	44

PRINTERS

BROTHERS

	Our price
EP 22	99
EP 44	199
HR 5	119
HR 15	399
HR 25	595
HR 35	795
EM 101	849

CANON/KAGA

PW1080A (NLQ, 80 Col.)	299
PQ1156A (NLQ, 156 Col.)	399

EPSON

RX 80T	189
RX 80FT	239
RX 100FT	399
MX 100 III	339
FX 80	359
FX 100FT	479
DX 100	419
LQ 1500	999

JUKI

6100	359
------	-----

MONITORS

KAGA

	Our Price
12" Hi Res (Green)	109
12" Hi Res (Amber)	109
12" Nor Res (PAL/RGB)	199
12" Med Res (RGB)	259
12" Hi Res (RGB)	359

SANYO

12" Nor Res (Green)	69
12" Hi Res (Green)	109
14" Nor Res (RGB)	239
14" Med Res (RGB)	349
14" Hi Res (RGB)	499

NORMENDE

	Our Price
14" TV/RGB Monitor	169

We carry a range of computers to suit most requirements.

Ring for prices on other Peripherals and Software

Plus 15% VAT on all prices
P&P: Under £100 Add £3 + VAT
Over £100 Add £5 + VAT

For despatching PRINTERS/MONITORS/COMPUTERS please add £8.50 + VAT per item



APPLE IS THE TRADE MARK OF
APPLE COMPUTER INC.



Rosco Ltd

289 Birchfield Road,
Birmingham B20 3DD

Tel: 021-356 7402
Telex: 334303 TXAGWMG



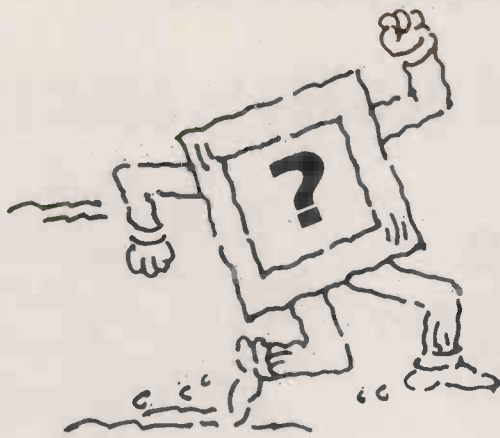

The fastest spreadsheet is understandably better.

SuperCalc® 3, Release 2

SuperCalc 3 with FastMath™ is faster than any other competitive spreadsheet. A lot faster. This means while you're waiting for others to calculate, you could be off and running with SuperCalc 3, Release 2. And on top of its astonishing speed, it's all on one disc to simplify usage. We've simplified the price, too. It's about **£80** lower than its best known rival.

SuperCalc 3, Release 2 provides the broadest range of functional capabilities. You get a better data manager, and the

most sophisticated graphics of any integrated program. Your spreadsheets will be more meaningful, more understandable.

Yet it's surprisingly easy to learn and use. From easy startup, to extensive tutorials, to deeper, more efficient modelling, the more you get into SuperCalc 3, Release 2, the better it treats you.

Speed, flexibility, depth... no wonder it takes you further, faster.



Easy Software working harder.

Sorcim/IUS Products: EasyWriter 1 System, EasyWriter II System, SuperWriter, SuperCalc 3 Rel.2, and other SuperCalc Software, EasyFiler, and EasySales Pro.

Special offer: Free demo diskette

Please send me a Free Demo Diskette* so I can preview the features and effectiveness of SuperCalc® 3, Release 2.

Name _____

Address _____

Tel: _____

Post this coupon to:
Sorcim/IUS, 10 Station Road, Watford,
Herts WD1 1EG. Tel: (0923) 46255.

*Diskette is designed for use with IBM-PC® or fully compatible hardware systems. IBM-PC is a registered trademark of International Business Machines Corporation.



Micro Computer Disks LTD

FOR ALL COMPUTER SUPPLIES

Lowest prices for highest quality products!



Floppy disks:

maxell. £2.09

Dysan CORPORATION £1.89 each

3M £1.72

Ribbons: Diablo Multistrike £1.72

Daisywheels: Diablo/Qume only £3.95

(0990) 23002/3



NO MIDDLE MEN! NO FRILLS! STRAIGHT FROM THE WAREHOUSE!

MICRO COMPUTER DISKS LIMITED Wilburn House, London Road, Sunningdale, Berks. SL5 0ER

● Circle No. 190



How To Make Money From Your Software

LEGAL AND BUSINESS ASPECTS

ANNE STAINES LL.M. Barrister

A GUIDE TO

- The legal protection of computer software
- Confidential information
- Piracy and counterfeiting
- Trade marks and 'passing off'
- Your legal rights
- Setting up a business or selling through an established software publisher
- Raising finance
- Marketing and selling
- Contracts
- Exports
- Useful addresses

ORDER FORM

PAYMENT WITH ORDER

To: ESC Publishing Limited, 25 Beaumont Street, Oxford OX1 2NP

Please supply _____ copy/copies of **How to Make Money from Your Software** by Anne Staines at £6.75 plus 80p post and packing

Name _____

Address _____

ESC Publishing Limited Co. Reg. No. 1335403
VAT Reg. No. 311 4190 09

PRICE £6.75

Available from bookshops or direct from ESC Publishing Limited

● Circle No. 189

LOWEST PRICES IN UK?

MICROCOMPUTERS	£	Canon PJ1080A (Colour)	409.00
BBC B	295.00	Canon PW1156A	365.00
BBC B + DFS	369.00	Ricoh 1200S	525.00
Electron	109.00	Toshiba 2100H	1295.00
Commodore 64, 16 and plus 4	P.O.A.	FOR THE BBC	£
Apricot 2 x 5.5 discs + monitor	1999.00	CUMANA CS100 40tk ss 100K	129.00
Apricot 2 x DS discs + monitor	1549.00	CUMANA CS200 80tk ss 200K	159.00
Apricot XI 10 meg + monitor	2195.00	CUMANA CS400 80tk ds 400K	184.00
Apricot F1 inc monitor	1070.00	CUMANA CD200 dual 40tk ss 200K	225.00
Apricot Portable (256K)	1375.00	CUMANA CD400S dual 80tk ds 400K	289.00
Epson QX10	850.00	CUMANA CD800S dual 80tk ds 800K	339.00
Epson PX8	648.00	Monitors M" vitec 1431 Normal Res	177.00
Epson PX8 Inc RamPack	775.00	Monitors M" vitec 1451 Med Res	260.00
Epson HX20 + case + cassette	389.00	Monitors M" vitec 1441 Hi Res	399.00
Sanyo 555	895.00	Monitors Philips 14" monitor/TV (2007)	199.00
Sanyo 555 double sided	1165.00	Monitors Sanyo 3125N colour	169.00
Sanyo 775 IBM colour portable	1690.00	Monitors Sanyo 3117M med res colour	293.00
Kaypro 2	935.00	Monitors Sanyo 3115H hi res colour	389.00
Kaypro 4	1375.00	Monitors Sanyo Mono HiRes 18MHz	99.00
Kaypro 10	1995.00	Monitors Zenith Amber/green	77.00
PRINTERS		6502 2nd processor	175.00
Epson RX80T	190.00	Z80 2nd processor	279.00
Epson RX80FT	210.00	Bn Stick	299.00
Epson FX80	315.00	Teletext Receiver	193.00
Epson MX100	345.00	Prestel Adaptor	110.00
Epson RX100	349.00	ROMS Disc Doctor	27.50
Epson FX100	429.00	ROMS Termi	27.50
Epson LQ1500	855.00	ROMS Graphics	27.50
Epson DX100	369.00	ROMS View or Viewsheet	45.00
Epson JX80 (colour)	465.00	ROMS Wordwise	32.00
Epson P40 thermal (S or P)	75.00	Wordwise Plus	48.00
Epson P80	129.00	Wordwise Sweettalker	21.75
Epson Hl 80 plotter (A4)	329.00	Wordwise Caretaker or Gremlin	27.50
Juki 6100		Tracker Ball	48.00
Juki 6300 40cps daisy (S or P)	699.00	AMX Mouse	72.00
Brother HR15	329.00	SOFTWARE	
Brother HR25	599.00	Wordstar Professional	275.00
Brother HR35	729.00	The Word	219.00
Brother 2024 letter quality dot	835.00	DBase II	239.00
Microline 82A	239.00	Friday	139.00
Microline 92P	359.00	DMS	155.00
Microline 92S	449.00	Delta	375.00
Star Gemini 10	217.00	Lotus 123	295.00
Star Radix 10	449.00	Symphony	425.00
Star Delta 15	444.00	Cardbox	165.00
Star Radix 15	549.00	Open Access	315.00
Shinwa CP 80	169.00	Supercalc 2	165.00
Shinwa CPA 80 (100cps) par	185.00	Supercalc 3	249.00
MP165 (NLQ)	249.00	Brainstorm	245.00
Canon PW1080A	289.00	Framework	325.00

Carriage £10, add 15% VAT to all orders
VISA-ACCESS accepted—cheque clearance 7 days.
Best price on ANY Micro Product. Large SAE (22p) for Catalogue

CENTRAL MICRO DISTRIBUTORS

PO BOX 194—OXFORD—OX3 9AN
TEL. OXFORD (0865) 63544 (MAIL ORDER ONLY)

● Circle No. 171

Easy PC

A selection of reading matter for users of IBM's Personal Computer, plucked by Paul Myers from the deluge of titles.

THE BOOM MARKET of a year ago in computer books is having something of a shake-out. Retailers are returning up to 40 percent of the stocks supplied by some publishers, and Sybex is just one of several companies reportedly laying off staff. Look along the shelves of a computer bookshop and the reason is obvious. There is much duplication, and most of the material is quickly superseded by new technology and new fashion.

When the IBM PC was introduced, easy-to-understand guides to all aspects of its use were required, and the first to publish made profitable sales whatever the quality of the product. Now, two years and several hundred books later, even the most outstanding new guide to Basic programming will find little space on readers' bookshelves.

This is the dilemma for *IBM PC and XT Owner's Manual* by Chertok, Rosenfeld and Stone. It makes an adequate first practical guide for the naive new user but is redundant when you consider what is already available. M De Pace's *The IBM Personal Computer* suffers twice over — by not being first, and by being poorly organised and formatted. This book is not a practical guide, but provides a superficial taste of the usual microcomputer topics like software packages, languages, DOS and hardware.

On the other hand, *A Comprehensive Guide to the IBM Personal Computer* brings together information from IBM manuals and other sources more comprehensively than most. The 53-page "What to get" section covers the choice of hardware and accessories, and the different categories of software available. The 150 pages on operating the PC deal with everything from switching on to the detailed operation of IBM's interactive debugger. Basic seems an obligatory topic for books of this kind but Markowsky's 150 pages find room for esoteric hints like how to get round the bug in IBM's implementation of the Shell command. The curious PC user often ends up with a vague interest in assembler programming, so it is not inappropriate to finish with a 50-page introduction to the subject. The regular references to books and magazine articles and the apparent support given by IBM in its production makes this book one to recommend.

Simon Lucy's *MS-DOS User Book* provides a comprehensive and pleasantly concise guide to Microsoft's generic product. A reference book, it covers the commands, utilities, structure, interrupts and interfaces of version 1.25 of the operating system; it is unfortunate that it has largely been superseded by MS-DOS 2. *Programmer's Guide to MS-DOS for the IBM PC* is less comprehensive. This rather dull book sets out to provide "a full description of the programming interface to the MS-DOS functions". It does provide a reasonable source of information for DOS 2 function calls, each being discussed with



a short program example. The book ends with a 40-page chapter that describes interrupts to the IBM PC BIOS.

Programming the IBM PC & XT: A Guide to Languages has the remarkable aim of teaching novice PC users to operate the machine and to program in Basic, Fortran, Cobol, Pascal, machine language and assembler. The regular review exercises, concise style and compact typesetting cannot make a success of this impossible task as there is far too much material to cover in one tutorial volume. Nevertheless it will stay on my shelves as a reference to languages I am less familiar with.

Volumes on Basic continue to pour forth. David Schneider's *Handbook of Basic for the IBM PC* is for those who find IBM's rather comprehensive manual not comprehensive enough. The book is organised alphabetically by command and gives plenty of detailed description as well as programming examples.

Fancy Programming in IBM PC Basic provides code for essential routines such as controlling numeric keyboard input, menu handling, aligning screen output, sorting and merging, handling linked lists, virtual arrays and the use of pointers. It is a great little book for those whose imagination and programming needs have raced ahead of their programming technique.

Those concerned with gathering the sort of data associated with market surveys and deriving descriptive statistics may find *IBM PC Statistics* of interest. It uses 60 pages of compact Basic code to expound the theory of hypothesis testing, correlation and regression, variance analysis, and other techniques. Children aged six to 12 with a desire to make the computer "do something" should enjoy the problems

presented in *Computer Playground IBM PC*, which is formatted as a large colouring book. It presents short fun routines in Basic, and prompts inquiring minds by setting questions usually answered by a few lines of code.

IBM PC owners frustrated at seeing Basic programs published in this and other journals for Apple, Commodore, Atari and Tandy computers need suffer no more. Harris and Scofield have written *IBM PC Conversion Handbook of Basic*, which enables programs to be translated easily with reference to their instructions.

Graphics and games present an aspect of Basic that is well covered by different authors. Tony Fabbri's *Animation Games and Sound for the IBM PC* requires the minimum-configuration machine and no graphics. From simple shapes for cars and rockets, through making stick men walk or swim, the author leads up to a race-track game with sound effects and the tune of *Yanky Doodle Dandy* to the accompaniment of an on-screen firework display.

J Edward Volkstorf in *Graphics Programming on the IBM Personal Computer* confines himself to Basic and consequently achieves greater clarity with sections on the Basic commands, business graphics, drawing techniques, custom character sets and animation. *Computer Graphics for the IBM Personal Computer* takes the subject further and deeper, and a section on the representation of three-dimensional solid objects more than compensates for the absence of any discussion of the new commands and extensions made available in Basic version 2.

Microcomputer Graphics for the IBM PC provides a sound introduction to the subject. The style is somewhat dry, but the

(continued on next page)

(continued from previous page)

many examples and explanatory diagrams present the subject concisely, so this may double as a textbook and a reference work. *Business Graphics for the IBM PC* sets out to teach the theory and calculations necessary to generate flexible business graphics. For those struggling to get such output from their data through Basic programming this book, with about 1,000 lines of example code, may be just the ticket.

IBM PC owners using VisiCalc can now buy a series of step-by-step guides to make business planning a cinch. *Controlling Financial Performance* has been adapted for a U.K. readership: after a short introduction to the computer and to VisiCalc it provides detailed instructions for setting up a profit-and-loss account. Balance sheets, liquidity, gearing and profitability are all explained in easily understood business terms. Corresponding spreadsheet models are provided with automatic recalculation to show how the software is used as a working tool to make 'What-If?' projections. Template spreadsheets are provided for adapting to the reader's own business, and some indicators are given on controlling financial performance.

Planning and Budgeting uses the same techniques to explore cash budget, pro-forma profit and loss and balance sheet, and forecasting models. *Business Decision Making* covers break-even analysis, overheads, market analysis, pricing, stock control, operations management and cash flow. Like *Controlling Financial Performance*, these books provide sound practical advice to the business user; a disc containing examples and templates is available with each one.

Learning how to program in assembler is an excellent way of becoming familiar with the technical aspects of microprocessor operation. Samuel A Solomon's *IBM PC Assembly Language is Fun and Easy* is the first book I have seen that successfully presents this potentially dry and academic subject in a light-hearted and accessible way. By page 56 six short chapters have covered the bare bones of creating an assembler program: the form of the code, using the editor, assembler and linker, hexadecimal representation, and the testing of a program using the IBM PC's interactive debugger. Subsequent chapters cover logical groups of instructions, put into context by a complete program presented at the end of the book that enables computer memory to be viewed and edited in full screen mode.

Solomon does not attempt to provide a technical reference book, unlike Leo J Scanlon in *8086/88 Assembly Language Programming*. This rewrite removes some of the vagaries of style present in his earlier book; also gone are the direct references to the IBM PC, which seemed to be largely beyond the author's grasp. The book is an adequate catalogue of 8086

IBM PC and XT Owner's Manual by Barbara Lee Chertok et al. Published by Brady/Prentice-Hall International, 200 pages, £17.20. ISBN 0 89303 531 9

The IBM Personal Computer by M de Pace. Published by Granada, 188 pages, £7.95. ISBN 0 246 12151 3

A Comprehensive Guide to the IBM Personal Computer by George Markowsky. Published by Prentice-Hall, 516 pages, £22.95. ISBN 0 13 164203 0

MS-DOS User Book by Simon Lucy. Published by Sigma Press/John Wiley, 117 pages, £6.95. ISBN 0 905 104 81 1

Programmer's Guide to MS-DOS for the IBM PC by Dennis N Jump. Published by Reston/Prentice-Hall, 244 pages, £18.35. ISBN 0 8359 5655 5

Programming the IBM PC & XT: A Guide to Languages by Clarence B Germain. Published by Brady/Prentice-Hall, 340 pages, £22.95. ISBN 0 89303 783 4

Handbook of Basic for the IBM PC by David L Schneider. Published by Brady/Prentice-Hall, 500 pages, £22.95. ISBN 0 89303 506 8

Fancy Programming in IBM PC Basic by Gabriel Cuellar. Published by Reston/Prentice-Hall, 270 pages, £20.65. ISBN 0 8359 1860 2

The Super Computer Snooper by Isaac Malitz. Published by Reston/Prentice-Hall, 184 pages, £17.20. ISBN 0 8359 7148 1

IBM PC Statistics by Charles W McNichols. Published by Reston/Prentice-Hall, 340 pages, £19.50. ISBN 0 8359 3014 9

Computer Playground IBM PC by M J Winter. Published by Datamost/Prentice-Hall, 128 pages, £11.45. ISBN 0 8359 0827 5

IBM PC Conversion Handbook of Basic by J M Harris and M L Scofield. Published by Prentice-Hall, 165 pages £17.20. ISBN 0 13 448481 9

Animation Games and Sound for the IBM PC by Tony Fabbri. Published by Prentice-Hall, 190 pages, £22.45. ISBN 0 13 037689 2

Graphics Programming on the IBM Personal Computer by J Edward Volkstorf. Published by Spectrum/Prentice-Hall, 300 pages, £19.50. ISBN 0 13 363193 1

Computer Graphics for the IBM Personal Computer by Donald Hearn and M P Baker. Published by Prentice-Hall, 330 pages, £21.80. ISBN 0 13 164327 4

Microcomputer Graphics for the IBM PC by Roy E Myers. Published by Addison-Wesley, 268 pages, £12.95. ISBN 0 201 05158 3

Business Graphics for the IBM PC by Nelson Ford. Published by Sybex, 260 pages, £17.95. ISBN 0 98588 124 1

Controlling Financial Performance by D P Curtin, J R Alves and A K Briggs. Published by Business Books, 167 pages £11.95; disc £20. ISBN 0 09 154361 4

Planning and Budgeting by D P Curtin, J R Alves and A K Briggs. Published by Business Books, 137 pages, £11.95; disc £20. ISBN 09 154381 9

Business Decision Making by W R Osgood and J F Molloy. Published by Business Books, 150 pages, £11.95; disc £20. ISBN 0 09 155921 9

IBM PC Assembly Language Programming is Fun and Easy by Samuel A Solomon. Published by Reston/Prentice-Hall, 238 pages, £19.50. ISBN 0 8359 3032 7

8086/88 Assembly Language Programming by Leo J Scanlon. Published by Brady/Prentice-Hall, 213 pages, £18.35. ISBN 0 89303 424 X

8086/8088 Assembly Language Programming by Bik Chung Yeung. Published by John Wiley, 265 pages, £9.95. ISBN 0 471 90463 5

assembler aimed at a more experienced reader than Solomon's work, and comes with some examples of code for standard applications like bubble sorts and ordered list processing.

Bik Chung Yeung's *8086/8088 Assembly Language Programming* is based on the author's experience from running a series of assembler courses, and contains some good original material. Although a quarter of his book concerns the Sirius machine and the accompanying

Microsoft software — which is similar to that used by IBM — users of other hardware are adequately compensated by the extensive and original examples which include a standard I/O library and a communications program. Like other books reviewed here and put together in Britain, it suffers from poor layout, poor artwork and inferior typesetting design. I doubt that even at a relatively low price, this book will attract the sales that it deserves. 

**We start carrying
your workload
the very first day.**



EasyWriter II™ System

EasyWriter II System is word processing that's easy to learn and easy to use. Memos, reports, correspondence, even statistical documents are letter perfect from day one. If you can type, you can use it to lighten your workload.

EasyWriter II System gives you everything you need. It has an 88,000 word spell checker and convenient mail-merge for reports and form

letters. They're built right in, not sold separately. And unlike some other programs you may see, what you look at on the screen is exactly what is printed.

So no matter what your office word processing needs, EasyWriter II System can make the days more productive, by carrying the load right from the start.



**SORCIM/IUS
MICRO SOFTWARE**

A Division of Computer Associates International, Inc.

Easy Software working harder.

Special offer: Free demo diskette

Please send me a Free Demo Diskette* so I can preview the features and effectiveness of EasyWriter II™ System.

Name _____

Address _____

Tel: _____

Post this coupon to:
Sorcim/IUS, 10 Station Road, Watford,
Herts WD1 1EG. Tel: (0923) 46255.

*Diskette is designed for use with IBM-PC® or fully compatible hardware systems. IBM-PC is a registered trademark of International Business Machines Corporation.

Sorcim/IUS Products: EasyWriter 1 System, EasyWriter II System, SuperWriter, Super Calc 3 Rel.2, and other Super Calc Software, EasyFiler, and EasySales Pro.

MM

PC PRICE BONANZA

PROFESSIONAL SERVICE

PROMPT DELIVERY

PC's & COMPATIBLES	EX VAT	PC SOFTWARE	EX VAT
APRICOT PORTABLE 256K 1 x 720K Drive	£1495	CAXTON BRAINSTORM	
APRICOT 256K 2 x 720 Drives & Monitor	£1545	CAXTON CARDBOX	
APRICOT Xi 256K 10MB & Monitor	£2195	DBASE II	
COMPAQ 2 2x360K drives	£1795	DBASE III	
COMPAQ PLUS 10MB	£3195	DMS DELTA	
IBM PC 256K 2x360K Mono	£1865	DMS +	
IBM PORTABLE 256K	£1902	DR FORTRAN 77	
IBM XT 256K Colour	£3217	DR PASCAL	
IBM XT 256K Mono	£2952	DR ASSEMBLER Plus Tools	
MACINTOSH	£1545	FRAMEWORK	
OLIVETTI M24 256KB 2x360KB Drives	£1690	FRIDAY	
OLIVETTI M24 256KB 10MB	£2810	KNOWLEDGEMAN	
OLIVETTI M21 256KB 2x360KB Drives	£1590	LOTUS 1 2 3	
OLIVETTI M21 256KB 2x720KB Drives	£1810	MICROSOFT WORD	

PC PRINTERS	EX VAT
£245 ANADEX DP 6500 500cps	£2234
£165 DRE 8850 300ipm	£2065
£235 EPSON LQ 1500 200cps (NLQ)	£895
£345 MANNESMANN MT180 160cps (NLQ)	£579
£375 MANNESMANN MT400 400cps (NLQ)	POA
£155 NEC 2050 20 cps	£625
£199 NEC 3550 35cps	£955
£280 NEC PINWRITER P2 (P)	£535
£125 NEC PINWRITER P3 (P)	£595
£345 OKI 84A (P) 200cps	£625
£135 OKI 2350P 350cps	£1435
£380 OLIVETTI DY450 45cps (P)	£880
£285 PANASONIC KP1091 120cps + NLQ	£249
£210 QUME 11/55 RO	£1370
£225 RICOH FLOWRITER 1600 8k	£1299
£135 TOSHIBA TH2100H 192cps (P)	£1350
£225 TREND 930 200cps NLQ 80cps	£1350

EXTERNAL HARD DISK DRIVES

PLUS 5 20MB + 5MB CARTRIDGE	£2325
PLUS 5 30MB + 5MB CARTRIDGE	£2845
PLUS 5 40MB + 5MB CARTRIDGE	£3059

IBM MEMORY BOARDS

128K MEMORY EXPANSION	£190
256K MEMORY EXPANSION	£249

PC NET STARTER KIT	£795
--------------------	------

MULTIMATE V 3.2	
MULTIPLAN	
MULTIUSER ACCOUNTS per Module	
OPEN ACCESS	
PEACHTREE	
PEGASUS LEDGER MODULE	
PULSAR LEDGER MODULE	
SAGE ACCOUNTS	
SAPPHIRE DATAMASTER	
SYMPHONY	
TK SOLVER	
VOLKSWRITER DELUXE	
WORDSTAR	

MAYFAIR MICROS

BLENHEIM HOUSE, PODMORE ROAD,
LONDON SW18 1AJ

TEL: 01-871 2555

We accept official orders from UK Government and Educational Establishments. Mail Order and Export Enquiries welcome. Callers by appointment.

NEXT DAY INSURED COURIER DELIVERY AVAILABLE

● Circle No. 171

Superbase 64

TRANSFORMS THE COMMODORE 64 INTO A FULL FEATURED PROFESSIONAL DATABASE SYSTEM, WITH UP TO 1000 CHARACTERS PER RECORD ON UP TO 4 SCREENS... AND UP TO 128 ITEMS PER RECORD, DEFINABLE AS KEY, TEXT, NUMERIC, CONSTANT, RESULT OR DATE, FILE, NUMERIC, CONSTANT, RESULT OR DATE, IN FILES OF UP TO 16M CHARACTERS! SUPERBASE 64 EVEN HAS A SPREADSHEET AND CALCULATOR CAPABILITY, CALENDAR FUNCTIONS, EASY INPUT FROM WORDPROCESSOR OR DATA FILES, BOTH MENU-DRIVEN AND PROGRAM OPTIONS, SORTING/SEARCHING, FULLY DEFINABLE OUTPUTS... SUPERBASE 64 IS ESSENTIAL IF YOU WANT THE MOST FROM YOUR 64! SUPPLIED ON 1541 DISK WITH EXCELLENT TUTORIAL/REFERENCE MANUAL PLUS AUDIO LEARNING TAPE... AND THERE'S A WIDE CHOICE OF "GET-YOU-GOING" APPLICATION STARTER PACKS AT ONLY £9.95 EACH! OUR PRICE £99.95 £88.00

Jetpack

YOUR PROGRAMS WILL REALLY TAKE OFF WITH DTL JETPACK! FULLY COMPATIBLE WITH BASIC, JETPACK COMPILES BASIC PROGRAMS INTO MACHINE CODE, RUNNING UP TO 25 TIMES FASTER AND EVEN USING UP TO HALF AS MUCH MEMORY... AND IT ACCEPTS EXTENDED BASIC AND MACHINE CODE ROUTINES TOO! OUR PRICE (DISK) £39.95 £35.95

FIGARO 64

AT LAST, AN EASY-TO-USE YET POWERFUL NUMERIC DATABASE, WITH A FULL RANGE OF BUILT-IN STATISTICAL FUNCTIONS, PLUS FORECASTING, CALCULATION AND MIXED HI-RES/TEXT GRAPHICS, SUPPLIED ON DISK WITH CLEAR, COMPREHENSIVE MANUAL, FUNCTION-KEY OVERLAY, DEMO PROGRAM. OUR PRICE £86.95 £75.00

Vizawrite 64

VIZAWRITE 64 IS A HIGH-PERFORMANCE, LOW-COST WORD PROCESSOR, WITH ON-SCREEN FORMATTING, THAT TAKES FULL ADVANTAGE OF THE 64'S COLOUR, GRAPHICS AND MEMORY FEATURES... AND SUPPORTS VIRTUALLY ANY PRINTER! WITH A COMPREHENSIVE AND EASY-TO-FOLLOW USER REFERENCE MANUAL, VIZWRITE IS THE ULTIMATE PERSONAL COMPUTER WORD PROCESSOR! AVAILABLE ON CARTRIDGE (£89.95 £78), DISK (£79.95 £68) OR WITH VIZASPELL (£99.95 £85)

*** WANT IT TOMORROW? *** CALL US TODAY! *** ON 01-546-7256

VIZASPELL (DISK)	£59.95	£49.95	MULTIPLAN (US) (DISK)	£29.95	£17.95
VIZASTAR (DISK)	£99.95	£89.00	PRACTICALC (DISK)	£44.90	£39.95
DTL JETPACK (TAPE)	£14.95	£13.95	PRACTICALC (TAPE)	£39.95	£34.95
EASYSRIPT (DISK)	£25.00	£65.00	MASTER 64 (DISK)	£115.00	£64.95
EASYSPELL (DISK)	£50.00	£41.95	THE TOOL (CART)	£49.95	£39.95
SIMON'S BASIC (CART)	£50.00	£41.95	HOMEBASE 1-4 (DISK)	£17.95
ASSEMBLER 64 (DISK)	£24.95	£21.95	PRINTLINK 64 INTERFACE	£29.95

PRICES INCLUDE 15% VAT AND ARE CORRECT ON GOING TO PRESS. ORDER BY POST OR PHONE, USING CHEQUE, ACCESS/BARCLAY CARD OR OFFICIAL ORDER. DESPATCH IS BY SAME-DAY 1ST CLASS POST. PREPAID ORDERS FREE. PRODUCT DATA AVAILABLE ON REQUEST. REF A30



Calco Software

LAKESIDE HOUSE, KINGSTON HILL, SURREY, KT2 7OT. TEL 01-546-7256

● Circle No. 161

OXSTAT

PUT STATISTICS AT YOUR FINGERTIPS

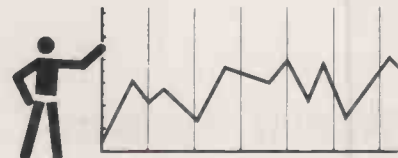

OXSTAT is the first data base manager designed specifically for the research environment. It combines the simplicity and convenience of a spreadsheet data editor with the power of a sophisticated data analysis package. Because OXSTAT is a dedicated system no user programming is required which means results are available fast even to those new to micro-computing. For the more experienced OXSTAT's ability to expand and accept customized user modules offers virtually unlimited horizons.

FEATURES

- * Large Matrix with Spreadsheet screen Editor.
- * Menu driven no complicated command routines.
- * Data input validation.
- * Common statistical tests built in parametric, nonparametric & multivariate.
- * Missing values appropriately handled.
- * Disc storage of data data once entered stored for future use, editing or manipulation.
- * Rapid data analysis matrix under test always held in RAM.
- * Batch mode automatic processing built in.

APPLICATIONS

- * Pure Science Chemistry, Physics, Biology, Genetics Etc.
- * Social and Political Science population analysis, voting trends, economics.
- * Teaching administration, computer science, maths.
- * Medicine research, patient care.
- * Advertising & Marketing survey analysis, sales performance.
- * Instrumentation batch analysis of remotely acquired data.
- * Industry R&D departments, production engineering, process control.

WHATEVER YOUR NEEDS —

OXSTAT PROVIDES THE ANSWERS

Available on any CP/M, MS-DOS, or CP/M-86 based micro.

Details from —

Wallingford Computing Services Ltd.
72, Brookmead Drive, Wallingford, Oxon, OX10 9BJ
Telephone (0491) 35959

● Circle No. 173

EasySales Pro™ picks your best prospects instantly.

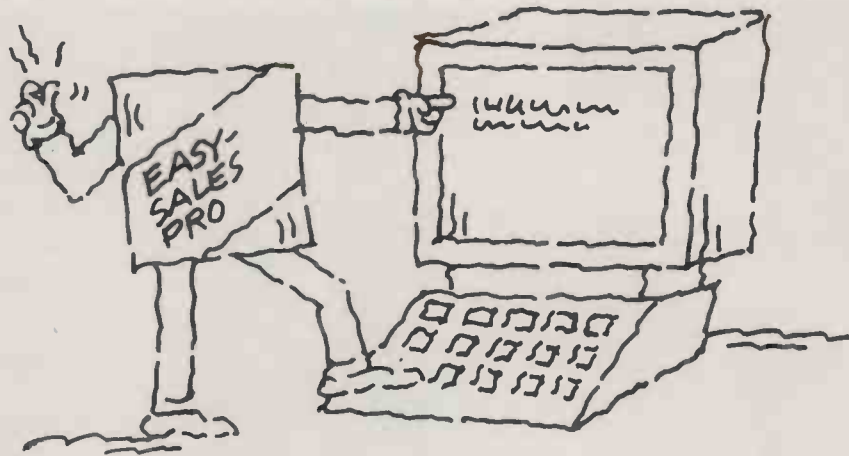

EasySales Pro™

The more accurately you pick your best sales prospects, the more time you save. Your sales force spends more time selling, less time figuring out who to sell to.

EasySales Pro is a personal computer program that can dramatically increase the efficiency of your sales efforts. In one easy-to-learn program, EasySales Pro sets up sales call priorities by ranking the importance of your prospects. It shows you how much time should be spent with them, and how often to call.

Just tell EasySales Pro about your customers and prospects. The pro-

gram guides you to better sales decisions.

EasySales Pro is designed to be adaptable to a wide variety of sales management systems, so you can easily customize it to your product line. And EasySales Pro can generate timely reports on territory activity, as well as in-depth records of prospects. This makes it a snap to update your sales and prospect information.

Pick your best prospects... before your competitors do. Pick up EasySales Pro at any Sorcim/IUS dealer.



SORCIM/IUS
MICRO SOFTWARE

A Division of Computer Associates International, Inc.

Easy Software working harder.

Special offer: Free demo diskette

Please send me a Free Demo Diskette* so I can preview the features and effectiveness of EasySales Pro.™

Name _____

Address _____

Tel: _____

Post this coupon to:
Sorcim/IUS, 10 Station Road, Watford,
Herts WD1 1EG. Tel: (0923) 46255.

*Diskette is designed for use with IBM-PC® or fully compatible hardware systems. IBM-PC is a registered trademark of International Business Machines Corporation.

Sorcim/IUS Products: EasyWriter 1 System, EasyWriter II System, SuperWriter, SuperCalc 3 Rel.2, and other SuperCalc Software, EasyFiler, and EasySales Pro.

AT LAST... THE AFFORDABLE ROBOT.

The Zero 2 Robot has arrived. It's the first truly micro robotic system available and remarkably it costs less than £100.

Controlled electronically through a cable from your computer, it is equipped with wheels, pen, line follower and two tone horn. It will connect easily with the Spectrum, BBC B, Acorn, Commodore 64 and all other personal computers with a standard 'D' type RS 232 connector.

The Zero 2 Robot will add a new dimension to your computer. It is capable of precision movement to accuracies of 1mm and can be fitted with bump and hole sensors.

As a teaching aid it has endless applications and for P.C. users at home it's just great fun.

With additional software and some exciting new add-ons planned for later this year, the Zero 2 Robot will open up a whole new area of applications and games.



INTERGALACTIC ROBOTS LTD.,
UNIT 208, Highbury Workshop,
22 Highbury Grove, London N.5.

Please send me a free information pack.
INTERGALACTIC ROBOTS LTD., UNIT 208, Highbury Workshop,
22 Highbury Grove, London N.5.

Name _____

Address _____

PCI

CAC not CAL

P A S Craddock asserts that those scarce micros in primary schools should be used first and foremost to encourage creativity.

WHEN YOU face a class of 10-year-olds who sit waiting for their group's turn to go to the computer, you realise how inadequate the supply of hardware for schools is. The need for more resources is clear, for with children eager to learn and eager to use computers to help them, one precious afternoon a week computer session is pitifully little.

Computers in primary schools are becoming like old clothes: no novelty but comfortable and well used. Yet interest in computers is still growing. Computers are no longer wonder machines, but a fact of many lives as the number of home computers increases and children become more used to the sort of fare that their machine can offer. However, unless the software offered in schools can be as interesting and compulsive as that used in the home there is a danger of souring the machine educationally in children's eyes.

Three kinds

For the most part, educational software comes in three kinds: drill and practice of specific skills, topic-generating programs and applications software, all of which have their place in the classroom. In addition, there are administrative management programs which are extremely valuable for a school-office computer.

Much rubbish has been written about drill and practice. These programs have been subjected to descriptions such as "soul destroying", "over repetitive" and "of little value". Even the humble drill and practice programs have their place.

Drill and practice using the computer has been, and will continue to be, important in schools. It is often one of the best ways for a child to practise a particular skill, and is often sought by teachers. The computerised work card gives a child a unique opportunity to work at an easy, personal pace, and frees the teacher to employ his or her professional skills elsewhere. It is also a useful type of program to reinforce concepts which have been taught recently. That is not to say there are not serious limitations upon its use, the chief one being that only one or two children at a time may use the computer.

The application program — the content-free utility — has a usefulness all of its own. Much excellent work, especially of an analytical kind, can be carried out using databases. Often this can teach children the limitations of the computer. For example, does its screen-handling facilities allow them to display information easily and sensibly? A computer

screen is also a source of many pitfalls; does the machine automatically columnise decimal values, for instance? If children want to use $5\frac{1}{2}$ instead of 5.5, can they? Things of this kind are as useful to the child in a learning situation as the content of the database itself.

Word processing is of similar use. Not only can word processors be used for providing a good display of other work, they can be useful as an aid to confidence if a child has difficulty in getting words on to paper but is otherwise full of ideas.

Utilities can provide many sorts of constructive work, but do not draw particularly heavily on a child's creativity. This is where the other sort of program comes into its own. You can purchase a number of programs which can be used by a teacher to enrich a classroom environment by providing a stimulus that is wide ranging and interesting.

The word "topic" in schools is one that has many meanings to many people. I feel that this is the most exciting area of the curriculum into which the computer has moved, and many good programs already exist of this type. It is certain that more will be becoming available on a variety of machines. Those already in existence include certain of the Dudley Programs such as Spacex, Granny's Garden and Argonaut, all for the BBC model B. Quite a large number of games and adventure programs also fall into this category. The BBC model B and the Spectrum are in the forefront at the moment, but similar programs will be available for the Amstrad and other machines.

Topics made exciting

Such programs provide a teacher with a base for stimulating the imagination of children, and through it their creativity. In primary schools there are endless possibilities in terms of artwork, creative writing and so on. The programs are designed to produce various spin-offs. By using them the child enters the world of computer-assisted creativity, where what is going on in the machine is able to stimulate the essentially human ability to expand the consciousness to take in a whole range of imaginative concepts. Thus, a comparatively brief exposure to a computer can often have a disproportionately useful

effect on a child's work and thinking.

The value of this to a teacher is impossible to overestimate, for if children find such a program interesting they will actually want to develop further the ideas offered to them. A typical response to such work is "Could we write our own program like this about. . .", and out comes another area of interest the children may have. Unfortunately it is not usually possible for children to actually write such a piece of code, because the complexity of what goes on deep in the machine escapes them. But it is a slow-thinking teacher who does not pounce on this spontaneous desire to be creative and channels it down other constructive paths. Another likely response is "What if X did Y instead of Z?" If the program itself does not provide an answer, then there is yet another channel for the teacher to encourage the child to explore.

Work and play

Simulation programs which fall within this category are especially useful for exploring all kinds of What-If? situations. Many teachers have used Oil Slick or The Mary Rose to good effect, and a skilful teacher can often get work out of games such as Taipan and Forest Fire that lasts for many weeks before all the possibilities are exhausted. Much of this work goes beyond the factual and into the realm of imagination. It is interesting to see the different levels that a class of children can work on simultaneously with only quite short sessions at the machine itself.

Much educational thinking about computers is that they should be a normal classroom resource. This is a sound idea, but will not come to fruition until a lot more machines are available. The shortage of machines is offset to some degree by programs that only require short exposure to stimulate activity. There is little that can be done to increase the numbers of machines that a school can afford. The government's pound for pound scheme can only provide one machine per school when we should really be thinking of one machine per class, and money gets tighter year by year.

So it is necessary to get the most possible out of a machine, which suggests that the more spin-offs a computer session can generate the better the use to which it is being put. If teachers lean towards computer-assisted creativity — CAC rather than CAL — then the typical single computer session per week might provide sufficient material to last until the next one.

P A S Craddock is in charge of Computer Studies at Bluecoat Junior School, Walsall, and a former member of the microelectronics team at Walsall Education Development Centre.

Telephone Lucy O'Sullivan 01-661 8163

ADVERTISEMENT RATES

Copy Date

Display Rates

£16.50 per single
Column Centimetre
Minimum 5cm x 1 col
One Insertion : £16.50 per scc
Three Insertions : £15.75 per scc
Six Insertions : £15.50 per scc
Nine Insertions : £15.00 per scc
Twelve Insertions : £14.50 per scc

Micro Ads.

Lineage 30p per word minimum of 20 words.
Prepayable.

Shopwindow advertisements for the June edition will be accepted up to 25th April subject to space being available.

Post to

Practical Computing, Classified
Department, Room H211, Quadrant House,
The Quadrant, Sutton, Surrey SM2 5AS.

REALISE YOUR FULL POTENTIAL LIFE-LINE



SELF ANALYSIS CAREER COUNSELLOR

FOR ANY SPECTRUM COMPUTER
(IBM64 and BBC coming soon)

Understand yourself and others using this brilliant new programme!
LIFE-LINE will reveal:

- YOUR TRUE CHARACTER
- THE CHARACTER YOU TRY TO PROJECT
- YOUR SELF-IMAGE

LIFE-LINE can help you:

- CHOOSE THE RIGHT CAREER
- ACHIEVE MORE
- UNDERSTAND OTHERS
- IMPROVE YOUR RELATIONSHIPS

LIFE-LINE is simple to use, amazingly accurate, and comes complete with an instruction manual written by St. John A. R. Young B.A. (Psych).
LIFE-LINE is designed for use in the home, school or college - anywhere that people matter.

Price £14.95 inclusive of VAT and Postage.
All enquiries SAE please.

Barclay Access orders accepted by telephone.

WILLIAM STUART SYSTEMS Ltd
Quarley Down House, Cholderton
Nr Salisbury, Wiltshire SP4 0DZ
Tel: 098 064 235

● Circle No. 300

SCIENTIFIC SUBROUTINE LIBRARY

VOLUME 1 - STATISTICS AND FITTING FUNCTIONS
Mena, SD, normal distribution, partial expectation, Chauvenets criterion, least squares fit to polynomial and arbitrary function, repetitive least squares fits, covariance matrix, chi-squared statistic, matrix inversion, solution of linear simultaneous equations.

VOLUME 2 - LINEAR PROGRAMMING
Reduction of a simplex tableau, integer programming, partial integer programming, conversational linear programming system, least cost mix problem.

VOLUME 3 - FURTHER STATISTICS
Ranking, quantiles, frequency, correlation coefficient, T, chi-squared and F distributions and their inverses, T test, chi-squared test, Wilcoxon test, linear and multiple regression, ANOVA 1-way and 2-way.

VOLUME 4 - TRANSFORMATIONS AND SORTING ALGORITHMS

Fourier and Fast Fourier transforms, numerical integration and differentiation, harmonic analysis, interpolation, coordinate transformations. Exchange sort, Quicksort, Shellsort, Tree sort.

All routines are written in BASIC for easy implementation on any machine.

Machine readable source code £75 - VAT per volume (Most disk formats + QL microdrive now available)
Manuals including full source listings with implementation notes and documentation £25 per volume

CP/M TO DEC FILE TRANSFER

Software to read and write RT-22 format RX01 diskettes under CP/M. Supplied on 8" SSSD diskette - £25 + VAT.

SINCLAIR QL TERMINAL EMULATOR

Allows the SINCLAIR QL to act as a terminal to connect to other micros, bulletin boards and mainframes - £25 + VAT
Write or phone for further information on any of ur products.

MICRO LOGIC CONSULTANTS LTD.

57 Station Rd., Southwater, Horsham, W.
Sussex RH13 7HQ
Telephone 0403 731818

● Circle No. 301

Tele Video Multiuser Equipment Secondhand in excellent condition

- i. T.S. 816/40 £5,600
- ii. T.S. 806/20 £2,100
- iii. T.S. 806/10 £1,900
- iv. Sirius Act 1 £1,200

Cambridge Data Ltd

15 Margaret St., London W1N 7NE
01 580 1654
8, Musters Rd.
West Bridgeford,
Nottingham NG2 7PL
0602 811801

78

● Circle No. 302



MICROMODS LTD.
53 ACTON RD., LONGEATON, NOTTINGHAM
NG10 1FR. Tel: 0602-724264

32

● Circle No. 303

GENIE OWNERS

Don't sell your Genie!!
Upgrade it to latest spec.

Hi-Speed CPU - 3.8MHz £34.95
All programs run up to 60% faster.

Lowercase - £34.95
Full UPPER/lower case.

TAB/CLEAR keys £6.95

Plus many other **hardware** items ring for ANY hardware or **repair** quote.

ARC Electronics, Wakefield, Yorks.
WF2 6SP. (0924) 253145

67

● Circle No. 304

OPEN HOUSE TUITION FOR NOVICES AND OTHERS

Choose your time - day or evening
Learn at your own pace.

BASIC programming £60
BUSINESS Packages £70
Word-Processing introduction £25

Brochure from:

MICROCOMPUTER ADVISORY CENTRE,
Polytechnic of the South Bank,
Borough Road,
London SE1 0AA

or ring:
01-928 8989 ext. 2468

58

● Circle No. 305

Quality products at low prices

Thermal Paper
Alphacom 32 £7.00/5 rolls
Alphacom 42 £7.00/5 rolls
HP models available

Listing paper (2000 sheets/box)
11" 9.5" plain 60gsm £12.50
11" 8.5" plain £12.00

Floppy Disks
5.25" CDC Dyson Maxell
SS/SD £16.00 £20.00 19.00
SS/DD £22.50 £30.00 £29.00
QS/DD £26.50 £34.00 £33.00

Price includes VAT
Please add p&p £3.00/box for paper & £2.00 for any quantity of disks.

Cheques & p.o. to 'DESKFLAIR'
DESKFLAIR
71 Woodlands Rd., Hertford SG13 7JF
phone (0992) 558258

● Circle No. 306

BEST PRICE/PERFORMANCE COMPLETE BUSINESS COMPUTER SYSTEM

FOR
£1195.00
THE COMPLETE BUSINESS PACKAGE

NEC PC-8000
NEC 2 MEGABYTES DISK STORAGE
NEC 14" HIGH RESOLUTION COLOUR MONITOR
NEC 120 c.p.s. PRINTER incl. 2 K BUFFER
NEC 64K CP/M COLOUR COMPUTER
NEC DETACHABLE KEYBOARD
NEC ALL CONNECTING CABLES
NEC NBB BASIC & N BASIC SOFTWARE
ALL ABOVE FOR £1195.00 + VAT

SOFTWARE: ACCESS - RETAIL, WHOLESALE
POINT OF SALE. SAGE ACCOUNTS & PAYROLL
WORDPROCESSING. BUNDLED SOFTWARE:
WORDSTAR + MAILMERGE + MULTIPLAN

£195.00
ACCESS COMPUTERS

2 ROSE YARD MAIDSTONE KENT. ME14 1HN
TEL (0622) 58356

● Circle No. 307

KINGSLEY ENTERPRISES

Specialists in all kinds of floppy diskettes
Mail Order Discs

Prices are for boxes of 10 discs

Soft Sector	Nashua	Xidex	Dysan	Centech
5.25" Diskettes				
SS/SD 48	15.00	-	-	-
SS/DD 48	16.00	18.00	19.00	19.00
DS/DD 48	18.00	23.00	26.00	24.00
SS/DD 96	23.00	30.00	26.00	25.00
DS/DD 96	23.00	30.00	33.00	31.00
8" Diskettes				
SS/SD 48	20.00	-	25.00	-
SS/DD 48	21.00	22.00	26.00	29.00
DS/DD 48	22.00	26.00	30.00	33.00

Sony 3.5" (Apricot) Diskettes £36.00

Post Paid. Add VAT at 15%

Prices correct at time of going to press
Please ask for details of hard sector discs,
business/educational accounts
discounts, formatting.

KINGSLEY ENTERPRISES
87 Whitefield Road
Stockton Heath
Warrington
WA4 6NB

35

*Organise your files on
Centech Colour
discs*

● Circle No. 308

MICROCOMPUTER INSURANCE

Comprehensive cover at a reasonable premium:

- All Risks Cover (incl. Transit) — up to £10,000 for £20
- Increased Cost of Working — up to reinstatement lost data
- Breakdown & Derangement — alternative to maintenance agreement

Write with details to:

Geoffrey Hoodless & Associates
Freepost (no stamp required)
Woking
Surrey GU21 4BR
Tel: Woking (04862) 61082 (24 hrs)

71

● Circle No. 309

FORTH = TOTAL CONTROL

FORTH 83 — Professional FORTHS from Laboratory Microsystems. Screen editor, assembler, utilities, full documentation. Special version for IBM PCs and 100% compatibles. State disc format with order. CPM-80 £95+VAT, CPM-86/MS/PCDOS £190+VAT.

QL FORTH-83 — screen editor, macro-assembler, decompiler, turnkey compiler, binary overlays, floating point, colour, graphics, sound, 'hash cache' fast compiler, and 70 page manual — £29.95.

NEWBRAIN FORTH in PROM — includes screen editor, full integration to NEWBRAIN ilo handlers, Z80 macro-assembler, floating point, graphics, decompiler, utilities, and manual — £51.75.

DRAGON FORTH cartridge — split screen editor, sound colour, decompiler, overlays, joystick and timer support, full documentation, and complete source code — £35. CoCo version £45.

Do-it-yourself FORTH. Installation manual — How to do it, model, definitions, editor — £7. Source code: 6502, 6800, 6809, 8080, Z80, 8086/8088, 9995, 1802, 68000, Z8000, VAX, Apple II, LSI-11 — £7 each.

Implementations for Spectrum to VAX, and a range of FORTH books.



MicroProcessor Engineering Ltd
21 Hanley Road Shirley
Southampton SO1 5AP
Tel: 0703 775482



● Circle No. 310

compare
northern
computers...
considerate,
competitive
and
committed!

THE Showroom for all the leading micros

◆ BBC ◆ Electron ◆ Sinclair ◆ VIC64
◆ Dragon ◆ Printers ◆ Disk Drives
◆ Plenty of Software
◆ Books/Games ◆ Help & Advice
◆ Secondhand Computers

Churchfield Rd
FRODSHAM Ches
WA6 6RD

**northern
computers**

Telephone:
FRODSHAM
0928 35110
10 Lines

THE computer centre of the NORTH

● Circle No. 311

Set your
micro free!

WITH HARDWARE

Data Buffers

Don't wait for printing to finish — no matter how fast your printer, your computer works faster.

Release that micro for more processing, seconds after giving the command to print out.

Save time by using a data buffer. And remember, computer time saved means operator time saved.

Word-processing and all print-orientated tasks can be speeded-up dramatically.

Graphics and CAD output — a data buffer is a must for these applications.



Cost-effective time saving. From £87.50 for 16K of buffer memory (for use with Epson printers). 64K buffer memory with optional serial or parallel input or output £199. Full-featured (copy, output hold, etc) 256K buffer memory, £423. Prices exclude VAT. Trade, quantity, and corporate terms — please call.

A>Line Computer Systems MICRO BUFFER DISTRIBUTORS

1 Church Farm Lane,
Willoughby Waterleys,
Leicestershire, LE8 3UD.
☐ Peatling Magna (053 758) 486

89

● Circle No. 312

GRUNDIG KINGSLEY

104 Heaton Road,
Newcastle-upon-Tyne NE6 5HL
Tel: (0632 650653)



R.G.B. MONITOR/TELEVISION

AS SUPPLIED TO EDUCATION AUTHORITIES
SPECIFICATION

R.G.B. Inputs (Analogue and Digital Levels) All Models.
1 Volt P.P. Composite Video (Remote Model only)
Teletext Decoder available to plug into Chassis. (Remote Model only) Sound input gives access to Audio Amp.
All Models instantly switch back to Television

12" B.W. Monitor	£70+VAT
14in. Colour Monitor/Television	£227+VAT
16in. Colour Monitor/Television	£255+VAT
16in. Colour Monitor/Remote Television	£295+VAT
20in. Colour Monitor/Remote Television	£315+VAT
22in. Colour Monitor/Remote Television	£340+VAT
26in. Colour Monitor/Remote Television	£380+VAT
Plug in Teletext Module	£75+VAT
Connecting Lead	£5+VAT
Carriage and Insurance	£9.50
4 Year Guarantee Insurance	£29.60
R.G.B. Monitor/TV (Grundig Approved)	35

● Circle No. 313

READ AND PRINT BAR-CODES USING ANY COMPUTER

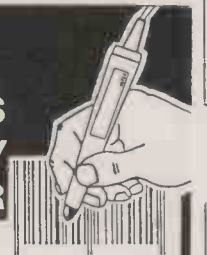

Bar-codes give a speedy and error free means of data entry and provide a foolproof method of identification for any item or document. Typical uses include stock control, libraries, filing systems, security and checkpoint verification, point of sale terminals, spare parts identification, etc. etc. Already most grocery products are bar-coded at source and many other areas of industry and commerce are following. Bar codes will soon be commonplace. Atek decoding algorithms have been developed over a period of years and are recognised as being second to none. (Others use our software under licence, in their own products.) All easily exceed the industry standard benchmarks. (90% first time read and one substitution error per million reads) All Atek decoders are housed in a smart instrument case with "ink-well" for the scanning wand when not in use. In addition they all come with software to print bar codes on a standard dot matrix printer. (Epson or compatible). A complete bar code identification system at minimal cost.

RS232 Bar-code Reader
This microprocessor based unit decodes the bar-code and converts it into ASCII for transmission to the host via a RS232 port. Complete with power supply and cables. Works with virtually any computer. Baud rate, data format and optional check digit verification selectable with DIL switches. £385.00 + VAT

NEW system for BBC micro
ROM based, interrupt driven software. Switch on and read bar codes! Nothing to load, no commands needed to start. Reads alphanumeric codes at power up and automatically inserts the data into the keyboard buffer so it is possible to control the computer entirely via barcodes! Decodes ALL these formats: EAN13, EAN8, UPC-A, CODE-39 & INTERLEAVE 2/5. As supplied to Acorn. £249.00 + VAT. CBM/PET & APPLE 2

Lowest cost system. Disk based software decodes the bar code format of your choice and is easily interfaced to BASIC or Assembler. A full specification bar code identification system as used by many private & public sector laboratories, industrial & commercial organisations. £199.00 + VAT. (Not suitable for Apple running CP/M... Use RS232 system!)

Phone or write for further details. Please state area of interest and what computer is to be used. We are also franchised distributors of Systel bar-code products & wands in the UK.

62

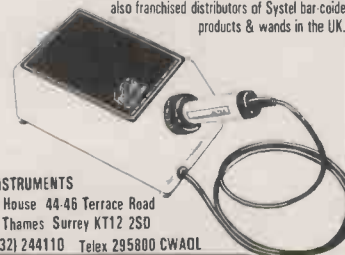

ALTEK INSTRUMENTS
Enterprise House 44-46 Terrace Road
Walton on Thames Surrey KT12 2SD
Phone (0932) 244110 Telex 295800 CWAOL

SHOP WINDOW

Every computer needs
CHATTERBOX II
"Listen creep, I am the leader....."

For ZX81
SPECTRUM
BBC
TRS 80
APPLE
NASCOM
VIC/PET/64
(Please state)

NEW!
EXCLUSIVE! **PITCH CONTROL**

CHATTERBOX II can say anything!

Genuine phoneme synthesis - not just recorded speech - hence unlimited vocabulary. Programmable pitch for more natural intonation (exclusive to Wm Stuart Systems) - solid tone cabinet for quality sound - integral beep/music amplifier. PLUS expansion socket for BIG EARS voice recognition system. Full instructions technical notes and software supplied with this outstanding educational unit.
DEALER ENQUIRIES WELCOME

As seen on BBC TV "Computer Programme"

BIG EARS

SPEECH INPUT FOR ANY COMPUTER



Highly successful Speech Recognition System complete with microphone, software and full instructions.
BUILT TESTED & GUARANTEED
PLEASE STATE COMPUTER: UK101, SPECTRUM, ATOM, NASCOM2, Vic 20, Micron, ZX80/81, PET, TRS80, M280K, APPLE II, BBC MICRO, CBM 64.

ONLY £49

ZX81/SPECTRUM

MUSIC SYNTHESIZER (Stereo) +16 LINE CONTROL PORT

Play 3-part music, sound effects, drums etc. Full control of attack, decay and frequency. Input/Output lines provide control and monitor facility for Home Security, Robot Control, Model Railway etc. Works with or without 16K RAM.

Full instructions/software included. Add keyboard to make a live performance polyphonic synthesiser!
Note: up to 3 units can be used simultaneously; giving 9 music channels & 48 I/O lines

AMAZING VALUE AT ONLY £19.50 (KIT) £25.50 (BUILT)

S
O
F
T
W
A
R
E

THE COMPOSER

Synthesiser Music Programme. Enter & play 3 part harmony includes demonstrations (Spectrum ZX81) recommended £7

TALKING HANGMAN

For Chatterbox! The classic game claims its victims with a dry vocal accompaniment (Spectrum) £6

ZX ARPIDRUMSEQ

Fascinating synthesiser demonstrations. Generates automatic sequences and plays from keyboard. Some weird effects (Spectrum) £6

CHROMACODE?????

Can you defuse the bomb by cracking the secret combination before time runs out? With Chatterbox voice output (Spectrum) £6

COLOUR MODULATOR

RGB in, PAL UHF out (not for ZX)

KIT £16
BUILT £22

Please add VAT at 15% to prices. Buy/Access orders accepted by telephone

All enquiries S.A.E. please

WILLIAM STUART SYSTEMS Ltd

Quarley Down House
Chiddingfold
Nr. Salisbury
Wiltshire SP4 0DZ
Tel: 098 064 235



Are you having **INTERFACE PROBLEMS?**

SOLUTION 1:
SERIAL-CENTRONICS CONVERTER. £59.95 £42.95

For owners of computers with RS232 output who wish to save money on printers. No special software required... totally transparent to computer; needs no external power.

SOLUTION 2:
SERIAL - 4-WAY SERIAL... £59.95 £42.95

For owners of computers with RS232 outputs who wish to talk to four different devices without swapping leads. Needs NO POWER. Supplied with any mix of sockets and leads.

SOLUTION 3:
CENTRONICS - 2-WAY CENTRONICS £59.95 £42.95

For computer owners who wish to drive more than one printer. Add £25 for additional ways. Reverse also possible at same price. Requires no power; includes both printer leads.

SOLUTION 4:
SERIAL - 2-WAY CENTRONICS £84.95 £64.95

For owners of computers with RS232 outputs who wish to connect two (or more) printers and save money on leads and effort on swapping leads, as they are included. Add £25 for additional ways.

Especially suitable for
SINCLAIR QL, SPECTRUM with INTERFACE 1, EPSON HX20 DND PX8, NEWBRAIN, APPLE 2C etc.
Please enquire about our range of software for the NewBrain
All prices include VAT and postage and packing in UK & Europe.
DEALER ENQUIRIES WELCOME

For other solutions, watch this space, or contact us at...
TYEPRO LIMITED, 30 Campkin Road, CAMBRIDGE CB4 2NG
Tel: Day 0255 422087 Eve 0223 322394

● Circle No. 315

We are a wholesaler and producer of peripheral goods for the Commodore C-64 e.g. plastic-covers, music-keyboards, datasets, printer-chassis, etc. We are also a wholesaler of hardware in general.

We are looking for contacts and if your company is a wholesaler with good contacts to your national computer-market please phone us for further information and samples.

Please contact:
SCHMITT-COMPUTERSYSTEME
6101 Brensbach-4, West Germany
Tel: 06161/2039 or Telex 4191941

87

● Circle No. 316

REVOLUTION for APPLE programmers

* Keyboard enhancement for Apple IIe or II+

* Pre-boot disk gives 20 user-definable keys + 37 single stroke functions

ONLY £29.50 + VAT
p&p inclusive for pre-paid orders

Orion Microware Ltd, 60 Longmead
Avenue, Chelmsford, CM2 7EQ.
Tel: 0245 71228

76

● Circle No. 317

data buffers

print buffers T-switches
buffered protocol converters
telecommunications buffers

Formats:
IEEE-488 or Centronics parallel,
or V24/RS232c serial, or any
conversion combination.

Buffer sizes:
From 2k to 1 megabyte RAM.

Computers:
IBM PC, Hewlett-Packard, DEC,
Apple, Sirius/Victor, Televideo,
Super Brain, Commodore, BBC,
Tandy, Sharp, Osborne, NEC,
Data-General, etc, etc.

Applications:
Input buffering (data collection,
telecommunications, etc.).

Output buffering (accounts/payroll printing, plotting, graphics dumps, assembly listings, word processing, telecommunications, etc.).

Support:
We are the leading specialist distributor of UK-designed buffered interfaces, with a range of products second to none in scope, price and reliability.

A-Line Computer Systems
MICRO BUFFER DISTRIBUTORS

1 Church Farm Lane,
Willoughby Waterleys,
Leicestershire, LE8 3UD.
☎ Peatling Magna (053 758) 486

92

● Circle No. 318

6809 CPU CARD

Powerful add-on to your home computer. Quality plated through PCB with full assembly instructions. Full RS232 Serial interface (up to 19,200 Baud). Data storage to cassette (via external CUTS interface). Versatile Parallel interface for Control applications or keyboard and printer. Operation at 1MHz or 2MHz. 2k/8K Static RAM with 2K/8K EPROM or alternatively 4K/16K EPROM (2 sockets). Communications via serial link to your home computer.

Software available: Monitor, Disassembler, Editor/Assembler.
Coming soon: FORTH Programming Language, Floppy Disk Interface, EPROM Programmer and others.

Prices + VAT:
PCB only £29.95; with Monitor £39.95;
Monitor + Disassembler £14.95; Upgrade £5.00;
Mon. + Dis. + Editor/Assembler £34.95;
Upgrade £20.00.

SOLASCAN Micro-Systems Ltd.,
91 Bryanston Rd., Bitterne,
Southampton SO2 7AL
Tel: So'ton (0703) 436224

72

● Circle No. 319

COMPUTER AND PERIPHERAL REPAIR AND SERVICE

Business and Personal
Computers, Printers, VDUs, etc.
Fast Turnround Competitive
Prices

HAMMOND AND MEADES

Unit 10
The Maltings
Stanstead Abbotts, Herts.
Tel. 0920 871624

93

● Circle No. 320

TELEVIDEO EXCELLENT CONDITION

TS 806	£2,300
TS 816	£6,500
TS 800A	£ 900
TS 802	£1,300
	+ VAT

Cambridge Data Ltd

15 Margaret St., London W1
Tel: (01) 580 1654

90

● Circle No. 321

BBC LEVEL II ? ECKNOTTED?

"DISCOVERY II" will retrieve programs and data from scrambled Level II disks and copy files to normal DFS.

For special utilities and troubleshooting for Econet telephone (0705) 812466

2 Queen's Place, Southsea, PO5 3HF
John Billingsley Associates Ltd

● Circle No. 322

SHOP WINDOW

REPAIRS & SERVICE

- * COMPUTERS (Business & Personal)
- * DISC DRIVES (5 1/4" & 8")
- * WINCHESTERS
- * MONITORS
- * VDUs
- * PRINTERS
- * WORKSHOP REPAIR CONTRACTS
- * Fixed repair charges
- * 3 months warranty on repaired part
- * 48 hour service for disk drive alignment

A.N. ELECTRONIC & COMPUTER SERVICES LTD

130B North Lane, Aldershot, Hants
Tel: Aldershot (0252) 25608

68

● Circle No. 323

TANDY MODEL III. 48K twin disk drives, RS-232 built in. Lots of disk based software, £65 o.n.o. Phone 0584 810015. 152M

DATA LOGGER BBC-B SOFTWARE. Interrupt programming allows choice of display while measurements continue. High speed assembler. Supports 4ADUAL channels from 1/10 second. Pulse counting pin6 user port. Two point calibration. Graphs linear, log, complex function, superimposed. Save screen to disc. Spool data, etc. 40-track disc, £10. Stainton Hall, Stainton, Kendal LA8 0LQ. 153M

BOARD REPAIRS BY JAE CROW. With our new automatic test equipment, we are able to locate PCB faults fast, both UK and overseas. Ring 01-680 9191 for full details, without obligation. Jaecrow Systems Services, 29/31 Lower Coombe Street, Croydon, Surrey CR9 1LX. Quote ref: PC 485. 136M

QL PLUS EXTRAS. Centronics printer interface, extra cartridges, RS-232/monitor leads. Virtually unused (second computer), £365 o.n.o. Tel: 06633 2074. 146M

ORYX PROJECT. Programmers wanted London area, to join new arts based educational software project. Ring 01-670 6996, office hours 147M

TRS-80 MODEL 4 128K, integral screen, dual drives. Line printer. Multiplan Superscript Profile Visicalc games utilities DOSS etc. Ideal for small business, £950 o.n.o. 0306 711408 148M

NEW TORCH ZDP double-sided 80-track disc drive for BBC. Z80 board with extra 64K RAM. M-Tec Z80 BBC Basic. Perfect Calc, Writer, Filer, £625. 092-82-2929. 149M

SHARP MZ-700 and MZ-711 owners. Brand new and original programs for sale. S.a.e. for complete list by return to: Maysoft (DMB), 50 Thompson Avenue, Colchester, Essex CO3 4HW. 150M

CP/M USER GROUP disk libraries. 300+ volumes. Copying fee £1.50. Disk format translation £6.50 inc. Most formats. S.a.e./phone R. Smith, 138 Holtye Road, E. Grinstead, Sussex RH19 3EA. 0342 313893. 151M

DISK COPYING SERVICE

Moving data and program files from one machine to another is often made difficult because different manufacturers have adopted different disk format standards.

We can copy your files to and from over 250 disk formats including CP/M, CP/M-86, MS-DOS, PC-DOS, ISIS, APPLE, SIRIUS, TORCH, APRICOT, HP150, DEC RT-11, and IBM BEF.

Disks are normally despatched on the day they are received.

Our charge is £10.00 + disk + VAT. Special prices for quantities.

For more information call us.

GREY MATTER

4 Prigg Meadow, Ashburton, Devon TQ13 7DF.
TEL. (0364) 53499 10

● Circle No. 324

When replying to Classified advertisements, readers are recommended to take steps to protect their interests before sending money.

SELL IT WITH

Practical Computing

SHOP WINDOW

MICRO ADS. Order Form

Classified Rates

Lineage 30p per word
Minimum 20 words prepayable.

Display Adverts.

Rate per single column
Centimetre: £16.50
Minimum 5 cm
SERIES Discounts
Available on request.
Contact: Claire Notley on
01-661 8163.

Method of Payment

Cheques etc should be made payable to BUSINESS PRESS INTERNATIONAL LTD. and crossed. I enclose herewith cheque/PO for

£.....

Post to:

Cut out the order form and return together with your remittance to:
Classified Department,
Practical Computing,
Room H211, Quadrant House,
The Quadrant, Sutton,
Surrey SM2 5AS.

Conditions of Acceptance

Micro Ads are accepted from Private readers only and must be submitted on (or a photocopy of) this order form. All Advertisements must be prepaid.

Please insert the following advertisement in Practical Computing

Please insert the following advertisement in Practical Computing				LINAGE	
				Cost per insertions	
				1 Ins. ✓	2 Ins. ✓
				£6.00	£5.50
				£7.50	£7.00
				£9.00	£8.50
				£10.50	£10.00
				£12.00	£11.50
				£13.50	£13.00
				£15.00	£14.50

Box No. Required YES/NO

✓ tick number of insertions required

NAME (Please include initials)

ADDRESS

THIS FORM SHOULD BE RETURNED BY 25TH APRIL FOR THE JUNE ISSUE

Company Registered Number: 151537 (ENGLAND). Registered Office: Quadrant House, The Quadrant, Sutton, Surrey SM2 5AS.

THE SOFTWARE WAREHOUSE

MICRO FOCUS Professional COBOL for the IBM PC (+ 100% Compatibles) the XT, AT and 3270 PC running DOS 2 (or higher). Includes FORMS, ANIMATOR, SCREEN EDITOR, BUILD and LIBRARY features. Fully supported by MICRO FOCUS.

RRP £225 SWP £1995

MICRO FOCUS High performance Level 11 COBOL.

RRP £1250 SWP £995

MICRO FOCUS Level 11 COBOL.

RRP £965 SWP £758

OTHER PRODUCTS SELECTED FROM OUR RANGE

	RRP	SWP		RRP	SWP
D BASE 11	£365	£240	FRAMEWORK	£495	£330
D BASE 111	£495	£325	WORDSTAR	£295	£195
FRIDAY	£195	£130	WS PROFESSIONAL	£495	£330
OPEN ACCESS	£450	£300	MULTIMATE	£339	£225
OZ	£330	£220			

SUPERCALC 3.2

RRP SWP
£295 £225

SENSIBLE SOLUTION

Single User

£565 £460

S/User RTS

£160 £130

Multi User

£800 £650

M/User RTS

£265 £215

PLEASE ENCLOSE PAYMENT WITH ORDER

Add 15% VAT to above prices. Post and packing £2.

THE SOFTWARE WAREHOUSE

9 Laponum Walk, Yeading, Hayes, Middx. UB4 9PN.
Tel: 01-841 1209

CONSULTANCY, PROGRAMMING AND TRAINING
SERVICES AVAILABLE

DON'T VAT THE PRESS

There are strong reasons to believe the Chancellor of the Exchequer is planning to impose VAT on your magazine.

Such a move would turn the clock back 130 years — the last tax on newspapers and journals was repealed in 1855. Since then 'No tax on knowledge' has been a principle agreed by all Governments, even in the darkest days of war.

A free Press is a tax-free Press.

No Government should be given the power to impose financial pressure on a Press it may not like.

Tell your MP to say 'NO' to any tax on reading.

Issued by the Periodical Publishers Association, London

● Circle No. 175

PRACTICAL COMPUTING

Advertisement Index

A	A + G Computer Ware 22	D	Data Products 56	K	Keele codes 82	Q	Quest International Computer Systems Back cover
Akhter Instruments 58/59	D	Data Marketing Ltd 49	Dennison Mfg inside front cover	L	Lantech Information Systems 120	Research Machines Ltd 38/39	Rosco Ltd 164
Albeta Ltd 121	D	Digithurst Ltd 114	Digitask Business Systems 147	L	L&J Computers 36	R	
Alpha Microsystems 45	D	Duplex Systems Ltd 64	E	M	Mayfair Micros 170	S	Sagesoft Ltd 20, 34, 140/141
AMA Computer Supplies 155	E	Electronequip 83	ESC Publishing 166	Mercator Computer Systems 120	Micro Computer Disks 166	Sinclair Research 67/68/69/70/71/72/73/74	Smith Corona 17
Ampex GB Ltd 25/26/27	E	Etafield 162	F	Micro Planning Software 55	Micro Peripherals Inside back cover	Soft Option Ltd 102	Software 85 Exhibition 98
Amstrad 18/19	F	Folly Micro 48	Fraser Associates Ltd 155	Micro Processor Engineering Ltd 44	Micracle Technology 46	Southdata 6	Sorcim 165, 169, 171
Anglia Computer Centre 65	F	Fujitsu 91	G	Microvitec PLC 124	Microft Technology Ltd 162	Software Warehouse 178	Systems C 4
Associated Book Publishing 54	G	GCC (Cambridge) 62	Gemini Microcomputers Ltd 145	Microware 152	Mountandene 134	System Science 23	T
Association of London Computer Clubs 14, 134	G	GW Computers 51	H	Microprocessor Engineering Ltd 44	Micracle Technology 46	TABs 47	Tailored Business Systems 52
AWS Computer Supplies 23	H	Handic Software 63	HM Systems Ltd 42, 139	Microware 152	Microprocessor Engineering Ltd 44	Tandata 24	Tandy 40
B	H	High Technology Ltd 134	Homestead Electronics 44	Microprocessor Engineering Ltd 44	Micracle Technology 46	TDI 138	Telesystems 60
Bolton Insurance Services Ltd 49	I	Informata Ltd 37	Interface Systems 9	Microware 152	Microprocessor Engineering Ltd 44	Thame Systems 50	Torch Computers 122/123
Braid Ltd 87	I	Inter Galactic Robots Ltd 172	Inmac (UK) Ltd 137	Microware 152	Microprocessor Engineering Ltd 44	Triumph Adler 120	Trisoft Ltd 45
Brighton Computer Centre 14	J	Jarogate Ltd 95	Jentech Computer Services 33	Microware 152	Microprocessor Engineering Ltd 44	Triumph Adler 120	Vega Computer Ltd, 158
British Computer Society 156	J	Jentech Computer Services 33	Juki (Europe) GmbH 28	Microware 152	Microprocessor Engineering Ltd 44	Triumph Adler 120	Viza Software 65
Bromcom 12/13	J	Jentech Computer Services 33	Juki (Europe) GmbH 28	Microware 152	Microprocessor Engineering Ltd 44	Triumph Adler 120	Wallingford Computing 170
Brother Industries 10/11	J	Jentech Computer Services 33	Juki (Europe) GmbH 28	Microware 152	Microprocessor Engineering Ltd 44	Triumph Adler 120	West One Galaxy 161
C	J	Jentech Computer Services 33	Juki (Europe) GmbH 28	Microware 152	Microprocessor Engineering Ltd 44	Triumph Adler 120	X
CAE Teleprinter Equipment 146	J	Jentech Computer Services 33	Juki (Europe) GmbH 28	Microware 152	Microprocessor Engineering Ltd 44	Triumph Adler 120	X-DATA Ltd 130/131
Calco Software 170	J	Jentech Computer Services 33	Juki (Europe) GmbH 28	Microware 152	Microprocessor Engineering Ltd 44	Triumph Adler 120	Z
Cambridge Electronic Design 115	J	Jentech Computer Services 33	Juki (Europe) GmbH 28	Microware 152	Microprocessor Engineering Ltd 44	Triumph Adler 120	Zedem Computer Ltd 22
Cambridge Microelectronics 64	J	Jentech Computer Services 33	Juki (Europe) GmbH 28	Microware 152	Microprocessor Engineering Ltd 44	Triumph Adler 120	
Cash + Carry Computers 163	J	Jentech Computer Services 33	Juki (Europe) GmbH 28	Microware 152	Microprocessor Engineering Ltd 44	Triumph Adler 120	
Central Micro Distribution 166	J	Jentech Computer Services 33	Juki (Europe) GmbH 28	Microware 152	Microprocessor Engineering Ltd 44	Triumph Adler 120	
Centronics Data Computers 53	J	Jentech Computer Services 33	Juki (Europe) GmbH 28	Microware 152	Microprocessor Engineering Ltd 44	Triumph Adler 120	
Cirtrik 162	J	Jentech Computer Services 33	Juki (Europe) GmbH 28	Microware 152	Microprocessor Engineering Ltd 44	Triumph Adler 120	
Commercial Data Systems 132	J	Jentech Computer Services 33	Juki (Europe) GmbH 28	Microware 152	Microprocessor Engineering Ltd 44	Triumph Adler 120	
Concordia 14	J	Jentech Computer Services 33	Juki (Europe) GmbH 28	Microware 152	Microprocessor Engineering Ltd 44	Triumph Adler 120	
Conguin Software 155	J	Jentech Computer Services 33	Juki (Europe) GmbH 28	Microware 152	Microprocessor Engineering Ltd 44	Triumph Adler 120	
Crown Business Centre 22	J	Jentech Computer Services 33	Juki (Europe) GmbH 28	Microware 152	Microprocessor Engineering Ltd 44	Triumph Adler 120	

Affordable and reliable printers from **Micro P** give you more **Quality** **CPS** for your money

MP Micro P
CPA 80 - 100 cps
+ EPSON COMPATIBLE
CPB 80 - 130 cps
+ IBM COMPATIBLE
FROM **£199***



MP Micro P
MP 165 - 165 cps
+ EPSON COMPATIBLE
NLQ PRINTER
FOR ABOUT **£269***



MP Micro P
CPP 40 - 4 COLOUR
PORTABLE
PRINTER/PLOTTER
FOR ABOUT **£79***

Even in today's high tech world, for most of us, the written word is still the least expensive means of sending and receiving information. If you own a microcomputer the chances are that sooner or later you are probably going to need a printer in order to get into print.

Micro P — CPP40

A low cost 4 colour 40/80 column printer/plotter capable of printing text or graphics on plain paper. The CPP40 is an ideal companion for small and portable micro's, as it is fitted with re-chargeable batteries — perfect for beginners.

Micro P — CPA80

With 100 cps quality printing, the CPA80 probably gives more cps/£ than any other printer available today. The CPA80 is packed with features you would normally find on a more expensive printer. With an optional RS232 version available (even for the QL) this Epson compatible printer will hook up to almost any micro.

Buy from your local dealer today!

● Circle No. 102

Micro P — MP165

Looking for a matrix printer as well as a daisywheel? Well, the MP165 combines all the attributes of these two technologies to give a matrix printer capable of printing at up to 165 cps, as well as providing crisp Near Letter Quality, (NLQ) print at 75 cps. Features include a 2k buffer as well as both friction and tractor feed, as standard. Ideally suited to most popular micro's, the MP165 is now available in a new RS232 QL compatible version.



**Micro
Peripherals Ltd**

179

"PRINTERS FOR ALL APPLICATIONS"

INTEC UNIT 3, HASSOCKS WOOD, WADE ROAD,
BASINGSTOKE, HANTS. ENGLAND, RG24 0NE.

Telephone: BASINGSTOKE (0256) 473232 (32 lines).

Telex: 859669 MICROP G Facsimile: 0256 461570

*Full 12 months warranty - RRP ex. VAT. QL is a registered Trade Mark of Sinclair Research.

With Quest the QL really means business



Executive Series



QL Expansion Console



Memory Expansion Board

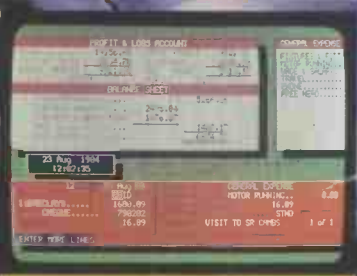

QL Cashtrader*



CP/M 68K



Disk Drive

Quest's Executive series of quality peripherals and software for the Sinclair QL allows the business and serious home user to fully realise the full potential of the most exciting computer of the 80's.

Post the coupon below to obtain details of a wide range of Quest Executive products including:

- CP/M 68K
- Business Accounting Software
- Floppy and Winchester Disk Drives
- Memory Expansion Boards
- Monitors
- Printers
- Consumables

Telephone Sales Desk 04215 66488

CP/M is a registered trademark of Digital Research
QL is a registered trademark of Sinclair Research

* Available from QL stockists or direct from Sinclair Research Ltd., Camberley (0276) 68311

Quest International Computers,
School Lane,
Chandlers Ford, Hants. SO5 3YY
Telex 47326.

Please send me details of the Quest Executive Series

Name 180 Tel. No. _____

Address _____ My QL Serial Number is _____

Position _____ ● Circle No. 178



Another leap forward
Quest